

I N D O O R

PAN

2 0 2 0 / 2 0 2 1

Panoramica / *Overview*

Smart Light	02
Light and Colors	10
Indice - <i>Product Index</i>	12
Pannelli Luminosi - <i>Light Panels</i>	18
Industriali - <i>Industrial Luminaires</i>	46
Stripled e Profili - <i>Stripled and Profiles</i>	70
Luce Lineare - <i>Linear Light</i>	124
Incassati - <i>Downlights</i>	196
Proiettori e Binari - <i>Spotlights and Tracks</i>	340
Plafoniere - <i>Ceiling Mounted</i>	376
Sospensioni - <i>Pendants</i>	396
A Parete - <i>Wall Mounted</i>	456
Da Terra- <i>Floor Lamps</i>	502
Da Tavolo - <i>Table Lamps</i>	526
Drivers e Controlli - <i>Drivers and Controllers</i>	542
Sorgenti Luminose - <i>Light Sources</i>	570

Smart Light

La luce accompagna la vita di tutti noi e sempre di più ne determina la qualità e il livello di benessere.

Questo è tanto più vero quanto la tecnologia attuale ha reso possibile la realizzazione di apparecchi di illuminazione sempre più intelligenti, in grado di produrre scenografie luminose dinamiche, personalizzabili e comodamente gestibili, ad esempio da smartphones o da interfacce sempre più user-friendly.

Smart Light di Pan rappresenta l'opportunità di realizzare tutto ciò che la luce e le moderne tecnologie, insieme, ci permettono di ottenere per migliorare la nostra qualità di vita.

Light accompanies the life of all of us and more and more determines its quality and level of well-being.

This is all the more true as current technology has made it possible to create even more intelligent lighting fixtures, capable of producing lighting scenes that can be dynamic, personalized and comfortably managed, for example by smartphones or more and more user-friendly interfaces.

Pan's Smart Light represents the opportunity to achieve all that light and modern technologies together allow us to obtain to improve our quality of life.



Smart Light

Il funzionamento delle Reti Mesh si basa sulla tecnologia wireless Bluetooth a basso consumo (Bluetooth Low Energy). La Mesh Network permette di replicare il flusso dati attraverso ogni nodo della rete (nodo = lampada, sensore, etc...); questi nodi, connessi fra loro, fanno sì che il sistema funzioni costantemente senza alcuna interruzione, e la fluidità dei dati è permessa dalle maglie prive di gerarchia. Nel caso in cui un nodo non funzioni, il sistema non si blocca, ma individua automaticamente una connessione alternativa, utilizzando gli altri nodi della rete. Ogni nodo può parlare con un altro nodo nell'area di copertura Bluetooth fino a un max di 15 mt di distanza in aria libera, ma l'utente può controllare anche un nodo distante più di 15m dal proprio dispositivo (ad es. il nodo più lontano all'interno della rete) utilizzando la connessione di nodi intermedi.

Rete mesh: utilizzo di drivers wireless Bluetooth

Mesh network: using wireless Bluetooth drivers

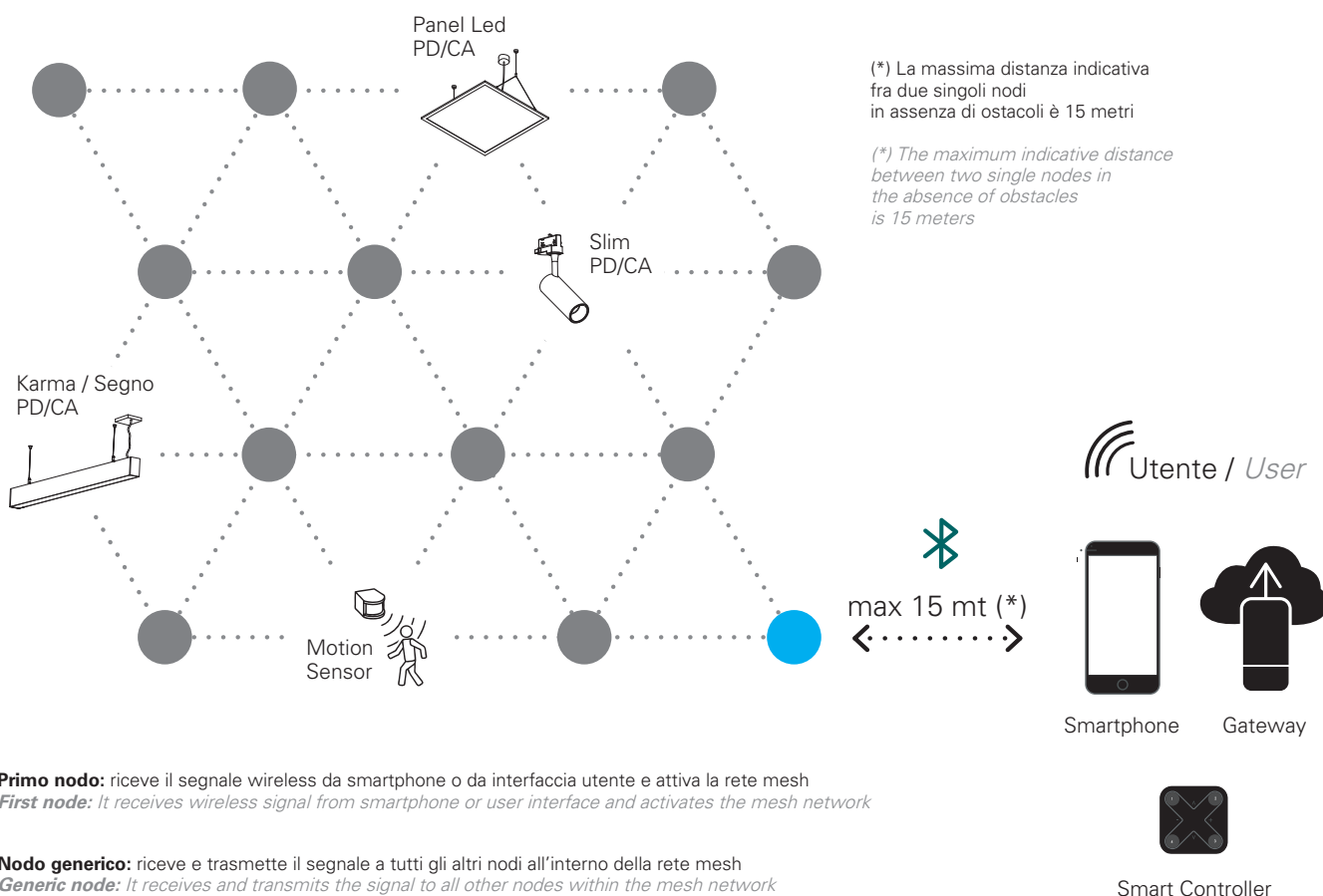

Impianti in Rete Mesh sono realizzabili solo con apparecchi di illuminazione equipaggiati con specifici driver digitali, idonei al trasferimento dati in modalità wireless Bluetooth. Questi si identificano con specifiche sigle da aggiungere come suffisso al codice standard, così come indicato nella tabella a fianco:

Mesh systems can only be made with lighting fixtures equipped with specific digital drivers, suitable for the data transfer in Bluetooth wireless mode. This fixtures are identified by specific abbreviations to be added as a suffix to the standard code, as indicated in the table on the opposite page:

The Mesh Networks are based on Bluetooth Low Energy wireless technology. The Mesh Network allows you to replicate the data flow through each node of the network (node = lamp, sensor, etc ...); these nodes, connected together, ensure that the system is able to operate constantly without any interruption, and the correct data flow is allowed by the meshes without hierarchy. In the case of a node no longer functions, the system does not stop to work, but automatically finds an alternative wifi connection, using the other nodes in the network. Each node can talk to another node in the Bluetooth coverage area up to a maximum distance of 15 meters without obstacles, but the user can also control a node more than 15 meters away from his device (e.g. the farrest node inside the network) using the connection of intermediate nodes.

Rete mesh: utilizzo di drivers DALI cablati e converters wireless Bluetooth

Mesh network: using wired DALI drivers and wireless Bluetooth converters

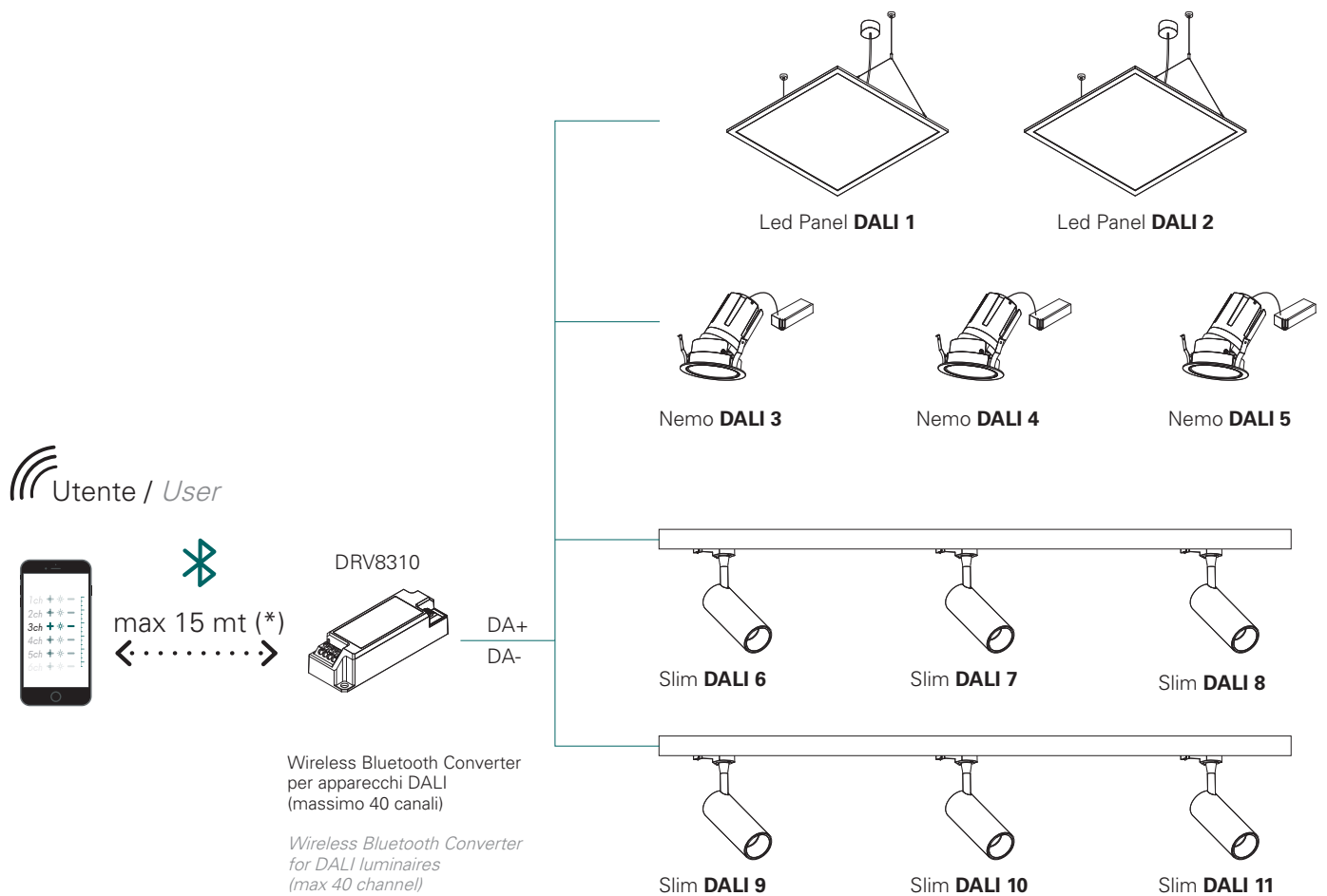

con controllo della luce wireless Bluetooth
wireless Bluetooth lighting control

versioni <i>version</i>	suffisso codice <i>code suffix</i>	nota <i>note</i>
PAN Digital	PD	per ordinare la versione per smart application PAN Digital aggiungere PD alla fine del codice to order the version for smart application PAN Digital add PD to the end of the code
CASAMBI	CA	per ordinare la versione per smart application CASAMBI aggiungere CA alla fine del codice to order the version for smart application CASAMBI add CA to the end of the code

Pan Digital

PAN Digital è la nuova applicazione smartphone di PAN per mobile IOS e Android che permette di gestire il proprio impianto di illuminazione da mobile.

PAN Digital is Pan's new smartphone application for IOS and Android that allows the management of your lighting system from mobile.



PAN Digital è intuitiva ed immediata; è particolarmente indicata per la gestione wireless della luce negli ambienti domestici, commerciali e di lavoro.

PAN Digital is intuitive and immediate; it is particularly suitable for wireless lighting management in rooms domestic ambients, commercial and work spaces.

PAN Digital permette la gestione degli apparecchi di illuminazione dedicati in modalità "rete mesh", senza l'utilizzo di router o connessioni internet.

PAN Digital allows management dedicated to lighting fixtures in "mesh network" mode, without using routers or internet connections.

rete mesh

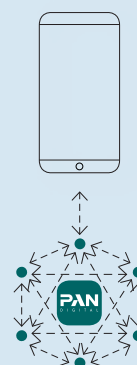

Con PAN Digital è possibile gestire l'impianto di illuminazione anche in ambiente Cloud; si possono ad esempio realizzare più reti, gestire più di 500 dispositivi all'interno della stessa rete, effettuare il backup di configurazione. Necessita di connessione internet.

Thanks to PAN Digital it is possible to manage the lighting system even in Cloud; for example, multiple networks can be created, more than 500 devices managed within the same network, to record configuration backup. Internet connection required.

Cloud

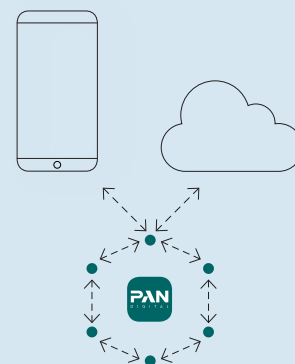



Con Pan Digital è possibile gestire accensione e dimmerazione di apparecchi a led monocromatici, Tunable, RGB e RGB+W, oltre che sensori per la rilevazione di presenza, di movimento, di calore o di luce diurna.

Thanks to Pan Digital it is possible to manage ignition and dimming of luminaires monochromatic, Tunable, RGB and RGB + W LEDs, as well as sensors for detecting presence, movement, heat or daylight.

Monochromatic



RGB



Tunable



RGB+W

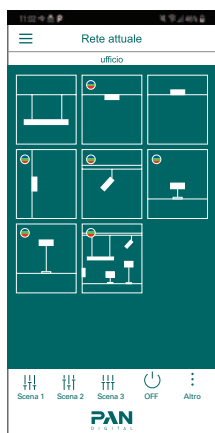

L'applicazione PAN Digital permette di impostare facilmente 10 scenari luminosi personalizzati e fino a 16 gruppi di apparecchi.

The PAN Digital application allows you to set up easily 10 personalized lighting scenarios and up to 16 groups of luminaires.

Pan Digital



Le soluzioni PAN Digital consente di ampliare la propria rete in qualunque momento e di funzionare anche in ambienti articolati, secondo le indicazioni descritte nelle pagine seguenti. La sicurezza dei sistemi è garantita da protocolli criptati tra device e dispositivi. La tecnologia Mesh, costantemente aggiornata nelle funzionalità, rappresenta la principale porta di accesso al mondo IoT. Pan Digital è particolarmente indicata per impianti di illuminazione sia per l'applicazioni professionali e retail che per gli ambienti domestici.

PAN Digital and Casambi solutions allow you to expand your network at any time, even in environments structured according to the indications following described in the next pages. Systems security is guaranteed by encrypted protocols between different devices. Mesh technology, constantly updated in functionality, represents the main gateway to the IoT. Pan Digital is particularly suitable for lighting systems for both professional and retail applications and also for domestic ambients.



Functionalities

- On/Off
- Dimming
- 10 Customisable scenarios
- Up to 16 user created groups
- Sensors setup
- Scheduling
- Dynamic scenarios
- Heat Maps
- View of contents and news

Luminary type

- 1 channel control (White)
- 2 channels control (TW)
- RGB control
- RGB+W control

Control type

- One by One
- Groups
- All together

Cloud services

- User account
- Administrator account
- Timed account (ex. hotels)
- Heat Maps storage and sharing
- Remote control
- Realttime News upload

Casambi



La soluzione Casambi si basa su Bluetooth Low Energy. Questa tecnologia offre la possibilità di implementare e sviluppare tutto il necessario per un sistema di controllo professionale dell'illuminazione, mostrando nell'interfaccia utente solo le funzionalità rilevanti per quella particolare installazione. Pertanto, l'app Casambi è adatta sia per il mercato dell'illuminazione professionale che per il settore residenziale.

Oltre all'app, è possibile utilizzare interruttori a parete tradizionali, pulsanti, controller di scena e molti altri punti di controllo.

The Casambi solution is based on Bluetooth Low Energy. This technology offers the possibility to implement and develop everything necessary for a professional lighting control system, showing only the functions relevant to that particular installation in the user interface. The Casambi app is suitable for both the professional lighting market and the residential sector. In addition to the app, traditional wall switches, buttons, scene controllers and many other control points can be used.



Functionalities

- On/Off
- Scenes
- Animations
- Gallery
- Sunrise & sunset
- Calendar & timer
- Colour temperature

Luminary type

- 1 channel control (White)
- 2 channels control (TW)
- RGB control
- RGB+W control

Control type

- Control hierarchy
- Grouping
- Scalability

Cloud services

- User account
- Account profiling
- Remote control
- Synchronization
- Gateway

Light and Colors

La classificazione CRI (Color Rendering Index) rappresenta un indice variabile su una scala 0-100 e sottintende la capacità di rendere fedelmente il colore di un oggetto illuminato; essa fa riferimento ad una scala di valori che prevede il campionamento di 14 colori di riferimento denominato Ra(14). Questi stessi colori vengono riportati su diagramma (CIE Lab del 1976 e seguenti) che ne evidenzia le coordinate e la comprensione delle diverse variabili cromatiche. Il modello Ra(14) è tutt'oggi ancora ampiamente utilizzato attraverso il suo indice CRI, ma è ormai assodato che esso presenta evidenti ed importanti limitazioni se applicato ai LED, per via della natura stessa dell'emissione di queste sorgenti.

Modelli di valutazione più attuali tendono ad aggiornarsi approfondendo più variabili rispetto al sistema di valutazione CRI, inclusa le preferenze dell'occhio dell'osservatore alle differenti qualità cromatiche rilevate. Solo a titolo di esempio, la saturazione di un colore può portare a scegliere una cromia e sfavorirne altre. Diverse sono le chiavi di lettura che si sono succedute: CQS, LRC con la Gamut area, fino ad arrivare al più recente ed affidabile metodo IES TM-30.

La sua ultima revisione IES TM-30-15 utilizza un campionamento di 99 colori derivati da elementi presenti in natura e, soprattutto, include valori legati all'analisi della saturazione sulla scena rappresentata. Mediante questo nuovo approccio metodologico si cerca di comporre un quadro quanto più fedele possibile nella restituzione dei colori percepiti. La IES TM-30 è quindi il più recente e affidabile sistema di valutazione che permette di qualificare una sorgente luminosa in funzione del suo effettivo utilizzo.

CRI

Resa del colore

Color rendering



CRI >70

Accettabile / *Acceptable*



CRI <90

Ottimale / *Optimal*



CRI >95

Eccellente / *Excellent*

The CRI (Color Rendering Index) classification represents a variable index on a 0-100 scale and implies the ability to faithfully render the color of an illuminated object; it refers to a scale of values which provides for the sampling of 14 reference colors called Ra(14). These same colors are shown on a diagram (CIE Lab of 1976 and following) which highlights their coordinates and understanding of the different chromatic variables. The Ra(14) model is still widely used today through its CRI index, but it is now established that it has evident and important limitations if applied to LEDs, due to the very nature of the emission of these sources.

More current evaluation models tend to update by deepening more variables than the CRI evaluation system, including the preferences of the observer's eye to the different chromatic qualities detected. As an example, the saturation of a color can lead to choosing a color scheme and disadvantaging others. There are several interpretative keys: CQS, LRC with the Gamut area, up to the most recent and reliable IES TM-30 method.

Its latest revision IES TM-30-15 uses a sampling of 99 colors derived from elements found in nature and, above all, includes values related to the analysis of saturation on the scene represented. Through this new methodological approach we try to compose a picture as faithful as possible in the restitution of the perceived colors. The IES TM-30 is therefore the most recent and reliable evaluation system that allows you to qualify a light source according to its actual use.

TM-30

Colori di riferimento TM-30 Reference colors TM-30



Diagrammi di riferimento TM-30 Reference diagrams TM-30

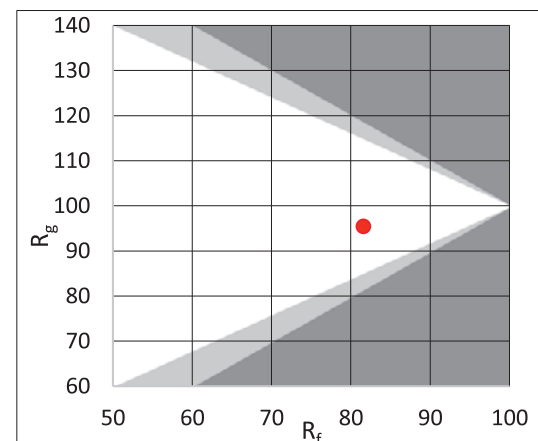
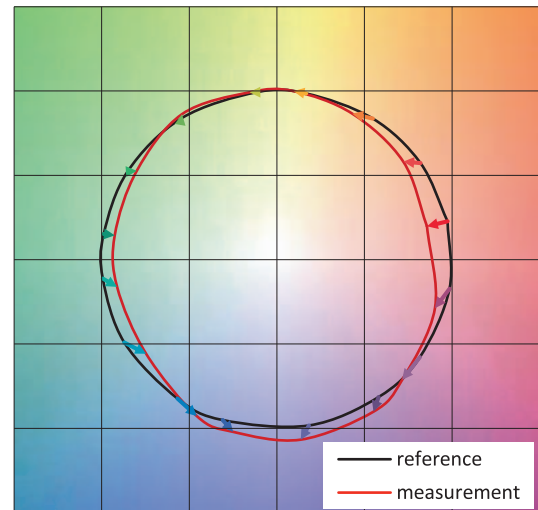

Indice

Product Index

Pannelli Luminosi - *Light Panels*



Backlit
p. 22



Backlit UGR
p. 24



Led Panel Smart
p. 30



Led Panel Microprismatic
p. 32



Led Panel IP65
p. 34



Led Panel Tunable
p. 36

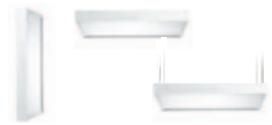

Panel Box
p. 44

Industriali - *Industrial Luminaires*



Puck Smart
p. 52



Puck Plus
p. 58



Lane
p. 64

Stripled e Profili - *Stripled and Profiles*



Mini
p. 76



CoB Line
p. 78



Light Line
p. 80



Light Line Waterproof
p. 84



High Efficiency
p. 86



Color Quality
p. 88



Tunable
p. 92



RGB - RGB+W
p. 94

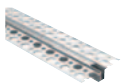

Profili Trimless
p. 106



Profili Trimmed
p. 111



Profili da Superficie
p. 116

Luce Lineare - *Linear Light*



Lybra
p. 126



Karma
p. 144



Segno Pendant
p. 166



Segno Ceiling
p. 172



Segno Wall
p. 178



Segno Trimless
p. 186



Steel Covers
p. 190

Incassati - *Downlights*



Egon
p. 200



Nemo
Adj / Fix
p. 218



Nemo
Comfort
p. 242



Nemo TL
Adj / Fix
p. 256



Nemo TL
Comfort
p. 264



Nemo
IP54
p. 270



Widot
p. 276



Widot
AS
p. 282



Moby
p. 286



Accent
p. 296



Bobby
p. 302



Jango
p. 308



Show
IP65
p. 312



Shop
p. 316



Single
p. 320



Turn
AS
p. 321



Focus
p. 322



Pill
p. 326



Microled
Miniled
p. 328



Odino
p. 334



Song
p. 334



Ettore
p. 336



Enea
p. 336



Priamo
IP65
p. 337



Paride
p. 338



Gesso
Plaster

Proiettori e Binari - *Spotlights and Tracks*



Slim
p. 334



Ska
p. 356



Ska
Base
p. 368



Day
p. 370

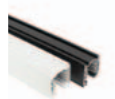

Track 4
p. 372

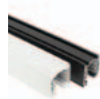

Track 6 Digital
p. 374

Plafoniere - *Ceiling Mounted*



Hoop
Ceiling
p. 378



Corona
Ceiling
p. 380



Kart
Ceiling
p. 382



Bike
Ceiling
p. 384



Penny
Ceiling
p. 386



Play
p. 388



Dama
p. 390



Young
p. 392



Gipsy
p. 393



Orion
p. 394

Sospensioni - *Pendants*



Hoop
Pendant
p. 398



Corona
Pendant
p. 400



Kart
Pendant
p. 402



Bike
Pendant
p. 404



Penny
Pendant
p. 408



Giove
p. 416



Saturno
p. 418



Urano
p. 422



Etna
p. 424



Archer
p. 426



Stek
p. 428



Lupin
Pendant
p. 430



Cross
p. 434



Lunar
Pendant
p. 436



Elmet
p. 438



Medea
p. 440



Urban
Pendant
p. 442



Bay
p. 444



Bond
p. 446



Bugle
p. 448



Minimal
p. 450





































Brio
p. 452



Rod
p. 454

A Parete - *Wall Mounted*

							
Match	Fair	Onda	Elle	Tablet	Grace	Orion	Spillo
p. 458	p. 460	p. 462	p. 463	p. 464	p. 465	p. 466	p. 467
							
Pod	Boreale	Idra	Tube	Oberon	Polaris	Eli	Gesso Plaster
p. 468	p. 469	p. 470	p. 471	p. 472	p. 473	p. 474	
							
Eclis	Fast	Polka	Lupin	Barro	Dippy	Pako	Professional
p. 475	p. 478	p. 480	p. 482	p. 484	p. 486	p. 487	p. 488
							
Berlin	London	Paris	Cama	Soft	Jazz		
p. 492	p. 493	p. 494	p. 495	p. 496	p. 497		
							
Tina	Emma	Susy	Giuly				
p. 498	p. 499	p. 500	p. 501				

Da Terra - *Floor Lamps*



Stem
p. 504



Oslo
Floor
p. 505



Lunar
Floor
p. 506



Rod
Floor
p. 508



Soft
Floor
p. 510



Inge
p. 512



Bow
p. 514



Shade
p. 518



Maiko
p. 520



Zaria
p. 522



Night
p. 524



Loft
p. 525

Da Tavolo - *Table Lamps*



Soft
Table
p. 528



Oslo
Table
p. 529



Mikka
p. 530



Milla
p. 532



Urban
Table
p. 534



Yab
p. 536



Alter
p. 538



Summer
p. 540



Mida
p. 541

Pannelli Luminosi

Light Panels



Backlit

p.20

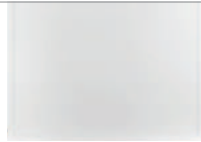

Backlit

UGR

p.24

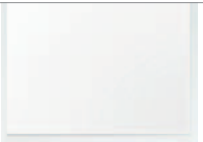

Led Panel

Smart

p.30

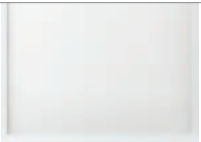

Led Panel

Microprismatic

p.32



Led Panel

High Protection IP65

p.34

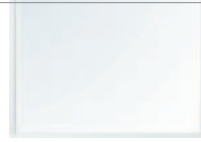

Led Panel

Tunable

p.36



Panel Box

p.44

Backlit

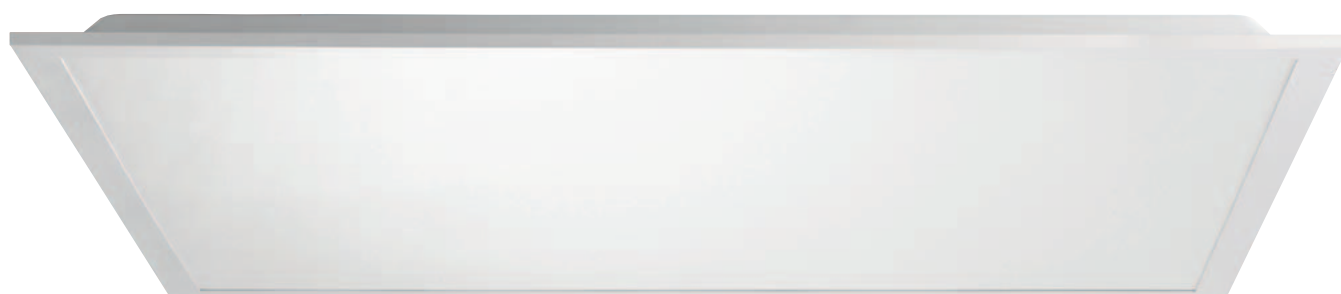

 ^{UP TO} 94 lm / W ^{UP TO} UGR < 19 L80 / B20 50.000 h.

Backlit è un apparecchio a led di ultima generazione che si distingue per economicità, efficacia luminosa ed affidabilità nel tempo. Le sorgenti led posizionate sul retro dell'apparecchio emettono luce direttamente verso il basso ottenendo così le migliori prestazioni in condizioni termiche ottimali ed allungando la vita utile dei led il più possibile. Backlit si utilizza in appoggio all'interno di controsoffitti modulari oppure in abbinamento con le soluzioni Modular System per l'installazione a plafone o a sospensione. Backlit è disponibile anche nelle versioni UGR<19.

Backlit is a latest generation LED fixture that stands out for its economy, luminous efficacy and reliability over time. The LED sources located on the back of the appliance emit light directly downwards to obtain the best performance in optimal operating conditions, making sources lifetime as longer as possible. Backlit can be installed as a recessed lighting panel for modular false ceilings or as pendant or ceiling mounted if matched with Modular System's boxes solutions.

- Dimensioni in gamma 60x60 / 30x120 / 60x120 cm.
- Installabile in appoggio in controsoffitti modulari; a incasso trimmed o trimless, a sospensione, a plafone con appositi accessori (non inclusi)
- Alimentazione 220÷240 V / 50÷60 Hz - Classe "II"
- Accensione On / Off – Dimmerabile DALI / PUSH / 1...10 V
- Versioni con controllo digitale "Casambi" o "Pan Digital System (solo per modello UGR)
- Kit Emergenza 1h. e 3h. accessorio (non incluso)
- Alimentatore "no flickering" incluso
- Colore bianco
- IP20 / IK03
- led SMD 3000 K e 4000 K con resa cromatica CRI > 80
- Lenti ottiche tipo "One to Led"
- No UV, No IR
- Emissioni luminose da 3070 a 5500 lumen
- Efficacia luminosa fino a 94 lm/W
- Efficienza energetica A
- Lifetime L80 / B20 – 50.000 h.
- Ottiche 120° e 90° UGR<19
- Temperatura ambiente di esercizio da 0°C a +45°C
- Certificazione CE, RoHS
- 3 anni di garanzia

- *Dimensions 60x60 / 30x120 / 60x120 cm.*
- *False ceiling rest mounting; recessed trimmed or trimless pendant, ceiling or wall mounting thanks to clips as accessories (not included)*
- *Feeding 220÷240 V / 50÷60 Hz – Class "II"*
- *Driver "no flickering" included*
- *Switching On / Off – Dimmable DALI / PUSH / 1...10 V*
- *Digital Control Versions "Casambi" or "Pan Digital System" (only for model UGR)*
- *Emergency Kit 1h. or 3h. as accessory (not included)*
- *Frame color matt white*
- *IP20 / IK03*
- *Led SMD 3000 K or 4000 K; CRI > 80*
- *No UV, No IR*
- *Light output from 3070 lm up to 5500 lm*
- *Optic lenses "One to Led"*
- *Efficacy up to 94 lm/W*
- *Energy Label A*
- *Lifetime L80 / B20 – 50.000 h.*
- *Optics 120° and 90° UGR<19*
- *Operation 0°C a +45°C*
- *Declaration CE, RoHS*
- *Warranty 3 years*

Backlit



90 lm / W

L80 / B20 50.000 h.



3 YEARS WARRANTY

Le sorgenti led, posizionate sul fondo del pannello ed abbinata a lenti ottiche di tipo "one to led", emettono la totalità del flusso luminoso nella direzione utile e operano nelle migliori condizioni termiche possibili, ottimizzando il rendimento luminoso e preservando la vita utile del led nel tempo.

(Light Output Maintenance L80/B20 50.000h).

The LED sources, positioned on the bottom of the panel and combined with "one to led" optical lenses, emit the totality of luminous flux in the right direction and operate in the best possible thermal conditions, optimizing luminous performance and preserving the life of the LED over time.

(Light Output Maintenance L80 / B20 50.000h).

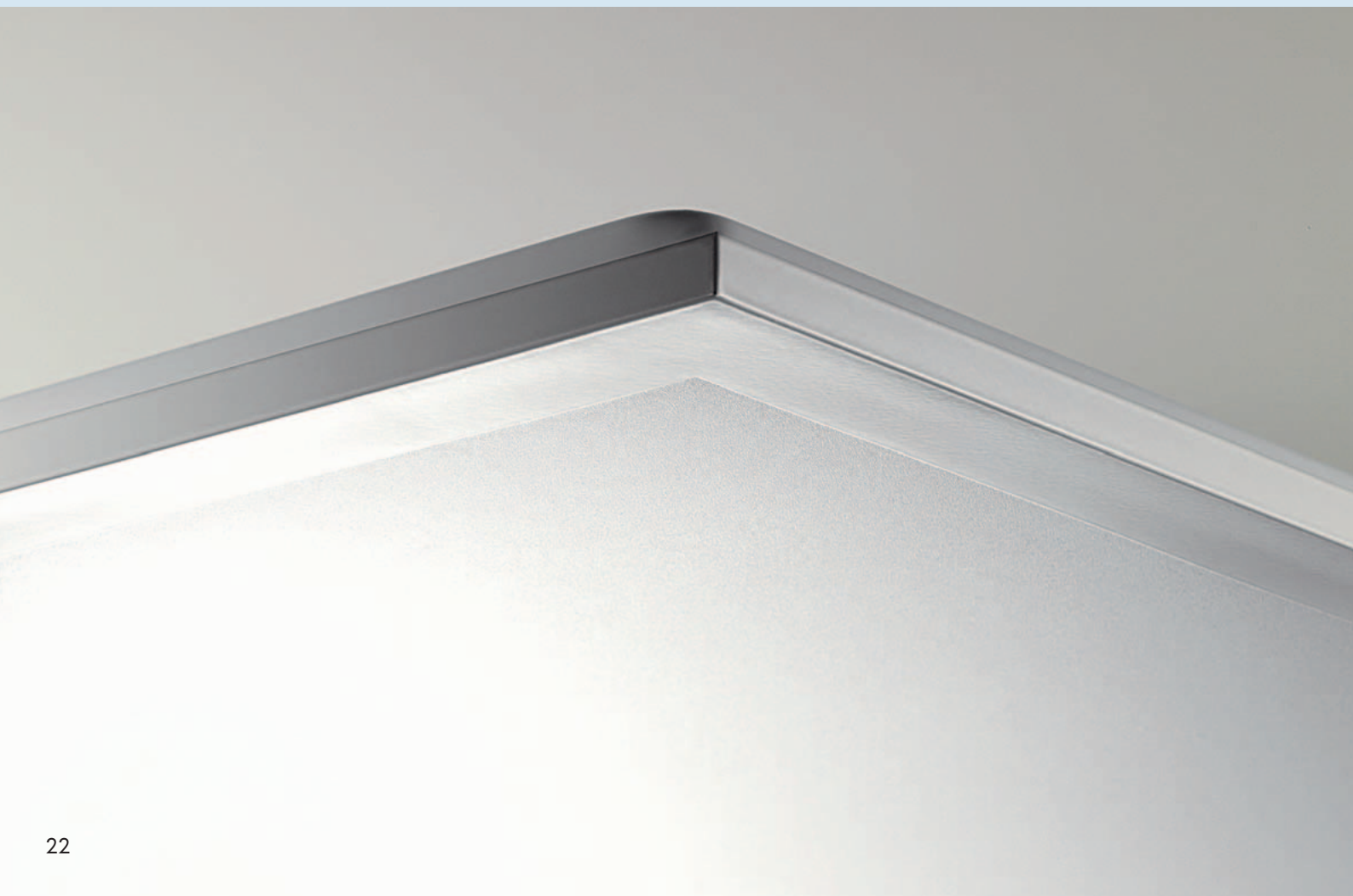
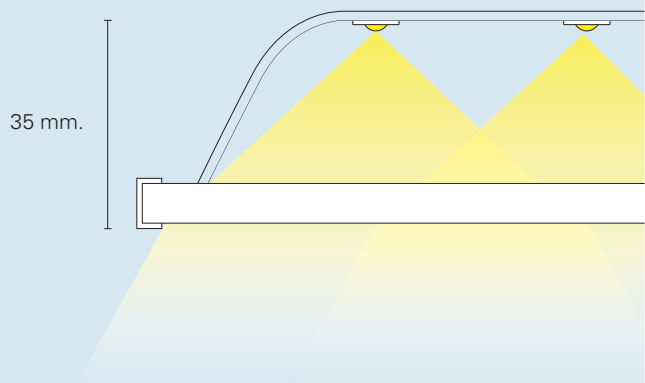

Dimensioni / Dimensions

60x60

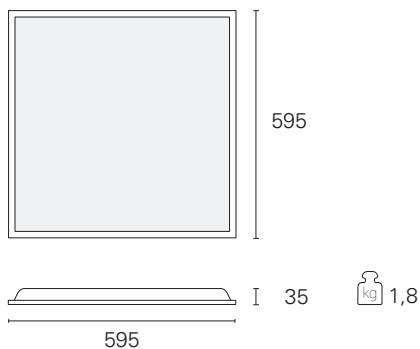

Ottiche / Optics

60x60 120° 4000 K

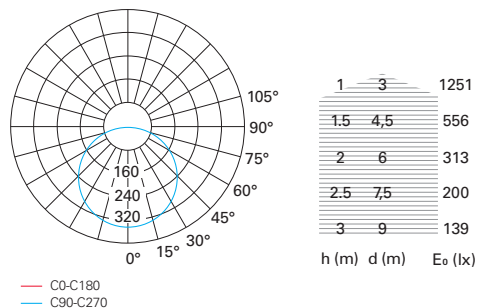

BACKLIT

CRI 80

dimensioni size	versione version	potenza power	codice code	CCT CCT	flusso apparecchio light output	UGR UGR	ottica optic	colore colour
60x60	On / Off	40 W	BAC56040	3000 K	3315 lm	≤ 22	120°	bianco / white
	220 ÷ 240 V		BAC56041	4000 K	3600 lm	≤ 22	120°	bianco / white

vedi accessori di installazione PANEL BOX a pg. 44.
see installing accessories PANEL BOX to pg 44.



Accessori / Dimensions

vedi modalità di installazione a pg. 38.
see mounting operation to pg 38.

Kit Trimmed Recessed

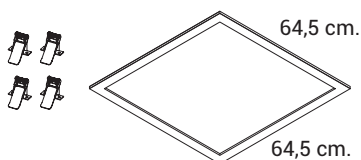

Kit Trimless Recessed

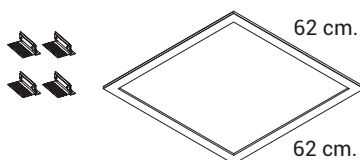

INC1283

Telaio bianco per installazione ad incasso completo di clips.

White frame for recessed panel installation with clips.

INC1290

Telaio bianco per incasso a filo in cartongesso con cornice a scomparsa completo di staffe.

White frame for trimless mounting on plasterboard with brackets and retractable frames.

Backlit UGR



94 lm / W UGR < 19 L80 / B20 50.000 h.



3 YEARS WARRANTY

Backlit UGR è il pannello ideale per gli impianti di illuminazione che devono garantire un attento controllo delle luminanze; grazie all'abbinamento fra le lenti "one to led" e lo schermo microprismatizzato, la sua emissione UGR<19 lo rende conforme alle normative EN per l'illuminazione degli ambienti di lavoro. Le sorgenti led, opportunamente posizionate all'interno del pannello, smaltiscono il calore nel miglior modo possibile ed emettono luce direttamente attraverso lo schermo prismatizzato, ottenendo elevate performances senza compromettere l'affidabilità nel tempo.

Backlit UGR is the ideal panel for lighting systems that guarantee careful luminance control; thanks to the combination of "one to led" lenses and the micro-prismatic screen, its UGR <19 emission makes it compliant with EN standards for lighting in the workplace. The LED sources, suitably positioned inside the panel, dissipate the heat in the best possible way and emit light directly through the microprismatic screen, obtaining high performances without compromising reliability over time.

Dimensioni / Dimensions

60x60

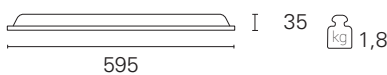
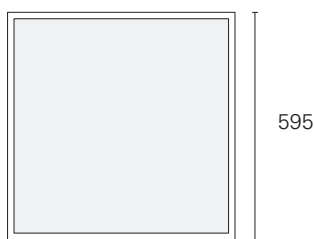

30x120

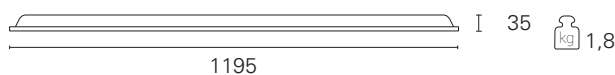

60x120

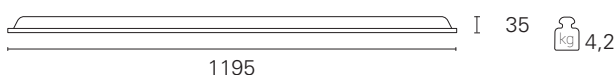

Ottiche / Optics

60x60 - 90° UGR<19 - 4000 K

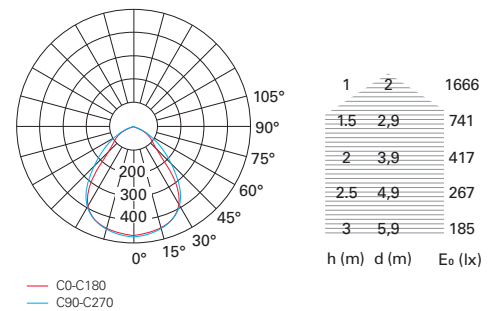

30x120 - 90° UGR<19 - 4000 K

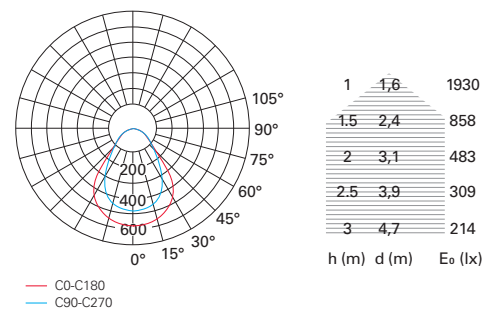

60x120 - 90° UGR<19 - 4000 K

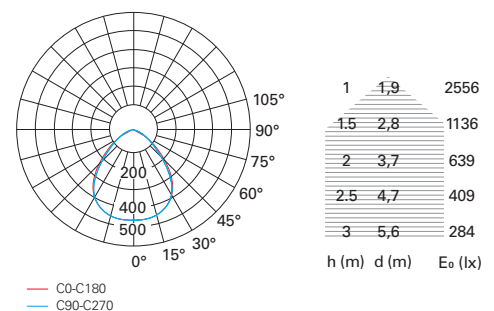

Backlit UGR<19

CRI 80

dimensioni size	versione version	potenza power	codice code	CCT CCT	flusso apparecchio light output	UGR UGR	ottica optic	colore colour
60x60	On / Off	36 W	BAC56140	3000 K	3105 lm	< 19	90°	bianco / white
	220 ÷ 240 V		BAC56141	4000 K	3375 lm	< 19	90°	bianco / white
	Dimm 1...10 V / PUSH / DALI	36 W	BAC56140DM	3000 K	3105 lm	< 19	90°	bianco / white
	220 ÷ 240 V		BAC56141DM	4000 K	3375 lm	< 19	90°	bianco / white
30x120	On / Off	36 W	BAC56142	3000 K	3075 lm	< 19	90°	bianco / white
	220 ÷ 240 V		BAC56143	4000 K	3340 lm	< 19	90°	bianco / white
	Dimm 1...10 V / PUSH / DALI	36 W	BAC56142DM	3000 K	3075 lm	< 19	90°	bianco / white
	220 ÷ 240 V		BAC56143DM	4000 K	3340 lm	< 19	90°	bianco / white
60x120	On / Off	60 W	BAC56144	3000 K	5080 lm	< 19	90°	bianco / white
	220 ÷ 240 V		BAC56145	4000 K	5520 lm	< 19	90°	bianco / white
	Dimm 1...10 V / PUSH / DALI	60 W	BAC56144DM	3000 K	5080 lm	< 19	90°	bianco / white
	220 ÷ 240 V		BAC56145DM	4000 K	5520 lm	< 19	90°	bianco / white

vedi accessori di installazione PANEL BOX a pg. 44.
see installing accessories PANEL BOX to pg 44.



Versioni dimmerabili / Dimmable versions

con controllo della luce wireless Bluetooth
wireless Bluetooth lighting control

versioni version	suffisso codice code suffix	nota note	esempio example
PAN Digital	PD	per ordinare la versione per smart application PAN Digital aggiungere PD alla fine del codice to order the version for smart application PAN Digital add PD to the end of the code	BAC-----PD
CASAMBI	CA	per ordinare la versione per smart application CASAMBI aggiungere CA alla fine del codice to order the version for smart application CASAMBI add CA to the end of the code	BAC-----CA

versioni Bluetooth per "smart application"; vedi dettagli alle pagine 8 - 9
Bluetooth versions for "smart application"; see details to pages 8 - 9

Kit Emergenza / Emergency Kit

autonomia operation time	tempo di accensione switching time	tempo di ricarica recharging time	foro di incasso minimo (*) minimum recessing hole (*)	IP IP	peso weight	codice code
1 ora / 1 hour	0,5 sec.	24 h.	Ø 75 mm.	IP20	0,43 kg	DRV9092
3 ora / 3 hour	0,5 sec.	24 h.	Ø 100mm.	IP20	0,88 kg	DRV9091

(*) per l'installazione in controsoffitto verificare la compatibilità con il foro di incasso; vedi dettagli a pagina 546
(* for installation in false ceiling check the compatibility with the recessing hole; see details to page 546)

Accessori / Dimensions - solo per modello 60x60 - only for 60x60 model

vedi modalità di installazione a pg. 38.
see mounting operation to pg 38.

Kit Trimmed Recessed

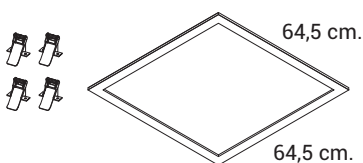

INC1283

Telaio bianco per installazione ad incasso completo di clips.
White frame for recessed panel installation with clips.

Kit Trimless Recessed

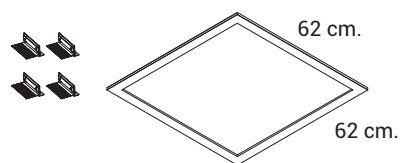

INC1290

Telaio bianco per incasso a filo in cartongesso con cornice a scomparsa completo di staffe.
White frame for trimless mounting on plasterboard with brackets and retractable frames.

Led Panel





Led Panel

 ^{UP TO} 110 lm/W ^{UP TO} UGR < 17/19 L80/B20 50.000 h.

Led Panel è una famiglia di apparecchi a led di ultima generazione studiati per l'illuminazione di ambienti destinati alle attività professionali e al retail. All'interno della famiglia Led Panel specifiche linee di prodotto offrono soluzioni illuminotecniche per ogni tipo di applicazione, assicurando sempre performance illuminotecniche e prestazioni energetiche ottimali.

Completano la famiglia Led Panel una vasta gamma di accessori per tutte le principali tipologie di installazione

Led Panel is a family of latest generation LED devices, designed for the illumination of professional and retail environments. Within the Led Panel family, specific product lines offer lighting solutions for all types of applications, which always ensure optimum lighting and energy performance. The Led Panel family includes a wide range of accessories for all the main types of installations.

- Dimensioni in gamma 60x60 / 62x62 / 30x30 / 30x60 / 30x120 / 60x120 cm.
- Installabile in appoggio in controsoffitti modulari;
- Installabile a incasso trimmed o trimless, a semiincasso, a sospensione, a plafone e a parete con appositi accessori (non inclusi)
- Alimentazione 220÷240 V / 50÷60 Hz - Classe "II"
- Accensione On / Off – Dimmerabile DALI / PUSH / 1...10 V.
- Versioni con controllo digitale "Casambi" o "Pan Digital System (solo per modelli Smart / Microprismatic / Tunable)
- Kit Emergenza 1h. e 3h. accessorio (non incluso)
- Alimentatore "no flickering" incluso
- Colore bianco
- IP20 / IP65 versione High Protection
- led SMD 3000 K e 4000 K con resa cromatica CRI > 80 o CRI > 90
- No UV, No IR
- Emissioni luminose da 1420 a 6360 lumen
- Efficacia luminosa fino a 110 lm/W
- Efficienza energetica A
- Lifetime L80 / B20 – 50.000 h. / L70 / B20 - 36.000 h.
- Ottiche 120°, 90° UGR<19, 75° UGR<17
- Temperatura ambiente di esercizio da 0°C a +40°C
- Certificazione CE, RoHS
- 3 / 5 anni di garanzia

- *Dimensions 60x60 / 62x62 / 30x30 / 30x60 / 30x120 / 60x120 cm.*
- *False ceiling rest mounting*
- *recessed trimmed or trimless, semirecessed, pendant, ceiling or wall mounting thanks to clips as accessories (not included);*
- *Feeding 220÷240 V / 50÷60 Hz – Class "II"*
- *Driver "no flickering" included,*
- *Switching On / Off – Dimm. DALI / PUSH / 1...10 V.*
- *Digital Control Versions "Casambi" or "Pan Digital System" (only for models Smart / Microprismatic / Tunable)*
- *Emergency Kit 1h. or 3h. as accessory (not included)*
- *Frame color matt white*
- *IP20 / IK65 High Protection version*
- *Led SMD 3000 K or 4000 K; CRI > 80 or CRI > 90*
- *No UV, No IR*
- *Light output from 1420 lm up to 6360 lm*
- *Efficacy up to 110 lm/W*
- *Energy Label A*
- *Lifetime L80 / B20 – 50.000 h. / L70 / B20 - 36.000 h.*
- *Optics 120°, 90° UGR<19, 75° UGR<17*
- *Operation 0°C a +40°C*
- *Declaration CE, RoHS*
- *Warranty 3 / 5 years*

Led Panel Smart



☐ 110lm/W UGR < 19 L80 / B20 50.000 h.



5 YEARS WARRANTY

La linea Led Panel Smart presenta un'ampia gamma di versioni per potenze, temperature di colore e alimentazioni. Tutte le versioni sono caratterizzate da un elevato controllo delle emissioni luminose per garantire il massimo comfort visivo con valori di UGR<19 e dalla totale assenza di flickering.

The Led Panel Smart line is offered in a wide range of versions, in terms of output, colour temperatures and power supplies. All versions are characterized by enhanced luminous emission control to ensure maximum visual comfort, with a UGR < 19 and the complete absence of flicker.

Dimensioni / Dimensions

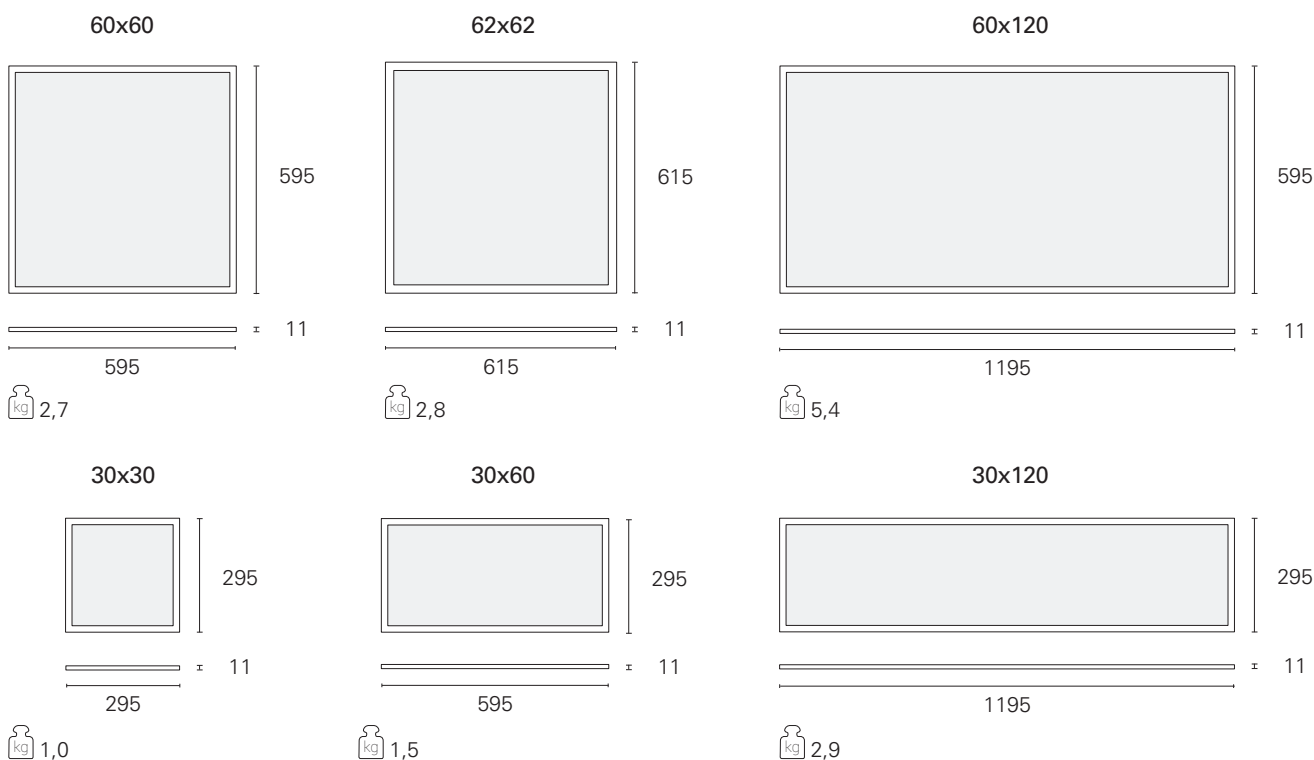

Ottiche / Optics

60x60 - 120° UGR<19 - 4000 K

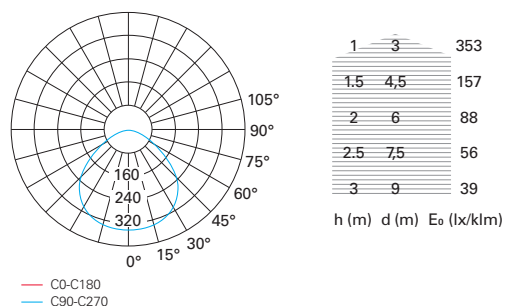

Versioni dimmerabili / Dimmable versions

con controllo della luce wireless Bluetooth
wireless Bluetooth lighting control

versioni version	suffisso codice code suffix	nota note	esempio example
PAN Digital	PD	per ordinare la versione per smart application PAN Digital aggiungere PD alla fine del codice <i>to order the version for smart application PAN Digital add PD to the end of the code</i>	INC-----PD
CASAMBI	CA	per ordinare la versione per smart application CASAMBI aggiungere CA alla fine del codice <i>to order the version for smart application CASAMBI add CA to the end of the code</i>	INC----CA

versioni Bluetooth per "smart application"; vedi dettagli alle pagine 8 - 9
Bluetooth versions for "smart application"; see details to pages 8 - 9

Led Panel Smart

CRI > 80

dimensioni size	versione version	potenza power	codice code	CCT CCT	flusso apparecchio light output	UGR UGR	ottica optic	colore colour
60x60	On / Off 220 ÷ 240 V	36 W	INC1235	3000 K	3400 lm	≤ 19	120°	bianco / white
			INC1228	4000 K	3850 lm	≤ 19	120°	bianco / white
		50 W	INC1231	3000 K	4700 lm	≤ 19	120°	bianco / white
			INC1225	4000 K	5100 lm	≤ 19	120°	bianco / white
	Dimm 1...10 / PUSH / DALI 220 ÷ 240 V	36 W	INC1236	3000 K	3400 lm	≤ 19	120°	bianco / white
			INC1229	4000 K	3850 lm	≤ 19	120°	bianco / white
		50 W	INC1233	3000 K	4700 lm	≤ 19	120°	bianco / white
			INC1226	4000 K	5100 lm	≤ 19	120°	bianco / white
62x62	On / Off 220 ÷ 240 V	36 W	INC1278	3000 K	3400 lm	≤ 19	120°	bianco / white
			INC1276	4000 K	3850 lm	≤ 19	120°	bianco / white
		50 W	INC1279	3000 K	4700 lm	≤ 19	120°	bianco / white
			INC1277	4000 K	5100 lm	≤ 19	120°	bianco / white
	Dimm 1...10 / PUSH / DALI 220 ÷ 240 V	36 W	INC1278D	3000 K	3400 lm	≤ 19	120°	bianco / white
			INC1276D	4000 K	3850 lm	≤ 19	120°	bianco / white
		50 W	INC1279D	3000 K	4700 lm	≤ 19	120°	bianco / white
			INC1277D	4000 K	5100 lm	≤ 19	120°	bianco / white
60x120	On / Off 220 ÷ 240 V	60 W	INC1243	3000 K	6000 lm	≤ 19	120°	bianco / white
			INC1240	4000 K	6360 lm	≤ 19	120°	bianco / white
	Dimm 1...10 / PUSH / DALI 220 ÷ 240 V	60 W	INC1244	3000 K	6000 lm	≤ 19	120°	bianco / white
			INC1241	4000 K	6360 lm	≤ 19	120°	bianco / white
30x30	On / Off 220 ÷ 240 V	18 W	INC1273	3000 K	1420 lm	≤ 19	120°	bianco / white
			INC1270	4000 K	1550 lm	≤ 19	120°	bianco / white
	Dimm 1...10 / PUSH / DALI 220 ÷ 240 V	18 W	INC1274	3000 K	1420 lm	≤ 19	120°	bianco / white
			INC1271	4000 K	1550 lm	≤ 19	120°	bianco / white
30x60	On / Off 220 ÷ 240 V	36 W	INC1263	3000 K	3450 lm	≤ 19	120°	bianco / white
			INC1260	4000 K	3920 lm	≤ 19	120°	bianco / white
	Dimm 1...10 / PUSH / DALI 220 ÷ 240 V	36 W	INC1264	3000 K	3450 lm	≤ 19	120°	bianco / white
			INC1261	4000 K	3920 lm	≤ 19	120°	bianco / white
30x120	On / Off 220 ÷ 240 V	36 W	INC1253	3000 K	3850 lm	≤ 19	120°	bianco / white
			INC1250	4000 K	4130 lm	≤ 19	120°	bianco / white
	Dimm 1...10 / PUSH / DALI 220 ÷ 240 V	36 W	INC1254	3000 K	3850 lm	≤ 19	120°	bianco / white
			INC1251	4000 K	4130 lm	≤ 19	120°	bianco / white

vedi accessori di fissaggio a pg. 38 / see mounting accessories to pg. 38.

Led Panel Smart

CRI > 90

60x60	On / Off 220 ÷ 240 V	36 W	INC56503	3000 K	3260 lm	≤ 19	120°	bianco / white
			INC56500	4000 K	3720 lm	≤ 19	120°	bianco / white
	Dimm 1...10 / PUSH / DALI 220 ÷ 240 V	36 W	INC56504	3000 K	3260 lm	≤ 19	120°	bianco / white
			INC56501	4000 K	3720 lm	≤ 19	120°	bianco / white
30x120	On / Off 220 ÷ 240 V	36 W	INC56527	3000 K	3970 lm	≤ 19	120°	bianco / white
			INC56524	4000 K	3700 lm	≤ 19	120°	bianco / white
	Dimm 1...10 / PUSH / DALI 220 ÷ 240 V	36 W	INC56528	3000 K	3970 lm	≤ 19	120°	bianco / white
			INC56525	4000 K	3700 lm	≤ 19	120°	bianco / white

vedi accessori di fissaggio a pg. 38 / see mounting accessories to pg. 38.

Kit Emergenza / Emergency Kit

autonomia operation time	tempo di accensione switching time	tempo di ricarica recharging time	foro di incasso minimo (*) minimum recessing hole (*)	IP IP	peso weight	codice code
1 ora / 1 hour	0,5 sec.	24 h.	Ø 75 mm.	IP20	0,43 kg	DRV9092
3 ora / 3 hour	0,5 sec.	24 h.	Ø 100mm.	IP20	0,88 kg	DRV9091

(*) per l'installazione in controsoffitto verificare la compatibilità con il foro di incasso; vedi dettagli a pagina 546
(* for installation in false ceiling check the compatibility with the recessing hole; see details to page 546)

Led Panel Microprismatic



Compliance
EN 12464-1

UP TO 110lm/W UP TO UGR < 17 L80/B20 50.000h.



5 YEARS WARRANTY

Panel Led Microprismatic è equipaggiato con il nuovo pannello "Glareless" costituito da uno speciale schermo microprismatico a 3 strati, il quale recupera il 20% in più del flusso emesso e riduce l'abbagliamento, garantendo un valore di UGR<17. Comfort visivo ottimale e assenza di flickering rendono Panel Led Microprismatic l'apparecchio idoneo per l'illuminazione degli ambienti dedicati alle attività lavorative dove si utilizzano monitor e computer portatili.

Micro prismatic Led Panel is fitted with the latest "Glareless" panel, which consists of a special prismatic 3 layer screens that harvests 20% more of the flux emitted and reduces glare, ensuring that a UGR value < 17. Optimal visual comfort and no flickering make Panel Led devices suitable for the lighting of environments dedicated to working activities where monitors and laptops are used.

Dimensioni / Dimensions

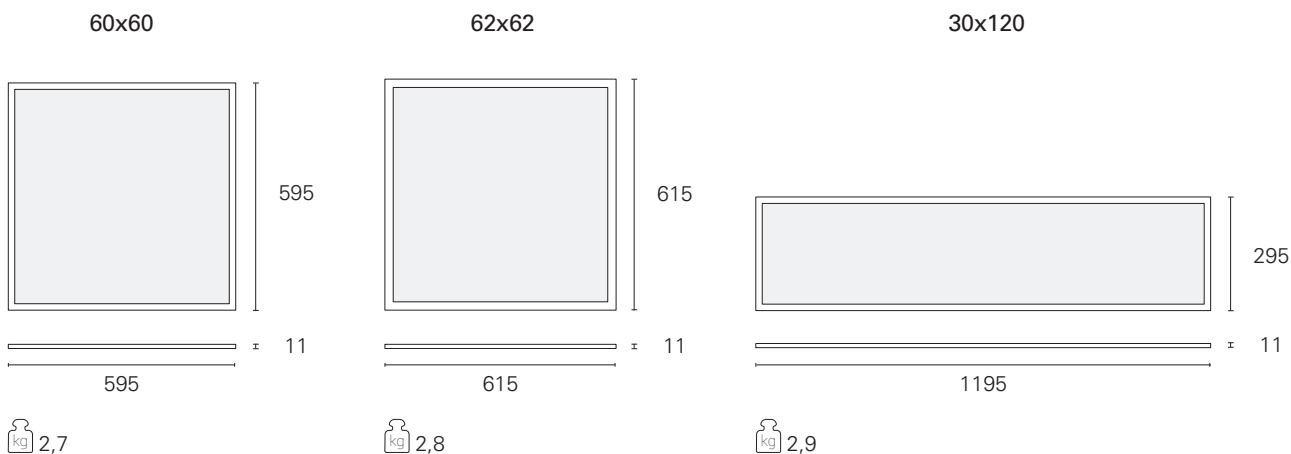

Ottiche / Optics

60x60 - 75° UGR<17 - 4000 K

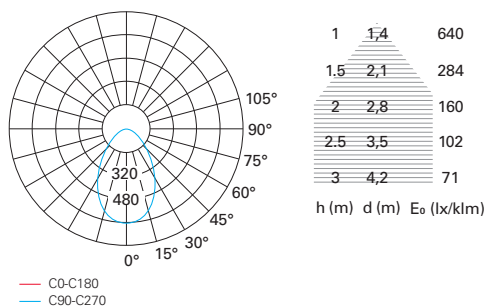

UGR<17

No Glare

High visual comfort

Led Panel Microprismatic

CRI > 80

dimensioni size	versione version	potenza power	codice code	CCT CCT	flusso apparecchio light output	UGR UGR	ottica optic	colore colour
60x60	On / Off	36 W	INC56244	3000 K	3500 lm	≤ 17	75°	bianco / white
	220 ÷ 240 V		INC56241	4000 K	3960 lm	≤ 17	75°	bianco / white
	Dimm 1...10 / PUSH / DALI	36 W	INC56245	3000 K	3500 lm	≤ 17	75°	bianco / white
	220 ÷ 240 V		INC56242	4000 K	3960 lm	≤ 17	75°	bianco / white
62x62	On / Off	36 W	INC56256	3000 K	3500 lm	≤ 17	75°	bianco / white
	220 ÷ 240 V		INC56253	4000 K	3960 lm	≤ 17	75°	bianco / white
	Dimm 1...10 / PUSH / DALI	36 W	INC56257	3000 K	3500 lm	≤ 17	75°	bianco / white
	220 ÷ 240 V		INC56254	4000 K	3960 lm	≤ 17	75°	bianco / white
30x120	On / Off	36 W	INC56250	3000 K	3500 lm	≤ 17	75°	bianco / white
	220 ÷ 240 V		INC56247	4000 K	3960 lm	≤ 17	75°	bianco / white
	Dimm 1...10 / PUSH / DALI	36 W	INC56251	3000 K	3500 lm	≤ 17	75°	bianco / white
	220 ÷ 240 V		INC56248	4000 K	3960 lm	≤ 17	75°	bianco / white

vedi accessori di fissaggio a pg. 38 / see mounting accessories to pg 38.

Versioni dimmerabili / Dimmable versions

con controllo della luce wireless Bluetooth
wireless Bluetooth lighting control

versioni version	suffisso codice code suffix	nota note	esempio example
PAN Digital	PD	per ordinare la versione per smart application PAN Digital aggiungere PD alla fine del codice to order the version for smart application PAN Digital add PD to the end of the code	INC-----PD
CASAMBI	CA	per ordinare la versione per smart application CASAMBI aggiungere CA alla fine del codice to order the version for smart application CASAMBI add CA to the end of the code	INC-----CA

versioni Bluetooth per "smart application"; vedi dettagli alle pagine 8 - 9
Bluetooth versions for "smart application"; see details to pages 8 - 9

Kit Emergenza / Emergency Kit

autonomia operation time	tempo di accensione switching time	tempo di ricarica recharging time	foro di incasso minimo (*) minimum recessing hole (*)	IP IP	peso weight	codice code
1 ora / 1 hour	0,5 sec.	24 h.	Ø 75 mm.	IP20	0,43 kg	DRV9092
3 ora / 3 hour	0,5 sec.	24 h.	Ø 100mm.	IP20	0,88 kg	DRV9091

(*) per l'installazione in controsoffitto verificare la compatibilità con il foro di incasso; vedi dettagli a pagina 546
(* for installation in false ceiling check the compatibility with the recessing hole; see details to page 546

Led Panel High Protection IP65

 ^{UP TO} 106lm/W ^{UP TO} UGR < 19 IP65 L80/B20 50.000h. 3 ^{YEARS} WARRANTY

Led Panel High Protection completa la linea Smart con la versione IP65, sia per la parte inferiore che per la parte superiore dell'apparecchio, rendendolo indicato per tutte le installazioni indoor dove è richiesto un elevato grado di impermeabilità e di pulizia dei corpi illuminanti.

Led Panel High Protection completes the Smart line with version IP65, which is suitable for both the lower and upper parts of the unit, making it suitable for all indoor installations where a high degree of waterproofing and clearness of lights is required.





Dimensioni / Dimensions

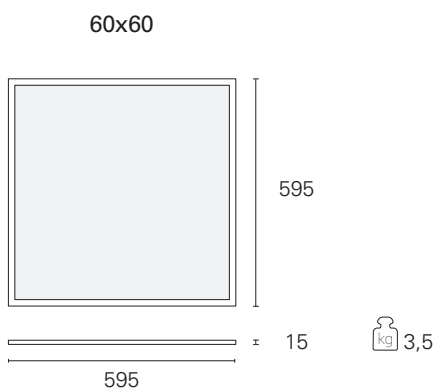

Fast Plug IP65 

Upside and downside IP65 

Driver IP65 

Ottiche / Optics

60x60 - 120° - 4000 K

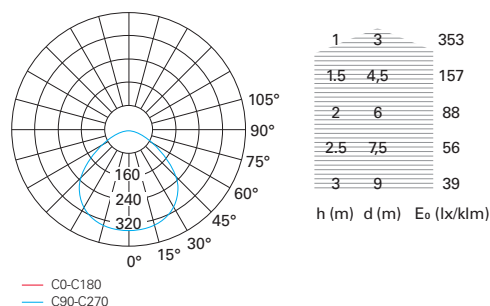

Led Panel High Protection IP65

CRI > 80

dimensioni size	versione version	potenza power	codice code	CCT CCT	flusso apparecchio light output	UGR UGR	ottica optic	colore colour
60x60	On / Off	36 W	INC56442	3000 K	3400 lm	≤ 19	120°	bianco / white
	220 ÷ 240 V		INC56441	4000 K	3850 lm	≤ 19	120°	bianco / white

Led Panel Tunable

☐ 2800÷6500 K ^{UP TO} UGR < 19 L80 / B20 50.000h.   5 YEARS WARRANTY

Led Panel Tunable è in grado di ricreare la ciclicità della luce naturale e illuminare gli ambienti in modo dinamico, gestendo così il variare delle intensità luminose e della temperatura di colore nel tempo per garantire la condizione di massimo comfort visivo e fisiologico delle persone.

Led Panel Tunable is capable of recreating the cyclical nature of natural light and dynamically illuminates the surroundings so that the intensities and colour temperatures vary over time, to ensure maximum visual and physiological comfort for the inhabitants.

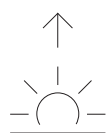

Early morning:
5000 K



Late morning:
4000 K



Afternoon:
6000 K

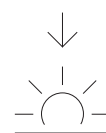

Sunset:
3000 K



Dimensioni / Dimensions

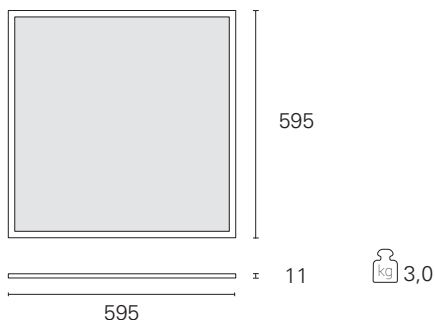

Ottiche / Optics

60x60 - 120° - 4000 K

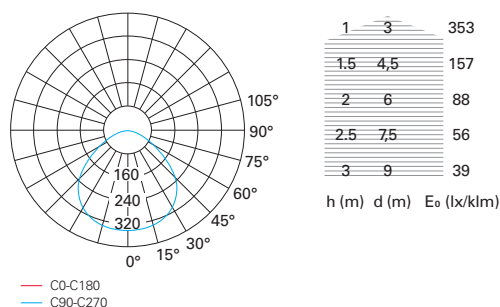

Led Panel Tunable

CRI > 80

dimensioni size	versione version	potenza power	codice code	CCT CCT	flusso apparecchio light output	UGR UGR	ottica optic	colore colour
60x60	DALI 220 ÷ 240 V	36 W	INC56542	2800 K ÷ 6500 K	3300 ÷ 4000 lm	≤ 19	120°	bianco / white

vedi accessori di fissaggio a pg. 38 / see mounting accessories to pg 38.

Versioni dimmerabili / Dimmable versions

con controllo della luce wireless Bluetooth
wireless Bluetooth lighting control





versioni version	suffisso codice code suffix	nota note	esempio example
PAN Digital	PD	per ordinare la versione per smart application PAN Digital aggiungere PD alla fine del codice to order the version for smart application PAN Digital add PD to the end of the code	INC-----PD
CASAMBI	CA	per ordinare la versione per smart application CASAMBI aggiungere CA alla fine del codice to order the version for smart application CASAMBI add CA to the end of the code	INC-----CA

versioni Bluetooth per "smart application"; vedi dettagli alle pagine 8 - 9
Bluetooth versions for "smart application"; see details to pages 8 - 9

Led Panel Accessories

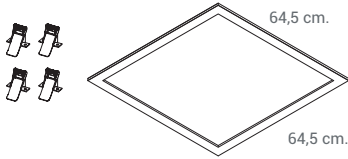
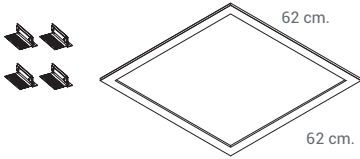
Accessori compatibile solo con Led Panel Smart / Microprismatic / Tunable
Accessories suitable only with Led Panel Smart / Microprismatic / Tunable

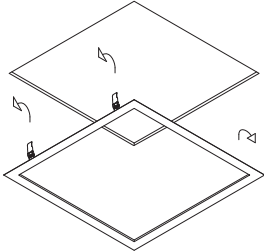
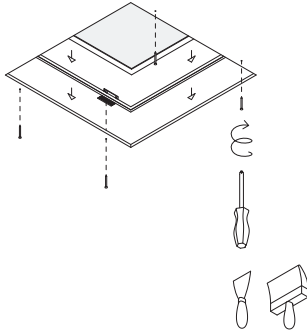
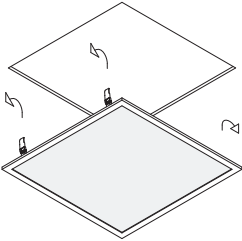

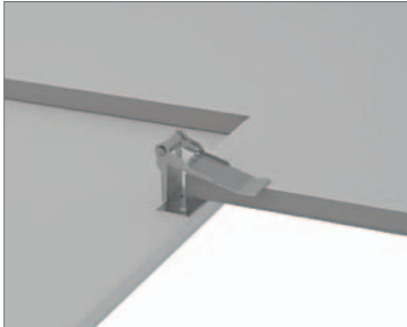
Kit Trimmed Recessed	Kit Trimless Recessed	Kit Semi Recessed <small>Non adatto per LED Panel IP65 / Not suitable for LED Panel IP65</small>	
<p style="text-align: center;">INC1283</p>  <p style="text-align: center;">For 60x60</p>	<p style="text-align: center;">INC1290</p>  <p style="text-align: center;">For 60x60</p>	<p style="text-align: center;">INC1280</p>  <p style="text-align: center;">For 30x30, 30x60, 60x60</p>	<p style="text-align: center;">INC1281</p>  <p style="text-align: center;">For 30x120, 60x120</p>
<p style="text-align: center;">Telaio bianco per installazione ad incasso completo di clips. <i>White frame for recessed panel installation with clips.</i></p> 	<p style="text-align: center;">Telaio bianco per incasso a filo in cartongesso con cornice a scomparsa completo di staffe. <i>White frame for trimless mounting on plasterboard with brackets and retractable frames.</i></p> 	<p style="text-align: center;">Molle per installazione a semincasso su pannello. Telaio non incluso. <i>Springs for recessed panel mounting. Frame not included.</i></p> 	
 <p style="text-align: center;">Spessore cartongesso min. 5 mm. - max. 25 mm. <i>Plasterboard thickness min. 5 mm. - max. 25 mm.</i></p>	 <p style="text-align: center;">Spessore cartongesso min. 9,5 mm. - max. 20 mm. <i>Plasterboard thickness min. 9,5 mm. - max. 20 mm.</i></p>	 <p style="text-align: center;">Spessore cartongesso min. 9,5 mm. - max. 15 mm. <i>Plasterboard thickness min. 9,5 mm. - max. 15 mm.</i></p>	



Kit Ceiling Mounted

Non adatto per LED Panel IP65 / Not suitable for LED Panel IP65

INC1285



INC1286

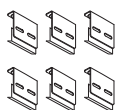

For

30x30, 30x60, 60x60

For

30x120, 60x120

Kit Pendant

Non adatto per LED Panel IP65 / Not suitable for LED Panel IP65

INC1291 INC1291D (*)

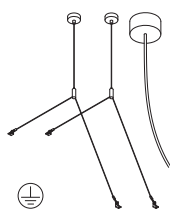

For

30x30, 30x60, 60x60

INC1292 INC1292D (*)

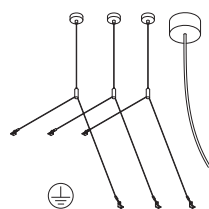

For

30x120, 60x120

(*) Versione DALI / (*) DALI version

Safety cables

Non adatto per LED Panel IP65 / Not suitable for LED Panel IP65

SOS50014

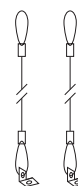

Staffe per installazione a soffitto non regolabile.

Fixed stirrups for ceiling installation.

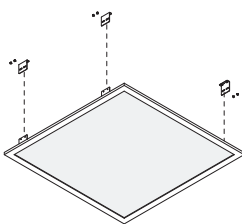

Installazione base a sospensione.

Suspension-based installations.

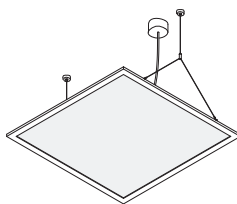

Cavi di sicurezza lunghezza 65 cm.

Safety cables length 65 cm.

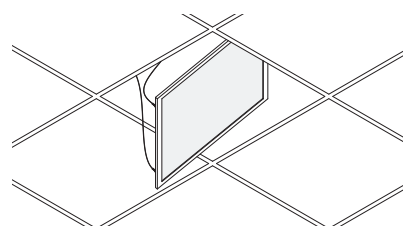

Distanza pannello dal soffitto 40 mm.
Distance from ceiling 40 mm.

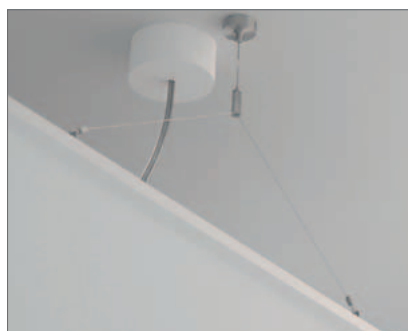

Cavo in acciaio 1200 mm. / Steel cable 1200 mm.
Cavo rosone 3000 mm. / Canopy cable 3000mm

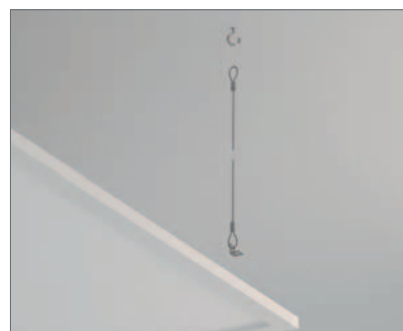

Cavi di sicurezza lunghezza 65 cm.
Safety cables length 65 cm.

Panel Box





Panel Box

I kit Panel Box consentono di installare i pannelli Backlit e i Led Panel a sospensione e a soffitto.

I Panel Box per Led Panel sono installabili anche a parete. I kit comprendono tutti gli elementi di fissaggio e di connessione necessari, sia a 3 poli che a 5 poli per impianti DALI, e vanno completati con la tipologia di pannello desiderata (non incluso). I Panel Box sono disponibili per tutte le misure delle serie Backlit e Led Panel.

Panel Box kit frames are suitable for Backlit and Led Panel, for pendant and ceiling mounting. Panel Box for Panel Led are available also for wall mounting. Panel Box kits are supplied with fixing or suspension elements as well as a 3-pole and 5-pole power cable for DALI systems. They must be completed with the choosen Backlit or Led Panel (not included).



Dimensione dei moduli / *Modules sizing*



30x30



30x60

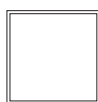

60x60



30x120



60x120



Cavi di sospensione
da 3000 mm.
con sistema di
regolazione fine.

*3000 mm. suspension
cables with
adjustment system.*



Panel Box

per Backlit / *For Backlit*

per Led Panel / *For Led Panel*

High protection IP65

Backlit
Led Panel IP65

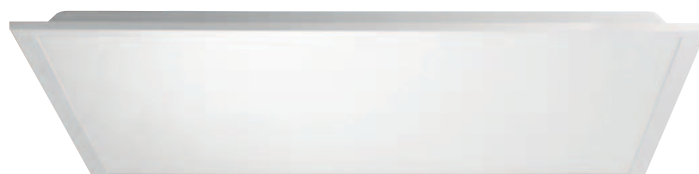

Panel Box



70 mm.

Panel Box Kit

per Backlit e Led Panel IP65 / *for Backlit and Led Panel IP65*

installazione <i>mounting</i>	versione <i>version</i>	dimensioni <i>size</i>	codice <i>code</i>	colore <i>colour</i>
Soffitto <i>Ceiling mounting</i>	kit per Backlit / Led Panel IP65 <i>kit for Backlit / Led Panel IP65</i>	60x60	PLA60122	bianco / <i>white</i>
	On / Off	30x120	PLA60123	bianco / <i>white</i>
	Dimmable (Push - 1...10V - DALI) Digital versions (Pan Digital - Casambi)	60x120	PLA60124	bianco / <i>white</i>
Sospensione <i>Pendant</i>	kit per Backlit / Led Panel IP65 <i>kit for Backlit / Led Panel IP65</i>	60x60	SOS60122	bianco / <i>white</i>
	On / Off	30x120	SOS60123	bianco / <i>white</i>
		60x120	SOS60124	bianco / <i>white</i>
	kit per Backlit / Led Panel IP65 <i>kit for Backlit / Led Panel IP65</i>	60x60	SOS60122D	bianco / <i>white</i>
	On / Off	30x120	SOS60123D	bianco / <i>white</i>
	Dimmable (Push - 1...10V - DALI) Digital versions (Pan Digital - Casambi)	60x120	SOS60124D	bianco / <i>white</i>

I kit Panel Box devono essere completati con il pannello Backlit o Led Panel IP65 prescelto da ordinare separatamente.
I kit per Backlit / Led Panel IP65 non sono idonei per l'installazione a parete.

*The Box Panel kits must be completed with the selected Backlit or Led Panel IP65 to order separately.
Backlit / Led Panel IP65 kits are not suitable for wall-mounting installation.*

Panel Box

per Led Panel / *For Led Panel*

Smart / Microprismatic / Tunable

Led Panel



Panel Box



45 mm.

Panel Box Kit per Led Panel / *Panel Box Kit for Led Panel*

installazione <i>mounting</i>	versione <i>version</i>	dimensioni <i>size</i>	codice <i>code</i>	colore <i>colour</i>
Soffitto / Parete <i>Wall or Ceiling mounting</i>	kit per Led Panel / <i>kit Led Panel</i>	30x30	PLA50120	bianco / <i>white</i>
	On / Off	30x60	PLA50121	bianco / <i>white</i>
	Dimmable (Push - 1...10V - DALI)	60x60	PLA50122	bianco / <i>white</i>
	Digital versions (Pan Digital - Casambi)	30x120	PLA50123	bianco / <i>white</i>
		60x120	PLA50124	bianco / <i>white</i>
		62x62	PLA50125	bianco / <i>white</i>
Sospensione <i>Pendant</i>	kit per Led Panel / <i>kit Led Panel</i> On / Off	30x30	SOS50120	bianco / <i>white</i>
		30x60	SOS50121	bianco / <i>white</i>
		60x60	SOS50122	bianco / <i>white</i>
		30x120	SOS50123	bianco / <i>white</i>
		60x120	SOS50124	bianco / <i>white</i>
		62x62	SOS50125	bianco / <i>white</i>
	kit per Led Panel / <i>kit Led Panel</i> On / Off Dimmable (Push - 1...10V - DALI) Digital versions (Pan Digital - Casambi)	30x30	SOS50120D	bianco / <i>white</i>
		30x60	SOS50121D	bianco / <i>white</i>
		60x60	SOS50122D	bianco / <i>white</i>
		30x120	SOS50123D	bianco / <i>white</i>
		60x120	SOS50124D	bianco / <i>white</i>
		62x62	SOS50125D	bianco / <i>white</i>

I kit Panel Box devono essere completati con il pannello Led Panel prescelto da ordinare separatamente.

The Box Panel kits must be completed with the selected Led Panel to order separately.

Industriali

Industrial Luminaires



Puck Smart
p.52



Puck Plus
p.58



Lane
p.64

Puck Program



Quality

Light control

Ottiche di precisione intercambiabili progettate specificatamente per i led, per gestire ed ottimizzare i fasci luminosi in funzione delle specifiche applicazioni illuminotecniche.

Interchangeable precision optics specifically designed for LEDs, for the management and optimization of the light beams according to the specific lighting applications.

Quality of light

Temperature di colore della luce a 4000 K e 5000 K, resa del colore CRI>80 in linea con i più recenti standard di settore.

Light colour temperature 4000 k and 5000 K, colour rendering CRI> 80 aligned to the latest lighting standard regulations.

UV Free

Solo luce utile. L'emissione selettiva dei led elimina le bande ultraviolette per ottenere massima efficienza energetica e massima qualità della luce emessa.

The selective emission of the LEDs removes the ultraviolet bands to achieve maximum energy efficiency and maximum quality of the light emitted.

Visual Safe

Esente da rischio fotobiologico (RG0)

Free of photo-biological risk (RG0)

Performance

Best efficacy

Elevata performance luminosa ed energetica. Efficacia luminosa fino a 140 lumen/Watt, categoria di risparmio energetico A+.

High luminous and energy performance. Luminous efficiency up to 140 Lm/W, energy saving category A +.

Istant ON / OFF

Accensione e riaccensione a caldo immediata per la massima sicurezza visiva.

Instant switching ON/OFF and re-ignition for maximum safe of the visual conditions.

Ripple free

Luce priva di effetto flicker per il massimo comfort visivo

Light without flicker effects for maximum visual comfort.

Wider operating

Versioni per impianti in ambienti con temperature elevate.

Some versions suitable for lighting environments with high temperature ranges.



Profit

Short Payback

18 mesi di payback
(stima per retrofit di hi bay tradizionali 250W
HID con Puck Smart 100W Led: costo di
riferimento dell'energia 0.15
per kW/h, 4000h di esercizio annue,
lumen output +9%).

*18 months payback
(estimate based on comparison
of example for retrofit of traditional
Hi Bay 250W HID with Puck Smart
100W Led: references energy
unit cost 0.15 per kW/h, 4000h annual running
time, lumen output + 9%).*

No relamping

Led e driver con vita media fino
a 50.000 ore eliminano i tradizionali
costi di relamping.

*LEDs and drivers lifetime up to
50,000 hours sets the traditional
relamping costs to zero.*

Declaration

IK10

Tutti gli apparecchi della linea Industrial sopportano
fino a 20 Joules di impatto (IK10), garantendo così la
massima resistenza meccanica all'urto.

*All lighting fittings of the Industrial Line
can bear the impact up to 20 Joules (IK10),
in order to guarantee maximum mechanical impact
resistance.*

Warranty

Garanzia 3 / 5 anni

Warranty 3 / 5 years

Test compliance

LM 80

TM 21

RoHS

Puck Program

Applicazioni / Applications

Em = 200/300 lux

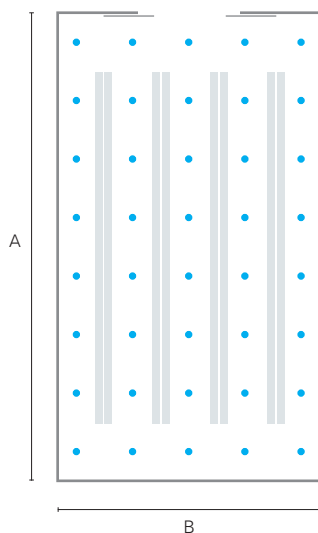

attività <i>activity</i>	es. Preparazioni, Assemblaggio, Magazzini... <i>e.g. Preparation, Assembly, Warehouses...</i>
superficie <i>surface</i>	1400 m ² .
lunghezza <i>length</i>	A = 50 m.
larghezza <i>width</i>	B = 28 m.
ore di esercizio annuale <i>working time</i>	4000 ore circa (12 ore giornaliere per 330 giorni). <i>4000 h (12 h daily 330 days by year).</i>



Generic Hi Bay HIT 250W

Puck Smart Led 100W

	Generic Hi Bay HIT 250W	Puck Smart Led 100W	
potenza / <i>power</i>	250 W	100 W	
flusso sorgente / <i>source flux</i>	22.000 lumen	12.650 lumen	
rendimento ottico / <i>fixture efficacy</i>	0,71	0,95	
flusso apparecchio / <i>fixture lumen output</i>	15.600 lumen	12.000 lumen	
efficacia / <i>efficacy</i>	62 lm/W	120 lm/W	
n° apparecchi / <i>n° fixtures</i>	40	40	
potenza installata / <i>power supplied</i>	10 kW	4 kW	
altezza di installazione 6 metri <i>installation height 6 meters</i>	Ottica / <i>Optic</i>	△ 50°	△ 90°
	Em	275 lux	325 lux
	Emin / Em	0,55	0,56
	UGR	< 25	< 25
altezza di installazione 9 metri <i>installation height 9 meters</i>	Ottica / <i>Optic</i>	△ 50°	△ 60°
	Em	245 lux	345 lux
	Emin / Em	0,54	0,56
	UGR	< 25	< 22

Potenza installata
Power supplied



Efficienza
Efficiency

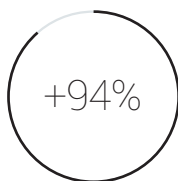

Illuminamento medio
Medium illuminance



Installazione rapida
Fast mounting

No relamping
No relamping

Manutenzione ridotta
Maintenance reduced

Pulizia facilitata
Easy cleaning

(*) Valori stimati con software di simulazione illuminotecnica. / (*) Estimated with lighting calculation software.

Em = 400/500 lux

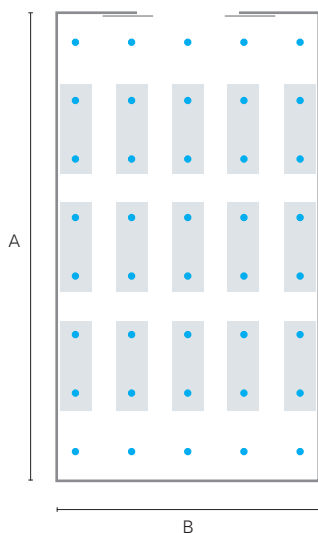

attività
activity
es. Produzioni, Lavorazioni, Finiture...
e.g. Production, Working, Finishing...

superficie
surface
1400 m².

lunghezza
length
A = 50 m.

larghezza
width
B = 28 m.

ore di esercizio annuale
working time
4000 ore circa (12 ore giornaliere per 330 giorni).
4000 h (12 h daily 330 days by year).



Generic Hi Bay HIT 400W

Puck Plus Led 150W

potenza / power	400 W	150 W	
flusso sorgente / source flux	34.000 lumen	21.500 lumen	
rendimento ottico / fixture efficacy	0,71	0,9	
flusso apparecchio / fixture lumen output	24.000 lumen	19.500 lumen	
efficienza / efficacy	60 lm/W	130 lm/W	
n° apparecchi / n° fixtures	40	40	
potenza installata / power supplied	16 kW	6 kW	
	Ottica / Optic 50°	Ottica / Optic 90°	
altezza di installazione 6 metri installation height 6 meters	Em	440 lux	520 lux
	Emin / Em	0,55	0,56
	UGR	< 25	< 25
	Ottica / Optic 50°	Ottica / Optic 60°	
altezza di installazione 9 metri installation height 9 meters	Em	400 lux	500 lux
	Emin / Em	0,54	0,55
	UGR	< 25	< 22

Potenza installata
Power supplied

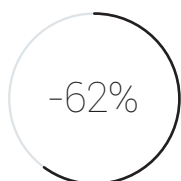

Efficienza
Efficiency

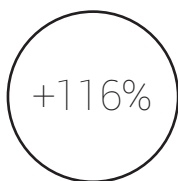

Illuminamento medio
Medium illuminance



Installazione rapida
Fast mounting

No relamping
No relamping

Manutenzione ridotta
Maintenance reduced

Pulizia facilitata
Easy cleaning

(*) Valori stimati con software di simulazione illuminotecnica. / (*) Estimated with lighting calculation software.

Puck Smart



⊕ Pf > 0,95 IP65 IK10 120 lm/W L70/B20 50.000 h. 3 YEARS WARRANTY

Indicata per l'illuminazione indoor dei magazzini e delle aree di produzione, la serie Puck Smart è equipaggiata con sorgenti SMD LED e con lenti ottiche. Corpo in pressofusione di alluminio per l'ottimizzazione della dissipazione termica. Installabile a sospensione con cavo o catena (non inclusi) oppure a soffitto e parete mediante staffa accessoria (da ordinare separatamente). Emissione diretta rotosimmetrica per luce controllata. Schermi ottici in accessorio.

Suitable for indoor lighting of warehouses and production areas, the Puck Smart series is equipped with SMD LED sources and optical lenses. Die-cast aluminum body for the optimization of heat dissipation. Can be installed in suspension with cable or chain (not included) or on the ceiling and wall using an accessory bracket (to be ordered separately). Direct rotationally symmetrical emission for controlled light. Optical screens in accessory.



- Accensioni ON/OFF.
- Alimentazione 220-240 V in Classe "I".
- Fattore di potenza >0.95. Temperatura ambiente di esercizio da -30°C a +45°C.
- Mantenimento del flusso luminoso L70/B20 50.000h. effettivi secondo procedura standard LM-80 e TM-21.
- Emissioni luminose da 12.000/18.000/24.000 lumen.
- Efficacia luminosa 120lm/W.
- Efficienza energetica classe A+.
- Lenti Ottiche da 60° per UGR<22 e da 90° per UGR<25.
- Temperatura di colore dei led 4000 K e 5000 K con resa cromatica CRI>80.
- IK10 / IP65 per applicazioni indoor.
- Schermi in accessorio in policarbonato trasparente e in alluminio finitura silver.
- Protettore dalle sovracorrenti e box di connessione a 4 vie IP65 (accessori non inclusi).
- Light Green, CO2 pollution reduction, No UV. RoHS compliance.
- 3 anni di garanzia.



- *Switching ON / OFF .*
- *220-240 V power supply in Class "I".*
- *Power factor> 0.95. Operating ambient temperature from -30° C to + 45° C.*
- *Maintenance of the luminous flux L70 / B20 50.000h. according to the standard procedure LM-80 and TM-21.*
- *12.000 / 18.000 / 24.000 lumen light emissions.*
- *120lm / W luminous efficacy.*
- *Class A + energy efficiency.*
- *60° Optical Lenses for UGR <22 and 90° for UGR <25.*
- *Colour temperature 4000 K and 5000 K. LEDs, CRI colour rendering> 80.*
- *IK10 / IP65 for indoor applications.*
- *Transparent polycarbonate and silver finish aluminum shade.*
- *Surge Protector and IP65 4-way waterproof junction box series (not included).*
- *Light Green, CO2 pollution reduction, No UV. RoHS compliance.*
- *3 years warranty.*

Puck Smart

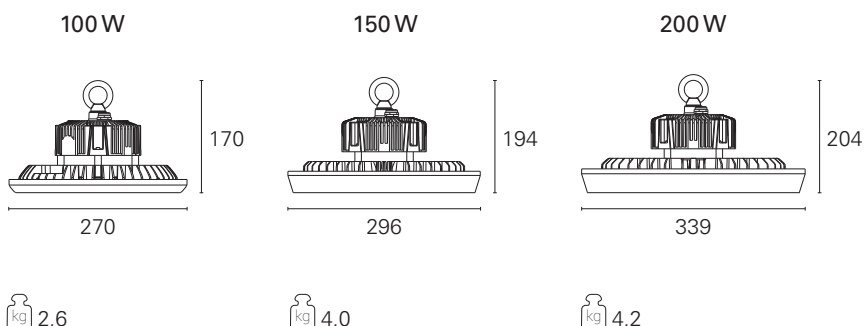
Dimensioni / Dimensions

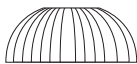
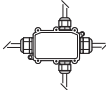

Accessori / Accessories

descrizione description	peso peso	100 W	150 W	200 W
 schermo opaco in alluminio <i>silver aluminium shade</i>	0,378 kg	IND02951	IND02951	IND02952
 schermo PC trasparente <i>transparent PC shade</i>	0,470 kg	IND02954	IND02954	IND02955
 staffa di fissaggio <i>mounting bracket</i>	0,950 kg	IND02910	IND02911	IND02912
 connettore IP65 <i>junction box IP65</i>	0,134 kg	IND02921	IND02921	IND02921
 protettore sovratensione <i>surge protector</i>	0,174 kg	IND02922	IND02922	IND02922

Ottiche / Optics

60° - 5000 K

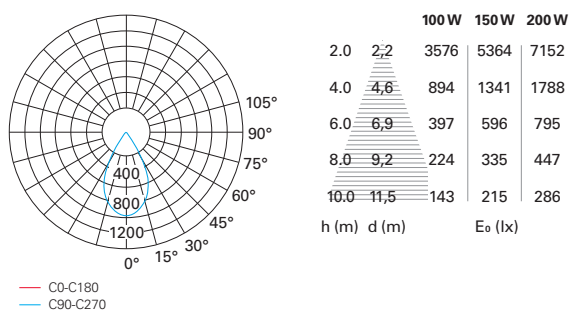

90° - 5000 K

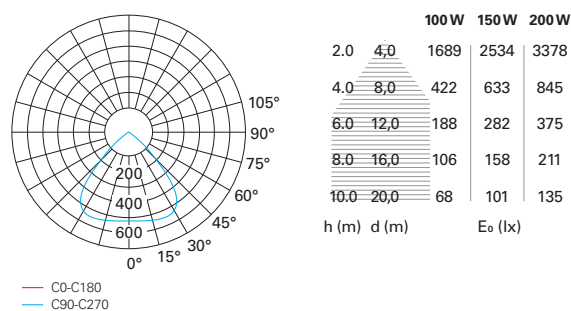

(*) Catena per sospensione non inclusa.

(*) Suspension chain not included.



Puck Smart

versione version	CCT CCT	potenza power	ottica optic	codice code	flusso apparecchio lumen output	CRI CRI	UGR UGR	alimentazione power feed
On / Off 220 ÷ 240 V	4000 K	100 W	60°	IND01007	11450 lm	≥ 80	≤ 22	220-240V
			90°	IND01008	12510 lm	≥ 80	≤ 25	220-240V
		150 W	60°	IND01009	17055 lm	≥ 80	≤ 22	220-240V
			90°	IND01010	17160 lm	≥ 80	≤ 25	220-240V
		200 W	60°	IND01011	22670 lm	≥ 80	≤ 22	220-240V
			90°	IND01012	22845 lm	≥ 80	≤ 25	220-240V
	5000 K	100 W	60°	IND01001	12315 lm	≥ 80	≤ 22	220-240V
			90°	IND01002	13450 lm	≥ 80	≤ 25	220-240V
		150 W	60°	IND01003	18340 lm	≥ 80	≤ 22	220-240V
			90°	IND01004	18450 lm	≥ 80	≤ 25	220-240V
		200 W	60°	IND01005	24375 lm	≥ 80	≤ 22	220-240V
			90°	IND01006	24560 lm	≥ 80	≤ 25	220-240V





Puck Plus



⊕ Pf > 0,95 IP65 IK10 130 lm/W L70/B20 50.000 h. 5 YEARS WARRANTY

Indicata per l'illuminazione indoor dei magazzini e delle aree di produzione, la serie Puck Plus si avvale di componentistica led e driver selezionati dai migliori produttori di elettronica (selezione prime label). Equipaggiata con SMD LED e lenti ottiche. Versioni ON/OFF, dimmerabili 1...10V, DALI. Corpo in pressofusione di alluminio per ottimizzazione della dissipazione termica. Installabile a sospensione con cavo o catena (non inclusi) oppure a soffitto e parete mediante staffa accessoria (da ordinare separatamente). Emissione diretta rotosimmetrica per luce controllata. Schermi ottici in accessorio. Sensore di presenza per versioni dimmerabili (accessorio non incluso)

Suitable for lighting of indoor warehouses and production areas, Puck Plus is equipped with LEDs and DRIVER first label selection. Equipped with SMD LED and optical lenses. Versions available ON / OFF, dimmable 1 ... 10V, DALI. Die-cast aluminum body for optimization of heat dissipation. Suitable for ceiling or wall mounting using a brackets kit (to be ordered separately) or for suspension mounting using chains (not included). Rotosymmetric direct emission for controlled light. Optical shades as accessory. Microwave motion sensor for dimmable versions (accessory not included).



- Accensioni ON/OFF, Dimm 1...10V, DALI.
- Alimentazione 220-240 V, Classe "I".
- Fattore di potenza >0.95. Temperatura ambiente di esercizio da -30°C a +45°C.
- Mantenimento del flusso luminoso L70/B20 50.000h. effettivi secondo procedura standard LM-80 e TM-21.
- Emissioni luminose da 13.000 / 19.500 / 26.000 lumen.
- Efficacia luminosa 130lm/W.
- Efficienza energetica classe A+.
- Lenti Ottiche da 60° per UGR<22 e da 90° per UGR<25.
- Temperatura di colore dei led 5000K con resa cromatica CRI>80. Versioni a 4000 K su richiesta.
- IK10 / IP65 per applicazioni indoor.
- Schermi in accessorio in policarbonato trasparente e in alluminio finitura silver.
- Protettore dalle sovracorrenti e box di connessione a 4 vie IP65 accessori (non inclusi).
- Sensore di presenza/movimento accessorio non incluso (solo per versioni dimmerabili).
- Light Green, CO2 pollution reduction, No UV. RoHS compliance.
- 5 anni di garanzia.



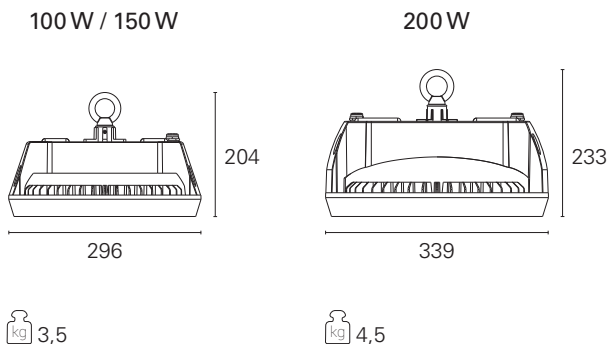

- *ON / OFF, Dimmable 1 ... 10V, DALI.*
- *220-240 V power supply, Class "I".*
- *Power factor > 0.95. Operating temperature from -30° C to + 45° C.*
- *Maintenance of the luminous flux L70 / B20 50.000h. according to the standard procedure LM-80 and TM-21.*
- *Light emissions from 13.000 / 19.500 / 26.000 lumens.*
- *130 lm/W luminous efficacy.*
- *Class A + energy efficiency.*
- *60° Optical Lenses for UGR <22 and 90° for UGR <25.*
- *Colour temperature 5000K leds, CRI > 80. 4000 K versions available bespoke.*
- *IK10 / IP65 for indoor applications.*
- *Transparent polycarbonate and silver finishing aluminum shade (accessory).*
- *Surge protector and 4-way waterproof junction box IP65 not included.*
- *Microwave motion sensor accessory not included (only for dimmable versions).*
- *Light Green, CO2 pollution reduction, No UV. RoHS compliance.*
- *5 years warranty.*

Puck Plus

Dimensioni / Dimensions

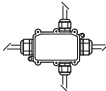

Accessori / Accessories

	descrizione description	peso peso	100 W	150 W	200 W
	schermo opaco in alluminio silver aluminium shade	0,378 kg	IND02951	IND02951	IND02952
	schermo PC trasparente transparent PC shade	0,470 kg	IND02954	IND02954	IND02955
	staffa di fissaggio mounting bracket	0,950 kg	IND02911	IND02911	IND02912
	senso di presenza motion sensor	0,368kg	IND02931	\	\
	connettore IP65 junction box IP65	0,134 kg	IND02921	IND02921	IND02921
	protettore sovratensione surge protector	0,174 kg	IND02922	IND02922	IND02922

Ottiche / Optics

60° - 5000 K

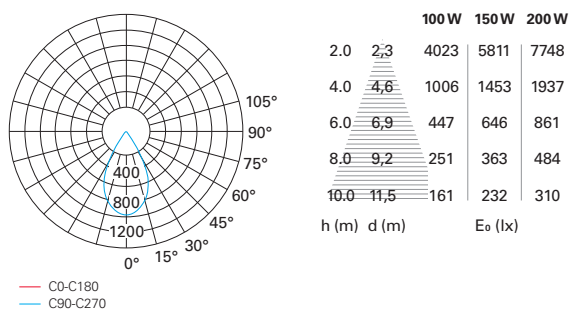

90° - 5000 K

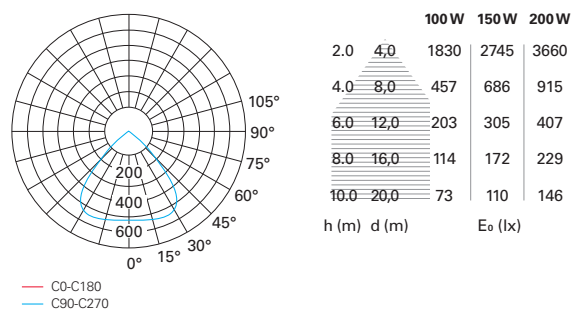

(*) Catena per sospensione non inclusa.

(*) Suspension chain not included.



Puck Plus

versione version	CCT CCT	potenza power	ottica optic	codice code	flusso apparecchio lumen output	CRI CRI	UGR UGR	alimentazione power feed
On / Off 220 ÷ 240 V	5000 K	100 W	60°	IND02001	14375 lm	≥ 80	≤ 22	220-240V
			90°	IND02002	14440 lm	≥ 80	≤ 25	220-240V
		150 W	60°	IND02003	21270 lm	≥ 80	≤ 22	220-240V
			90°	IND02004	21400 lm	≥ 80	≤ 25	220-240V
		200 W	60°	IND02005	28425 lm	≥ 80	≤ 22	220-240V
			90°	IND02006	28645 lm	≥ 80	≤ 25	220-240V
Dimm 1...10 V 220 ÷ 240 V	5000 K	100 W	60°	IND02001D	14375 lm	≥ 80	≤ 22	220-240V
			90°	IND02002D	14440 lm	≥ 80	≤ 25	220-240V
		150 W	60°	IND02003D	21270 lm	≥ 80	≤ 22	220-240V
			90°	IND02004D	21400 lm	≥ 80	≤ 25	220-240V
		200 W	60°	IND02005D	28425 lm	≥ 80	≤ 22	220-240V
			90°	IND02006D	28645 lm	≥ 80	≤ 25	220-240V
DALI 220 ÷ 240 V	5000 K	100 W	60°	IND02001DA	14375 lm	≥ 80	≤ 22	220-240V
			90°	IND02002DA	14440 lm	≥ 80	≤ 25	220-240V
		150 W	60°	IND02003DA	21270 lm	≥ 80	≤ 22	220-240V
			90°	IND02004DA	21400 lm	≥ 80	≤ 25	220-240V
		200 W	60°	IND02005DA	28425 lm	≥ 80	≤ 22	220-240V
			90°	IND02006DA	28645 lm	≥ 80	≤ 25	220-240V

Versioni a 4000 K su richiesta
4000 K versions available bespoke

Puck Program

Accessori / *Accessories*

Schermi / *Shade*

Schermo opaco in alluminio
Silver Aluminium Shade

Schermo PC trasparente
Transparent PC Shade

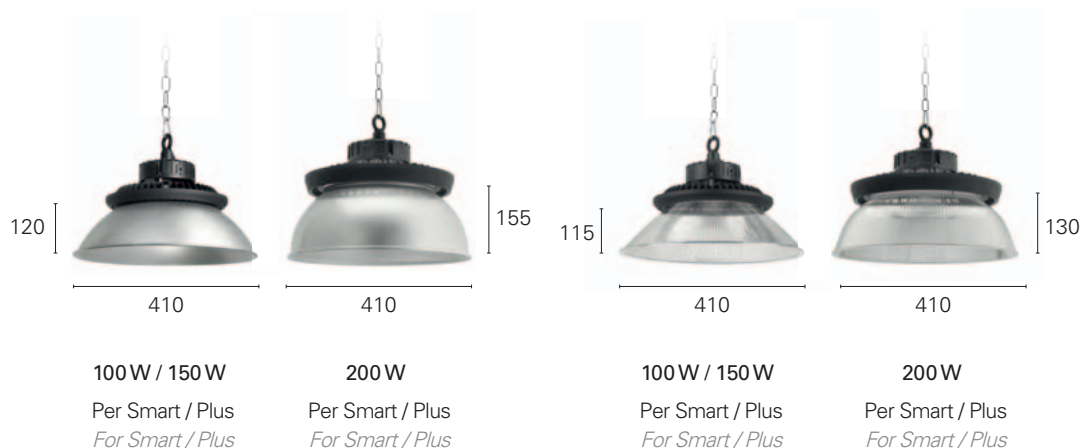

Elettronica / *Electric*

Sensore di presenza
Motion Sensor

Connettore IP65
Junction Box IP65

Protettore sovratensione
Surge Protector



Per Plus Dimm 1...10V
For Plus Dimm 1...10V

Montaggio / *Mounting*

Staffa di fissaggio
Mounting Bracket



(*) Catena per sospensione non inclusa. / (*) Suspension chain not included.

Sensore di movimento / *Motion sensor*

A completamento delle versioni dimmerabili della serie Puck, il sensore di movimento permette di rilevare la presenza di persone in attività all'interno degli ambienti. Ideale per le aree dove il passaggio di persone è ridotto, ottimizza i consumi elettrici gestendo automaticamente l'accensione e la dimmerazione degli apparecchi e fornisce la luce strettamente necessaria all'attività che si sta svolgendo.

As accessory for dimmable version of Puck Series, the Motion Sensor detects the presence of activities inside the rooms and the ambients. Ideal where the passage of people is rare, the Motion Sensor optimizes the energy consumption thanks to a presetted automatic dimming of the fixtures, then providing the light strictly necessary for working activities at the right time.

Setting / *Settings*

Setup / <i>Setup</i>	Presenza attiva / <i>Active presence</i>	Stand by / <i>Stand by</i>
Primi settaggi in funzione delle caratteristiche dell'ambiente <i>First settings according to the features of the environment</i>	Presenza di attività e movimento nell'area di rilevamento <i>Presence of activity and movement in the area of sensitivity</i>	Al termine dell'attività il sensore entra in stand by prima di disattivarsi completamente <i>At the end of the activity, the sensor comes into standby before turning off completely</i>
Altezza di installazione massima <i>Maximum installation height</i> 15 m	Movimento rilevato <i>Motion delection</i> 0,5 ÷ 3 m/sec	Livello di output in Stand by <i>Stand by output level</i> 50% / 30% / 20% / 10%
Area di rilevamento <i>Delection area</i> 50% (Ø 4 m) / 100% (Ø 8 m)	Livello di output operativo <i>Working output level</i> 100%	Tempo di Stand by <i>Stand by period</i> ∞ / 60 min / 30 min 10 min / 5 min / 5 sec
Soglia di sensibilità luce ambiente <i>Daylight sensor</i> Disable / 200 / 100 / 50 lux	Tempo di mantenimento <i>Hold time</i> 5 sec / 30 sec / 90 sec 3 min / 20 min / 30 min	

Area di rilevamento / *Detection area*

Montaggio a soffitto
Ceiling mounting pattern

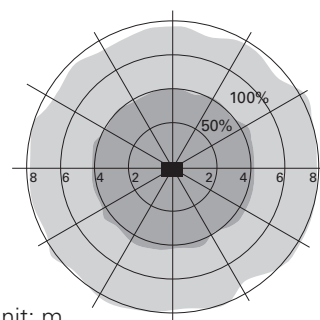

Lane



⊕ Pf > 0,92 IP65 IK10 130 lm/W L70/B20 50.000 h. 5 YEARS WARRANTY

Indicata per l'illuminazione indoor delle aree di produzione in linea e delle corsie di stoccaggio. Componentistica led e driver di prima scelta (selezione prime label). Equipaggiata con SMD led e lenti ottiche. Corpo in estrusione di alluminio per ottimizzazione della dissipazione termica. Installabile a soffitto o a parete mediante kit di staffe (include) oppure a sospensione mediante catene (non include). Emissione diretta simmetrica, asimmetrica o ellittica.

These products are specifically suitable for the lighting of in line indoor production areas and storage lanes. LEDs and DRIVER first label selection. Equipped with SMD LEDs and optical lenses. Body in extruded aluminum for optimization of heat dissipation. Suitable for ceiling or wall mounting using a brackets kit (included) or for suspension mounting using chains (not included). Direct symmetric, asymmetric or elliptical emission.



- Accensione ON/OFF.
- Alimentazione 220-240 V, Classe "I".
- Fattore di potenza >0.92. Temperatura ambiente di esercizio da -30°C a +45°C.
- Mantenimento del flusso luminoso L70/B20 50.000h. effettive secondo procedura standard LM-80 e TM-21.
- Emissioni luminose da 13.000/19.500 lumen.
- Efficienza luminosa 130 lm/W.
- Efficienza energetica A+.
- Lenti ottiche per emissioni rosimmetriche 60° UGR<22, 90° UGR<25, emissione ellittica C0-C180 = 65° e C90-C270 = 30° UGR<22, emissione asimmetrica C90 = 50°, C270 = 20° e C0-C180 = 130°.
- Temperatura di colore dei led 5000K con resa cromatica CRI>80. Versioni a 4000 K su richiesta.
- IK10 / IP66 per applicazioni in interni.
- Protettore dalle sovracorrenti e box di connessione a 4 vie IP65 accessori (non inclusi).
- Light Green, CO2 pollution reduction, no UV, RoHS compliance.
- 5 anni di garanzia.

- *ON / OFF switch-on.*
- *220-240 V power supply, Class "I".*
- *Power factor > 0.92. Operating ambient temperature from -30° C to + 45° C.*
- *Maintenance of the luminous flux L70 / B20 50.000h. according to the standard procedure LM-80 and TM-21.*
- *13.000 / 19.500 lumens light emissions.*
- *130 lm/W luminous efficiency.*
- *Energy efficiency A +.*
- *Optic lens for rosymmetrical emissions 60° UGR<22, 90° UGR<25, elliptical emission C0-C180 = 65°, C90-C270 = 30° UGR<22, asymmetric emission C90 = 50°, C270 = 20° and C0-C180 = 130°.*
- *Colour temperature of 5000K LEDs with CRI > 800. 4000 K versions available bespoke*
- *IK10 / IP66 for indoor applications.*
- *Surge protector and 4-way waterproof junction box IP65 not included.*
- *Light Green, CO2 pollution reduction, no UV, RoHS compliance.*
- *5 years warranty.*

Lane

Applicazione / Application

Em = 400/500 lux

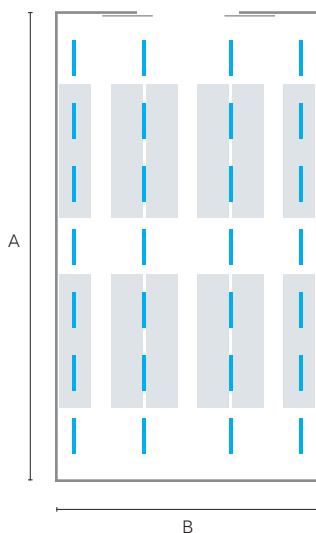

attività
activity

superficie
surface

lunghezza
length

larghezza
width

ore di esercizio annuale
working time

es. Produzione...
e.g. Production...

900 m².

A = 30 m.

B = 30 m.

4000 ore circa (12 ore giornaliere per 330 giorni).
4000 h (12 h daily 330 days by year).



Generic Hi Bay HIT 250W

Lane 100W

potenza / power	250W	150W	
flusso sorgente / source flux	22000 lm	20500 lm	
rendimento ottico / fixture efficacy	0,71	0,95	
flusso apparecchio / fixture lumen output	15620 lm	19500 lm	
efficienza / efficacy	62 lm/W	130 lm/W	
n° apparecchi / n° fixtures	20	20	
potenza installata / power supplied	5 kW	3 kW	
altezza di installazione 7 metri installation height 7 meters	Ottica / Optic	△ 50°	△ 90°
	Em	275 lux	500 lux
	Emin / Em	0,55	0,75
	UGR	< 25	< 25
altezza di installazione 9 metri installation height 9 meters	Ottica / Optic	△ 50°	△ 60°
	Em	225 lux	460 lux
	Emin / Em	0,67	0,71
	UGR	< 25	< 22

Potenza installata
Power supplied



Efficienza
Efficiency

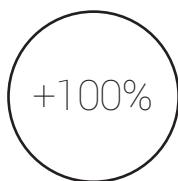

Illuminamento medio
Medium illuminance



Installazione rapida
Fast mounting

No relamping
No relamping

Manutenzione ridotta
Maintenance reduced

Pulizia facilitata
Easy cleaning

(*) Valori stimati con software di simulazione illuminotecnica. (*) Estimated with lighting calculation software.

Symmetric 60°

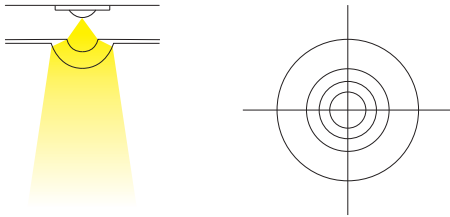

Le ottiche da 60° emettono luce in modo rotosimmetrico e sono ottimali per l'illuminazione da 8÷12 m. di metri di altezza.

60° optics emit rotosymmetric light and are ideal for the lighting of 8÷12 m. height areas.

Symmetric 90°

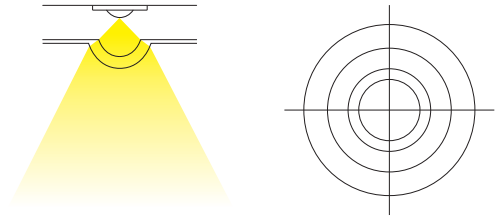

Le ottiche da 90° emettono luce in modo rotosimmetrico e sono ottimali per l'illuminazione da 5÷9 m. di metri di altezza.

90° optics emit rotosymmetric light and are ideal for the lighting of 5÷9 m. height areas.

Asymmetric

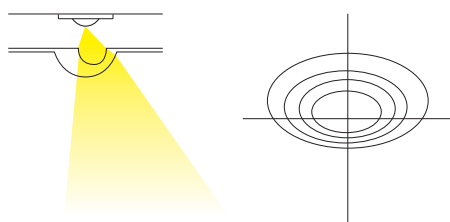

Le ottiche Asymmetric emettono luce prevalentemente di lato e sono indicate per l'illuminazione dei piani verticali come ad esempio gli scaffali di un magazzino o le pareti dei camminamenti.

Asymmetric optics emit light mainly by side and are indicated for the lighting of vertical surfaces such as warehouse's shelves or walkways' walls.

Elliptical

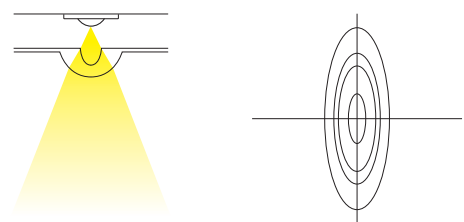

Le ottiche Elliptical forniscono un'emissione allungata della luce per favorire l'illuminazione dei percorsi oppure degli ambienti con punti luce particolarmente distanti.

Elliptical optics emit elongated light to facilitate paths lighting or areas with particularly distant points of light.

Lane

Dimensioni / Dimensions

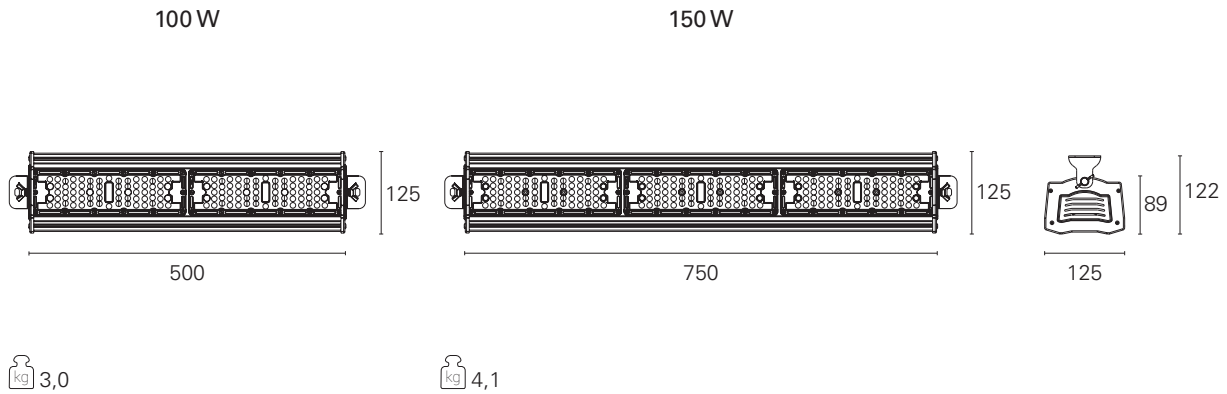

Ottiche / Optics

60° - 5000 K

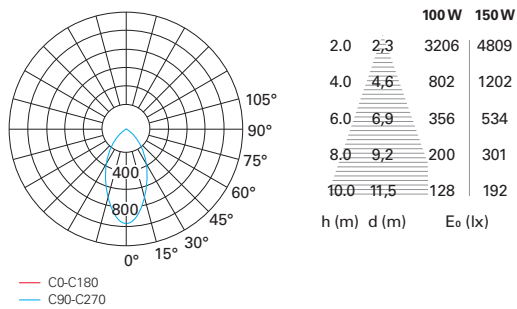

90° - 5000 K

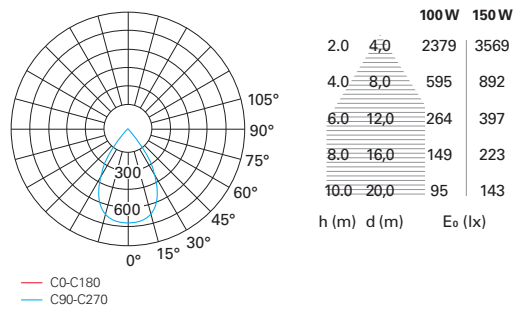

elliptical - 5000 K

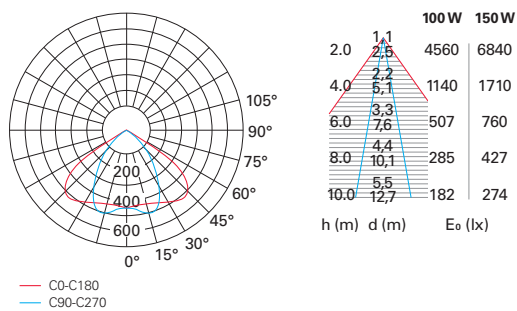

asymmetric - 5000 K

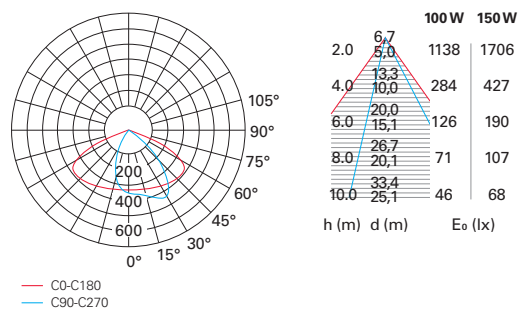

(*) Catena per sospensione non inclusa.
 (*) Suspension chain not included.



Lane

versione version	CCT CCT	potenza power	ottica optic	codice code	flusso apparecchio lumen output	CRI CRI	UGR UGR	alimentazione power feed	
On / Off 220 ÷ 240 V	5000 K	100 W	60°	IND05001	14120 lm	≥ 80	≤ 22	220-240V	
			90°	IND05002	14100 lm	≥ 80	≤ 25	220-240V	
			Elliptical	IND05003	14280 lm	≥ 80	≤ 22 / ≤ 25	220-240V	
			Asymmetric	IND05004	14250 lm	≥ 80	-	220-240V	
	150 W			60°	IND05005	21110 lm	≥ 80	≤ 22	220-240V
				90°	IND05006	21055 lm	≥ 80	≤ 25	220-240V
				Elliptical	IND05007	21440 lm	≥ 80	≤ 22 / ≤ 25	220-240V
				Asymmetric	IND05008	21320 lm	≥ 80	-	220-240V

Versioni a 4000 K su richiesta
 4000 K versions available bespoke

Stripled e Profili

Stripled and Profiles



Mini

p.76



CoB Line

p.78



Light Line

p.80



Light Line Waterproof

p.84



High Efficiency

p.86



Color Quality

p.88



Tunable

p.92



RGB - RGB+W

p.94

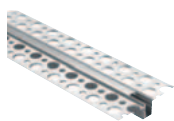

Da Incasso Trimless

p.106



Da Incasso Trimmed

p.111



Da Superficie

p.116

Stripled

Le Stripled sono indicate per l'illuminazione in interni e in esterni e permettono di ricreare effetti di luce lineare per evidenziare percorsi, bordi, volumi e nicchie. Sono equipaggiate con led ad alta efficienza dalle ridotte dimensioni e sono tagliabili secondo la circuitazione lungo le predisposizioni indicate. Con un ampio range di potenze e di emissioni luminose, l'efficacia luminosa raggiunge i 125 lm/W con CRI > 90. Sono alimentate a 24V e realizzate nelle configurazioni IP20, IP65, IP66 e IP67, Tunable, RGB ed RGB+W.

Stripled are suitable for indoor and outdoor lighting and help to achieve linear light effects to highlight paths, edges, volumes and niches. They are equipped with high-efficiency LEDs with reduced dimensions and can be cut, according to the circuit, as indicated. With a wide range of powers and light emissions, the luminous efficacy reaches 100 lm / W with CRI > 90. They are powered at 24V available in IP20, IP65, IP66 and IP67, Tunable, RGB and RGB+W protocols.





Stripled Monocromatiche

Stripled Monochromatic

La costante innovazione tecnologica offre al mercato una gamma di prodotti estremamente efficienti ed in linea con la più aggiornata produzione industriale in ambito Stripled. I nostri fornitori, accuratamente selezionati, garantiscono il costante miglioramento e mantenimento dei più alti standard qualitativi e d'efficienza. Siamo particolarmente sensibili alla tecnologia ed alla ricerca, all'attento controllo del processo di produzione nonché le più ampie garanzie sull'intera filiera produttiva. Il rispetto di queste regole ci ha permesso di raccogliere validi successi commerciali e presentare una rinnovata gamma di strip led allineate alle ultime novità in questa speciale sezione di mercato.

Constant technological innovation allows us to offer an extremely efficient product range in line with the most up-to-date industrial production in the field of LED Strips. Our carefully selected suppliers guarantee constant improvement and maintenance of the highest quality and efficiency standards. We are particularly sensitive to technology and research, we carefully follow the production process with particular attention to the entire production chain. The full respect of these rules has allowed us to obtain real commercial success and to launch a renewed range of LED strips aligned with the latest innovations in this special market section.

5 YEARS
WARRANTY*

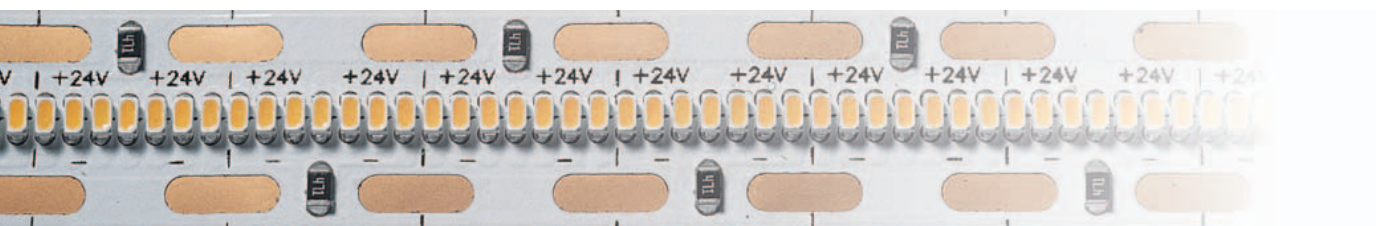

(*) La garanzia è valida solo se la Stripled è installata su superficie alluminio idonea a garantire la corretta dissipazione del calore.
(*) Warranty is valid only if the Stripled are mounted on an aluminium heat-dissipating surface.



“Quality first” IPC-A-610

I nostri prodotti attraversano diverse fasi prima della messa in commercio. Si effettuano test funzionali a temperature differenziate (-40*/+65*), test sulla presenza di umidità, cicli di accensione e spegnimento, di resistenza sulla circuitazione (Twist & bending Test), controllo sui falsi contatti e sulla resistenza all'invecchiamento (aging test), controllo sulla resistenza all'acqua (grado IP). Tutti questi processi sono indicati e registrati dal ciclo produttivo e disponibili per controllo finale. L'assemblaggio elettronico avviene in accordo all'IPC-A610E standard (Idoneità degli assemblaggi elettronici sulla base dello standard IPC ampiamente utilizzato IPC-A-610).

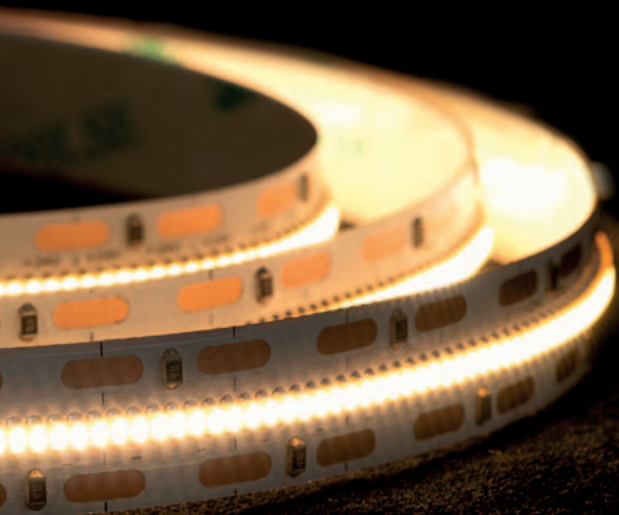

*Our products go through different phases before being put on the market. Functional tests are carried out at different temperatures (-40 * / + 65 *) such as humidity tests , on/off cycles tests, twist & bending tests, false contact tests, aging tests and IP degree tests. All these test results are indicated and recorded by the production process and available for final inspection. Electronic assembly is carried out in accordance with IPC-A610E standard regulations.*

Mini Striped

◆ 24 V DC ^{UP TO} 88 lm/W PCB 4 mm. CRI > 90 5^{ROLL}m. **3M** 5 YEARS WARRANTY

La costante crescita tecnologica propone continuamente nuove soluzioni utili nella progettazione illuminotecnica. LED di dimensioni minimali trovano spazio su un PCB di ridotte dimensioni e nasce una strip ad altissime prestazioni ma con ingombri complessivi estremamente ridotti. L'ideale abbinamento è con i profili della serie Micro, che si contraddistinguono dalle dimensioni estremamente ridotte per installazioni minimali e performanti.

The constant technological growth continuously offers new useful solutions in lighting design. LEDs with minimal dimensions find space on a small PCB and a very high performances make a strip with extremely reduced overall dimensions. The ideal combination is with the Micro series profiles, which are characterized by extremely small dimensions for minimal and high-performance installations.

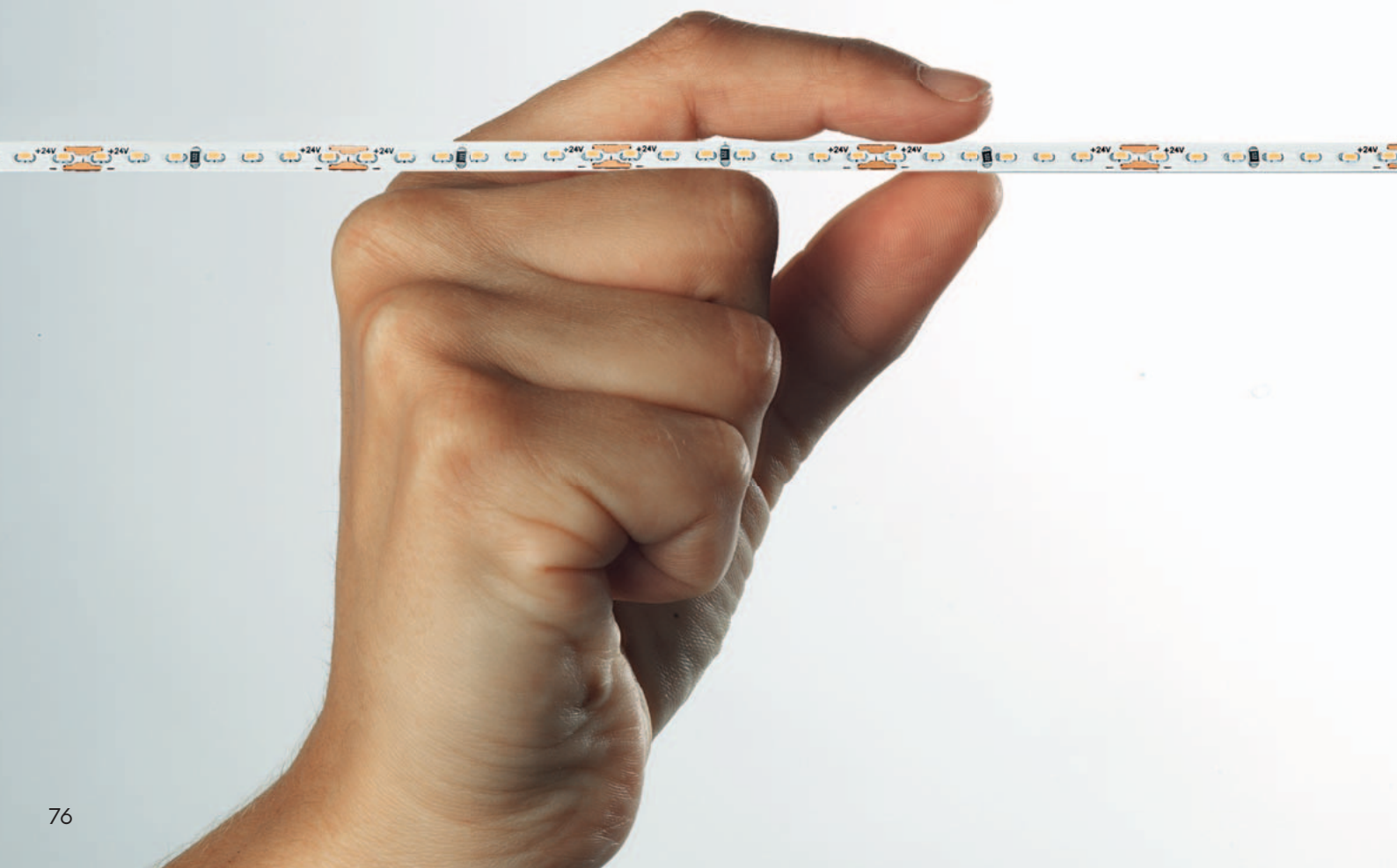

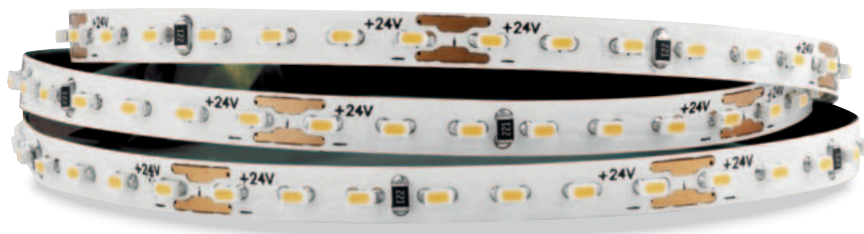

Mini Striped 24V DC

dimensione size	potenza power	codice code	CCT CCT	lm/m. lm/m.	lm/W. lm/W.	modello LED LED model
4 mm.	14,4W/m 196 LED/m	STP10004	2700 K	1166	81	2110
		STP10005	3000 K	1195	83	2110
		STP10006	4000 K	1267	88	2110

CRI > 90 - IP 20



Profili Micro / Micro profiles

MICRO

da incasso trimless
trimless recessed

da incasso trimmed
trimmed recessed

da superficie
surface mounted

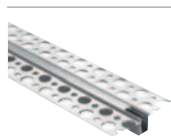

PRO2001
pg. 106



PRO2040
pg. 108



PRO2050
pg. 108



PRO2020
PRO2021
PRO2022
pg. 111



PRO2010
PRO2011
PRO2012
pg. 116

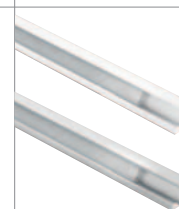

PRO2030
PRO2031
pg. 120

(*) La garanzia è valida solo se la Striped è installata su superficie alluminio idonea a garantire la corretta dissipazione del calore.

(*) Warranty is valid only if the Striped are mounted on an aluminium heat-dissipating surface.

CoB Line Striped

◆ 24 V DC ^{UP TO} 91 lm / W PCB 4/8 mm. CRI > 90 5^{ROLL}m. **3M** 3 YEARS WARRANTY

Le striped della serie CoB Line risolvono definitivamente la problematica dovuta alla puntinatura luminosa che risulta percepibile in molte ministrip tradizionali a causa della vicinanza fra lo schermo e la strip stessa. L'effetto dato dalle CoB Line è quello di una linea continua di luce, senza alcuna interruzione. Le versioni con sezione da 4 mm. sono perfettamente compatibili con i profili in alluminio della serie Micro; questo abbinamento permette di realizzare linee di luce sottilissime, performanti e senza interruzioni di luce. L'utilizzo è particolarmente semplificato anche per il taglio a misura. Le indicazioni riportate sul PCB facilitano le operazioni di messa in opera.

the CoB Line striped definitively solve the light dotting trouble which is perceivable in many traditional ministrips due to the proximity between the screen and the strip itself. The effect given by the CoB Lines is a continuous line of light, without any interruption. The 4 mm models are perfectly suitable with the aluminum profiles of the Micro series; this combination allows to create very thin lines of light, performing and without interruptions of light. The use is also particularly simplified for custom cutting. The indications on the PCB make easier the installation operations.



L'elevata resa cromatica CRI > 90 e il loro PCB di spessore maggiorato che migliora la dissipazione del calore completano le ottime caratteristiche prestazionali di queste innovative stripled. Questi modelli vengono sottoposti a specifici controlli di qualità che includono prove elettriche e funzionali nonché twisting e bending test prima della consegna.

The high color rendering CRI > 90 and their increased thickness PCB which improves heat dissipation complete the excellent performing characteristics of these innovative stripled.

These models are tested under a specific quality control procedure which includes electrical and functional tests as well as twisting and bending tests before delivery.



CoB Line - Striped 24V DC

dimensione size	potenza power	codice code	CCT CCT	lm/m. lm/m.	lm/W. lm/W.	modello LED LED model
4 mm.	8 W/m	STP30101	2700 K	664	83	CoB linear
		STP30102	3000 K	680	85	CoB linear
		STP30103	4000 K	728	91	CoB linear

CRI > 90 - IP 20

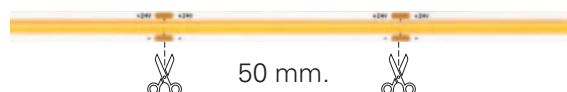

Profili Micro / Micro profiles

da incasso trimless
trimless recessed

da incasso trimmed
trimmed recessed

da superficie
surface mounted



PRO2001
pg. 106



PRO2040
pg. 108



PRO2050
pg. 108



PRO2020
PRO2021
PRO2022
pg. 111



PRO2010
PRO2011
PRO2012
pg. 116

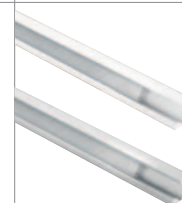

PRO2030
PRO2031
pg. 120

MICRO

(*) La garanzia è valida solo se la Striped è installata su superficie alluminio idonea a garantire la corretta dissipazione del calore.
(*) Warranty is valid only if the Striped are mounted on an aluminium heat-dissipating surface.

CoB Line - Striped 24V DC

dimensione size	potenza power	codice code	CCT CCT	lm/m. lm/m.	lm/W. lm/W.	modello LED LED model
8 mm.	10 W/m	STP30151	2700 K	996	83	CoB linear
		STP30152	3000 K	1020	85	CoB linear
		STP30153	4000 K	1092	91	CoB linear

CRI > 90 - IP 20

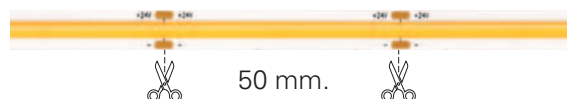

Light Line Striped

◆ 24 V DC ^{UP TO} 100lm / W PCB8/10/12 mm. CRI > 90 5^{ROLL}m. **3M** 5 YEARS WARRANTY

Grazie ai LED 2110 di ultima generazione, caratterizzati dalle altissime efficienze e dagli ingombri ridottissimi, la serie Light Line permette di ottenere linee di luce ideali per evitare la tipica puntinatura dei diodi durante il funzionamento del sistema luminoso. Con un package compatto e solido e con punti di saldatura rinforzati dati dalle linee di montaggio di ultima generazione, Striped Light Line restituisce potenza, efficienza, qualità cromatica di alto livello, affidabilità e perfetta dissipazione per un impiego altamente professionale. La massima espressione tecnologica la troviamo nel modello 700 LED/m. Un vero e proprio concentrato tecnologico da utilizzare nelle situazioni ove si richieda perfetta continuità e totale assenza di ombre sull'intera strip.

Thanks to the latest generation 2110 LEDs, characterized by extremely high efficiency and very small dimensions, the Light Line series allows you to obtain ideal light lines to avoid the typical dotting diodes during operation of the light system. With a compact and solid package and with reinforced welding points provided by the latest generation assembly lines, Striped Light Line returns power, efficiency, high level color quality, reliability and perfect dissipation for highly professional use. The maximum technological expression is found in the 700 LED / m model. A real technological concentrate to be used in situations where perfect continuity and total absence of shadows are required on the entire strip.



Light Line

Striped 24V DC

dimensione size	potenza power	codice code	CCT CCT	lm/m. lm/m.	lm/W. lm/W.	modello LED LED model
8 mm.	4,8 W/m 60 LED/m	STP20101	2700 K	332	83	2216
		STP20102	3000 K	344	86	2216
		STP20103	4000 K	352	88	2216

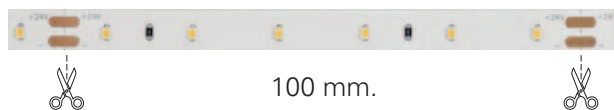

9,6 W/m 140 LED/m	STP20149	2200 K	585	61	2110
	STP20150	2500 K	624	65	2110
	STP20151	2700 K	816	85	2110
	STP20152	3000 K	835	87	2110
	STP20153	4000 K	922	96	2110

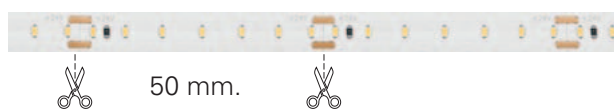

10 mm.	14,4 W/m 180 LED/m	STP20199	2200 K	878	61	2216
		STP20200	2500 K	936	65	2216
		STP20201	2700 K	950	65	2216
		STP20202	3000 K	1020	71	2216
		STP20203	4000 K	1152	80	2216

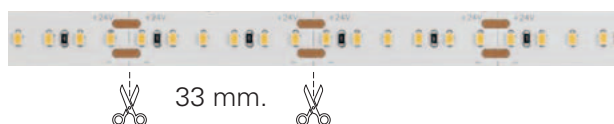

19,2 W/m 238 LED/m	STP20301	2700 K	1747	91	2216
	STP20302	3000 K	1824	95	2216
	STP20303	4000 K	1920	100	2216



19,2 W/m 280 LED/m	STP10025	2700 K	1555	81	2110
	STP10026	3000 K	1594	83	2110
	STP10027	4000 K	1766	92	2110

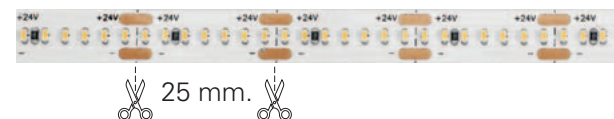

24 W/m 280 LED/m	STP20401	2700 K	2064	86	2216
	STP20402	3000 K	2112	88	2216
	STP20403	4000 K	2400	100	2216

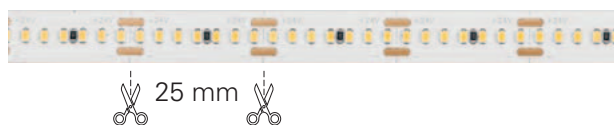

28,8 W/m 350 LED/m	STP20501	2700 K	2505	87	2216
	STP20502	3000 K	2592	90	2216
	STP20503	4000 K	2880	100	2216

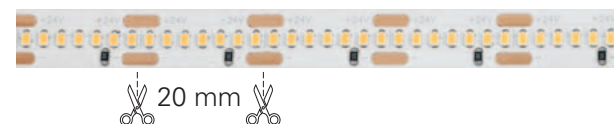

12 mm.	24 W/m 700 LED/m	STP10030	2700 K	2088	87	2110
		STP10031	3000 K	2136	89	2110
		STP10032	4000 K	2352	98	2110

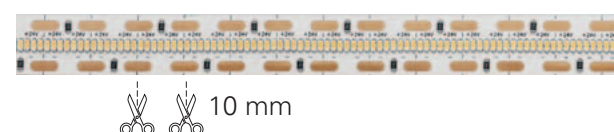

(*) La garanzia è valida solo se la Striped è installata su superficie alluminio idonea a garantire la corretta dissipazione del calore.
 (*) Warranty is valid only if the Striped are mounted on an aluminium heat-dissipating surface.

Light Line Waterproof Striped

La serie Waterproof completa la gamma Striped Light Line con le versioni IP65, IP66 e IP67, utilizzabili sia in interni che in esterni. Le versioni con IP65 si prestano facilmente all'utilizzo in interni perchè resistono alla polvere e favoriscono il mantenimento di una perfetta pulizia della strip. I modelli con grado di protezione superiore sono racchiusi in un involucro in silicone che garantisce una perfetta tenuta all'acqua e non altera la qualità dell'emissione luminosa.

The Waterproof serie completes the Striped Light Line range with the different IP65, IP66 and IP67 versions, useful also per indoor installations.

The versions with IP65 are ideal for indoor use.

They are dust-resistant and easy to be kept clean.

The versions with a higher degree of protection are encased in a silicone casing which guarantees perfect water tightness without altering the quality of the light emission.





Villa privata - Pescara (PE) Italy

Light Line Waterproof Striped

◆ 24 V DC UP TO IP67 UP TO 92 lm/W PCB 8/10/12 mm. CRI > 80 5^{ROLL}m. **3M** 5 YEARS WARRANTY

La serie Waterproof completa la gamma Striped Light Line con le versioni IP65, IP66 e IP67, utilizzabili sia in interni che in esterni. Le versioni con IP65 si prestano facilmente all'uso in interni perchè resistono alla polvere e favoriscono il mantenimento di una perfetta pulizia della strip. I modelli con grado di protezione superiore sono racchiusi in un involucro in silicone che garantisce una perfetta tenuta all'acqua e non altera la qualità dell'emissione luminosa.

The Waterproof serie completes the Striped Light Line range with the different IP65, IP66 and IP67 versions, useful also per indoor installations. The versions with IP65 are ideal for indoor use. They are dust-resistant and easy to be kept clean. The versions with a higher degree of protection are encased in a silicone casing which guarantees perfect water tightness without altering the quality of the light emission.



(*) La garanzia è valida solo se la Striped è installata su superficie alluminio idonea a garantire la corretta dissipazione del calore.
(*) Warranty is valid only if the Striped are mounted on an aluminium heat-dissipating surface.

Light Line Waterproof

Stripled 24V DC

IP 65

dimensione size	potenza power	codice code	CCT CCT	lm/m. lm/m.	lm/W. lm/W.	modello LED LED model
8 mm.	4,8 W/m	STP65102	3000 K	340	85	3528
IP65	60 LED/m	STP65103	4000 K	360	90	3528

CRI > 80

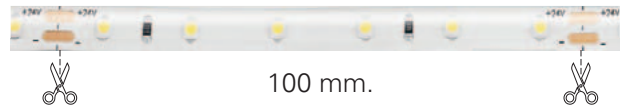

100 mm.



12 mm.	19,2 W/m	STP65302	3000 K	1632	85	3528
IP65	240 LED/m	STP65303	4000 K	1728	90	3528

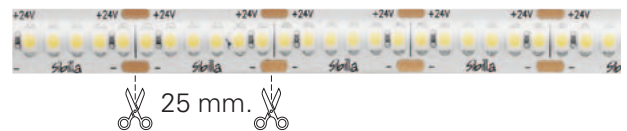

25 mm.



IP 66

dimensione size	potenza power	codice code	CCT CCT	lm/m. lm/m.	lm/W. lm/W.	modello LED LED model
10 mm.	9,6 W/m	STP65110	2700 K	816	85	2110
IP66	140 LED/m	STP65111	3000 K	835	87	2110
		STP65112	4000 K	922	96	2110

CRI > 90

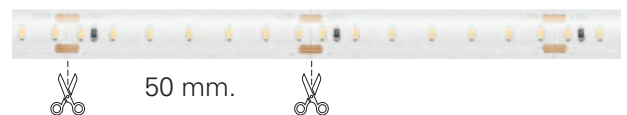

50 mm.



12 mm.	14,4 W/m	STP65120	2700 K	1166	81	2110
IP66	210 LED/m	STP65121	3000 K	1195	83	2110
		STP65122	4000 K	1324	92	2110

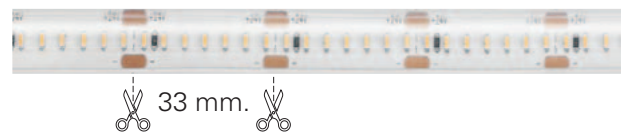

33 mm.



IP 67

dimensione size	potenza power	codice code	CCT CCT	lm/m. lm/m.	lm/W. lm/W.	modello LED LED model
12 mm.	19,2 W/m	STP65130	2700 K	1209	63	2835
IP67	140 LED/m	STP65131	3000 K	1305	68	2835
		STP65132	4000 K	1382	72	2835

CRI > 90

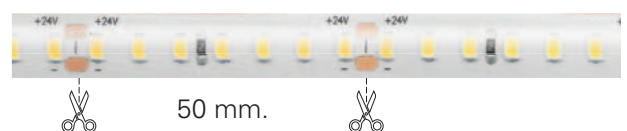

50 mm.



High Efficiency Stripled

◆ 24 V DC UP TO 126 lm/W PCB 10 mm. CRI > 90 5^{ROLL}m. 3M 5 YEARS WARRANTY

L'impiego di un nuovo e particolare package ha permesso la creazione delle High Efficiency Stripled, la soluzione ideale per linee di luce ad elevatissima efficienza luminosa. Il già noto e collaudato emitter 2835 trova nuova vita in questa formula innovativa che raccoglie e sintetizza le eccellenze dei materiali di ultima generazione. Le High Efficiency Stripled offrono elevati rendimenti che si combinano con una ottima resa cromatica che si mantiene sempre a livelli di eccellenza. L'impiego di queste strip è indicato nei grandi spazi, nelle applicazioni con luce indiretta oppure dove si richiedono un attento controllo dei costi senza rinunciare alla massima qualità della luce.

A new peculiar package has allowed the creation of High Efficiency Stripled, the ideal solution for lines of light with very high luminous efficiency. The already known 2835 emitter finds new life in this innovative formula that collects and synthesizes the excellence of the latest generation materials. The High Efficiency Stripleds offer high performances combined to an excellent color rendering that always guarantees excellent levels. The use of these strips is indicated in large spaces, in applications with indirect light or where careful cost control is required without having to give up the maximum quality of light.





High Efficiency Stripled 24V DC

dimensione size	potenza power	codice code	CCT CCT	lm/m. lm/m.	lm/W. lm/W.	modello LED LED model
10 mm.	14,4W/m	STP10050	2700 K	1569	109	2835
		STP10051	3000 K	1612	112	2835
		STP10052	4000 K	1713	119	2835
24W/m	160 LED/m	STP10055	2700 K	2736	114	2835
		STP10056	3000 K	2856	119	2835
		STP10057	4000 K	3024	126	2835

CRI >90 - IP 20

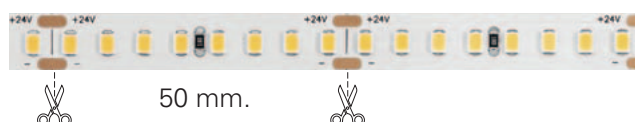

(*) La garanzia è valida solo se la Stripled è installata su superficie alluminio idonea a garantire la corretta dissipazione del calore.
 (*) Warranty is valid only if the Stripled are mounted on an aluminium heat-dissipating surface.

Color Quality Striped

◆ 24 V DC UP TO 113 lm/W PCB 10 mm. CRI > 95 5^{ROLL} m. 3M 5 YEARS WARRANTY

La serie Color Quality Striped si caratterizza per l'elevato standard di resa cromatica. È indicata per applicazioni particolari dove si richiede la perfetta restituzione dei colori; l'apprezzamento dei colori è garantito dall'ottimale miscelazione del flusso emesso dai singoli emitter, senza che venga così penalizzata l'efficacia luminosa che rimane sempre su livelli di eccellenza. Questo connubio rende le Color Quality Striped perfette per installazioni nelle vetrine dei negozi, all'interno di show rooms, oppure per applicazioni in ambito museale.

The Color Quality Striped series is characterized by the high standard of color rendering. It is indicated for particular applications where perfect colors are required; the appreciation of the colors is guaranteed by the optimal mixing of the flow emitted by the individual emitters, without thus affecting the luminous efficacy which always remains at excellent levels. This combination makes the Color Quality Striped the perfect choice for installations in shop windows, inside show rooms, or for museum applications.

Color Quality

Stripled 24V DC

dimensione size	potenza power	codice code	CCT CCT	lm/m. lm/m.	lm/W. lm/W.	modello LED LED model
10 mm. 24V DC	14,4 W/m 80 LED/m	STP10040	2700K	1440	100	2835
		STP10041	3000K	1483	103	2835
		STP10042	4000K	1555	108	2835

CRI >95 - IP 20

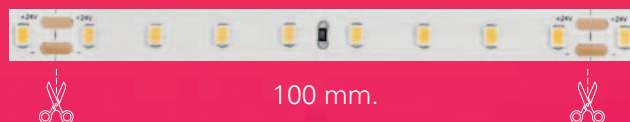

24 W/m 160 LED/m	STP10045	2700K	2448	102	2835
	STP10046	3000K	2568	107	2835
	STP10047	4000K	2712	113	2835

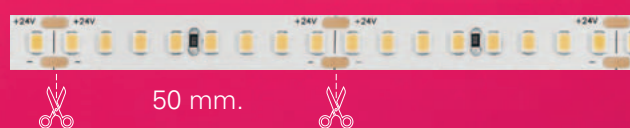

(*) La garanzia è valida solo se la Stripled è installata su superficie alluminio idonea a garantire la corretta dissipazione del calore.
 (*) Warranty is valid only if the Stripled are mounted on an aluminium heat-dissipating surface.

Color Quality Striped

Resa cromatica / *Color rendering*

CRI

R1 - R15

2700 K
CRI: 97,7

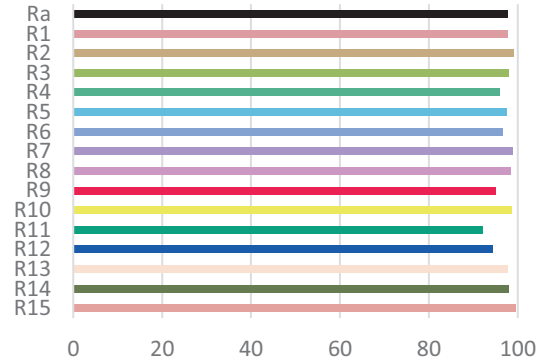
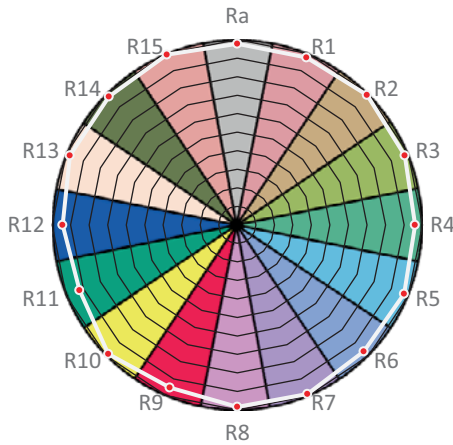

3000 K
CRI: 97,6

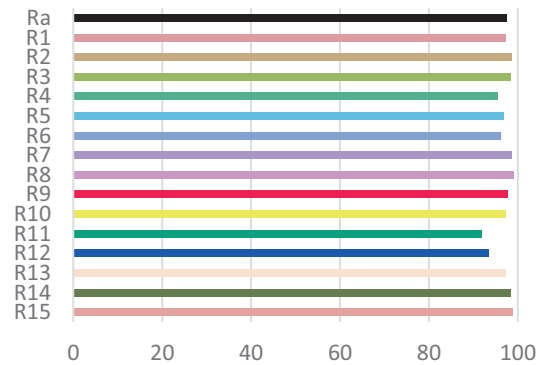
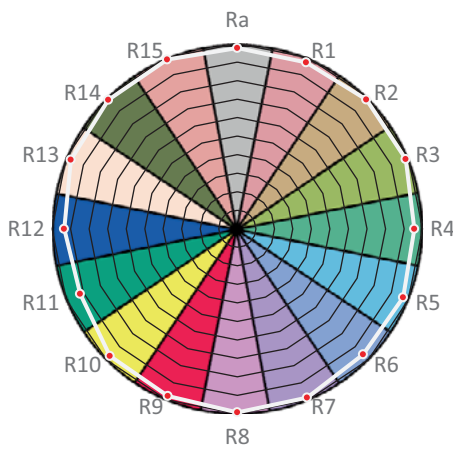

4000 K
CRI: 98,1

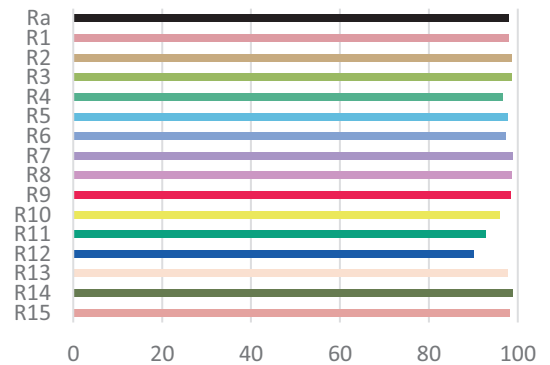
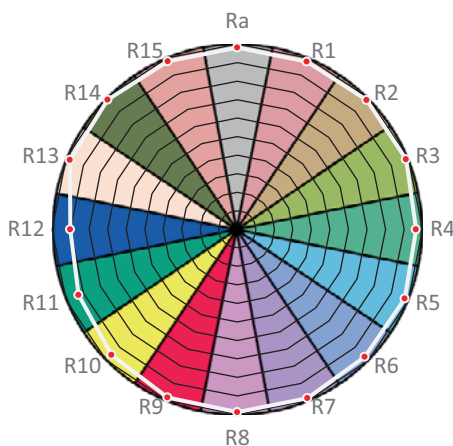

TM-30

Rf / Rg plot

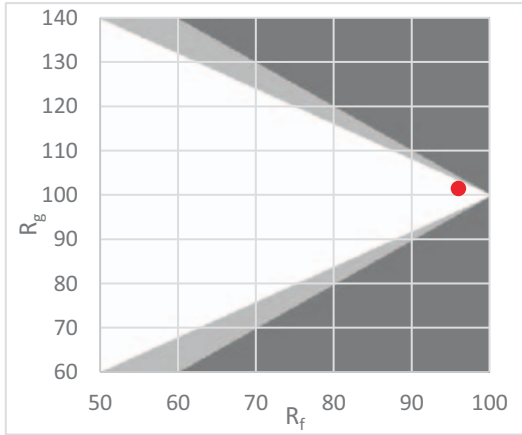

Color vector graphic

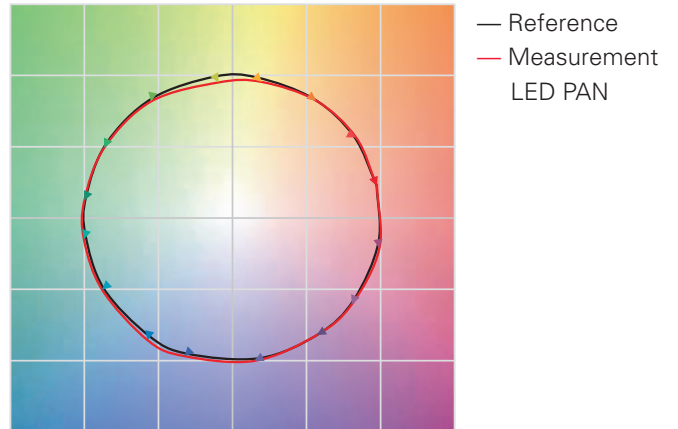
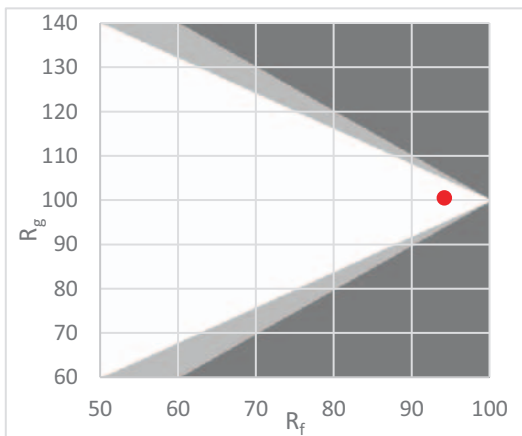
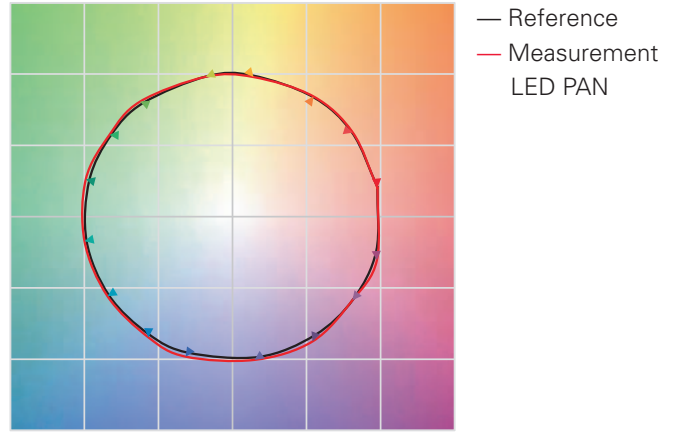
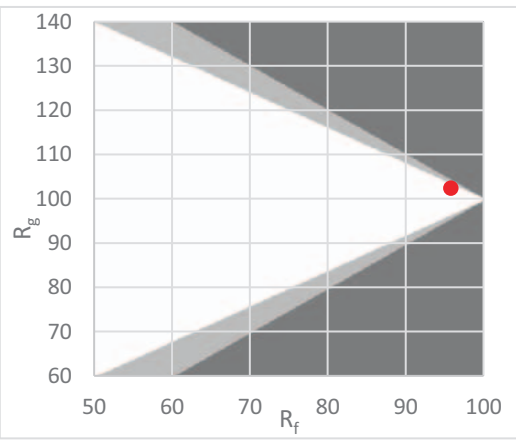
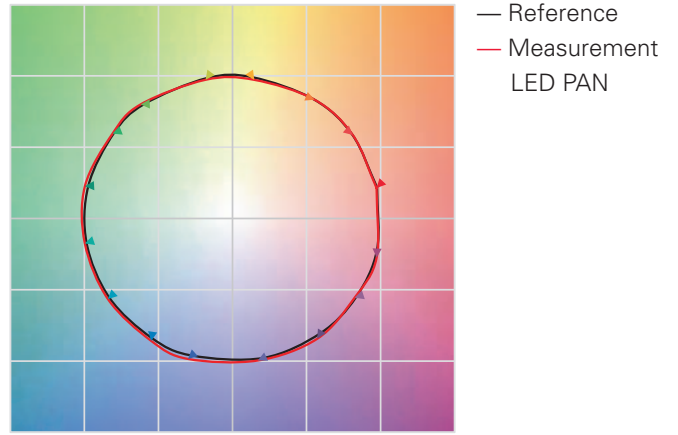

Tunable Striped

◆ 24 V DC PCB 8/10 mm. 2700÷5000 K 5^{ROLL}m. 3M 5 YEARS WARRANTY

Le Striped a colore dinamico presentano contenuti tecnologici all'avanguardia: dotate di circuizione separata che permette la miscelazione del flusso luminoso, permettono di ottenere infinite variabili cromatiche nel colore bianco oppure una perfetta miscelazione del colore. La scala di temperatura di colore può variare tra 2700 K e 5000 K con una fluida transizione attraverso l'universo delle miscele intermedie.

The dynamic chlorinated Striped have cutting-edge technological contents: equipped with separate circuits that allow the mixing of the luminous flux, they allow to obtain infinite chromatic variables in the white color or a perfect mixing of the color. The color temperature scale can vary between 2700 K and 5000 K with a gradual transition through the universe of intermediate mixtures.

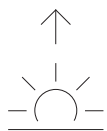

Early morning:
5000 K

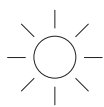

Late morning:
4000 K



Afternoon:
6000 K

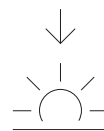

Sunset:
3000 K



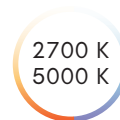
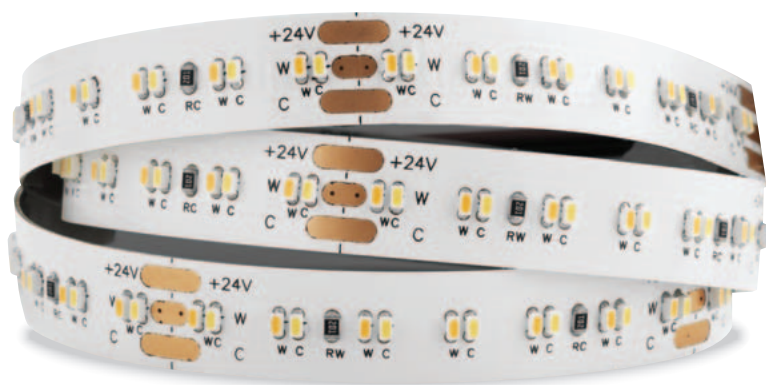

Tunable Stripled 24V DC

dimensione size/w	potenza power	codice code	CCT CCT	lm / metro lm / meter.	modello LED LED type	IP 20
8 mm.	9,6W/m 120 LED/m	STP21005	2700-5000 K	576 lm/m ÷ 768 lm/m	2216	
10 mm.	19,2W/m 280 LED/m	STP21010	2700-5000 K	1344 lm/m ÷ 1728 lm/m	2110	

(*) La garanzia è valida solo se la Stripled è installata su superficie alluminio idonea a garantire la corretta dissipazione del calore.
 (*) Warranty is valid only if the Stripled are mounted on an aluminium heat-dissipating surface.

RGB Striped

III 24 V DC PCB 8/10/14 mm. 5^{ROLL} m. 3M 5 YEARS WARRANTY

In 10 mm. di sezione la serie RGB Striped offre tutti i vantaggi della dinamicità cromatica sia nella tradizionale configurazione con LED 5050, da tempo conosciuti come fra i più affidabili nel tempo, sia nella configurazione con i più recenti LED 2110, emitter di ultima generazione le cui ridottissime dimensioni consentono la perfetta miscelazione delle singole emissioni red / green / blu.

In 10 mm. profile the RGB Striped series offers all the advantages of chromatic dynamism both in the traditional configuration with LED 5050, long known as among the most reliable over time, and in the new configuration with the most recent LED 2110, latest generation emitters whose very small dimensions allow the perfect mixing of the individual red / green / blue emissions.

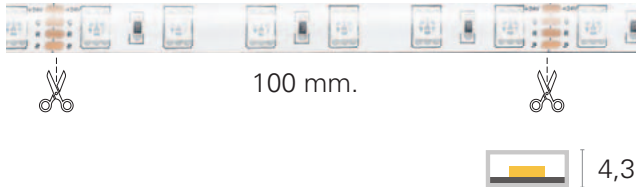
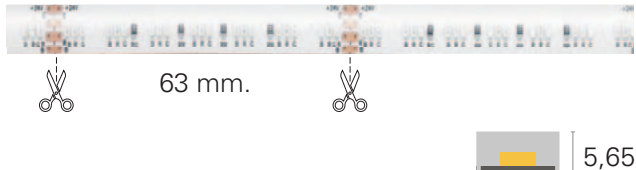

RGB Striped 24V DC

dimensione size	potenza power	codice code	CCT CCT	lm/m. lm/m.	lm/W. lm/W.	modello LED LED model	IP67
10 mm.	14,4 W/m 60 LED/m	STP67202	RGB	\	\	5050	
10 mm.	14,4 W/m 336 LED/m	STP67205	RGB	\	\	2110	

(*) La garanzia è valida solo se la Striped è installata su superficie alluminio idonea a garantire la corretta dissipazione del calore.
 (*) Warranty is valid only if the Striped are mounted on an aluminium heat-dissipating surface.

RGB+W Striped

III 24 V DC PCB 8/10/14 mm. 5^{ROLL} m. 3M 5 YEARS WARRANTY

Nei modelli RGB+W la caratteristica di rilievo è l'impiego del LED 2110, emitter di ultima generazione le cui ridottissime dimensioni consentono un assortimento all'interno del package estremamente ravvicinato: il risultato è una perfetta miscelazione del colore per una percezione cromatica senza incertezze.

In the RGB + W models, the most important feature is the use of LED 2110, the latest generation emitter whose extremely small size has an assortment within the extremely close package: the result is a perfect mix of color for a visual perception of the color without uncertainties.



RGB+W

Striped 24V DC

dimensione size	potenza power	codice code	CCT CCT	lm/m. lm/m.	lm/W. lm/W.	modello LED LED model	IP 20
8 mm.	14,4 W/m 240 LED/m	STP21105	RGB+W 3000 K	\	\	2110	

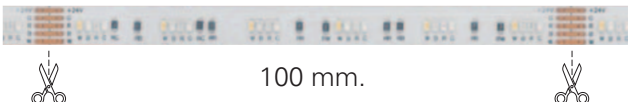

RGB+W

Striped 24V DC

dimensione size	potenza power	codice code	CCT CCT	lm/m. lm/m.	lm/W. lm/W.	modello LED LED model	IP67
10 mm.	14,4 W/m 240 LED/m	STP67210	RGB+W 3000 K	\	\	2110	



5,75

dimensioni size	potenza power	codice code	CCT CCT	lm/m. lm/m.	lm/W. lm/W.	modello LED LED model	IP67
14 mm.	19,2 W/m 60 LED/m	STP67215	RGB+W 3000 K	\	\	5050	







5,5

(*) La garanzia è valida solo se la Striped è installata su superficie alluminio idonea a garantire la corretta dissipazione del calore.
(*) Warranty is valid only if the Striped are mounted on an aluminium heat-dissipating surface.

Sistemi di Controllo / *Control Systems*

Vedi "Drivers e Controllers" a pag. 542 / See "Drivers and Controllers" to pg. 542

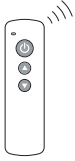
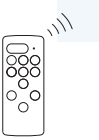
Sistemi di controllo Monocromatici *Monochrome control system*

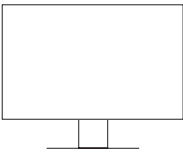
	descrizione <i>description</i>	codice <i>code</i>	+	opzionale <i>optional</i>
	PUSH BUTTON	Dimmer control 360 W		Remote control DRV8005
		Dimmer 192 W		Remote control DRV8005
	TOUCH PANEL	Decoder 4x 120 W		Remote control DRV8008
	REMOTE CONTROL	Dimmer control 360 W		DRV8105
		Dimmer 192 W		DRV8100
	KIT	Dimmer kit 120 W		DRV8201
	SMARTPHONE BLUETOOTH	Mesh Dimmer 360 W		DRV8210
		Wireless PAN DIGITAL dimmer		DRV8310
		CASAMBI Wireless driver		DRV8311
		CASAMBI Bluetooth 4ch PWM dimmer		DRV8312
	MULTI CONTROL	DIN rail Dimmer DALI max. 156 W		DRV9052
		DALI / Push N.O. / 0...10V - 1...10 Analogical / 1...10V Potentiometer		DRV9053
		DIN rail Dimmer DALI max. 480 W		DRV9053
	DMX / Push N.O. / 0...10V - 1...10 Analogical / 1...10V Potentiometer	DIN rail Dimmer DMX max. 480 W		DRV9054



Sistemi di controllo Bianco Variabile *Tunable control system*

Sistemi di controllo RGB+W *RGB+W control system*

descrizione <i>description</i>	codice <i>code</i>	+	opzionale <i>optional</i>	descrizione <i>description</i>	codice <i>code</i>	+	opzionale <i>optional</i>
Dimmer control 360 W	DRV8110	+	Remote control DRV8006	Dimmer control 4x 180 W	DRV8120	+	Remote control DRV8007
CASAMBI Wireless driver	DRV8311			Dimmer max. 240 W	DRV9008	+	Signal amplifier DRV9009
				CASAMBI Wireless driver	DRV8311		
Decoder 4x 120 W	DRV8002 DRV8122	+	Remote control DRV8009	Decoder 4x 120 W	DRV8003 DRV8122	+	Remote control DRV8010
Dimmer control 360 W	DRV8110	+	Remote control DRV8006	Dimmer control 4x 180 W	DRV8120	+	Remote control DRV8007
	\				\		
Tunable White Dimmer kit 144 W	DRV8203			RGB+W Dimmer kit 192 W	DRV8025		
Tunable Mesh Dimmer 336 W	DRV8212			RGB+W Mesh Dimmer	DRV8215		
Wireless PAN DIGITAL	DRV8310			CASAMBI Wireless driver	DRV8311		
CASAMBI Bluetooth 4ch PWM dimmer	DRV8312			CASAMBI Bluetooth 4ch PWM dimmer	DRV8312		
	\				\		
	\				\		
	\				\		

Profili

Nel panorama dell'illuminazione contemporanea i sistemi luminosi lineari occupano spazi sempre più ampi. Essi contribuiscono alla creazione di effetti e soluzioni tecnicamente inimmaginabili nel recente passato. Punto primario della svolta tecnologica sono le stripled di ultima generazione, veri e propri sistemi d'illuminazione che, a costi ragionevoli, garantiscono prestazioni d'eccellenza, qualità luminose di ottimo livello, efficacia e rese cromatiche equiparabili ai migliori standard.

La gamma Profili coniuga diverse peculiarità utili a progettisti ed illuminotecnici, garantendo sempre elevatissimi standard qualitativi. Una scelta diversificata per potenze, efficienza, rese cromatiche e soprattutto impieghi. Un costante ed attento controllo qualitativo rende le strip presenti a catalogo la scelta ideale in ogni applicazione con emissione diretta oppure indiretta.



pg. 107

PRO2130

pg. 108

PRO2050

pg. 108

PRO2040

Profiles

In the contemporary lighting, linear lighting systems occupy increasingly large spaces. They contribute to the creation of technically unimaginable effects and solutions in the recent past. Primary point of the technological breakthrough are the latest generation of the strip LEDs, lighting systems that, at reasonable costs, guarantee excellent performance, excellent quality of light, efficacy and color rendering comparable to the best standards.

The Profili range combines different features useful to designers and lighting technicians, always guaranteeing extremely high quality standards. A diversified choice in terms of power, efficiency, color rendering and above all applications. A constant and careful quality control makes the strips in the catalog the ideal choice in any application with direct or indirect emission.



Stripled + Profili incasso trimless

Stripled + Profile trimless recessed

Stripled - Stripled

modello <i>model</i>	IP <i>IP</i>	dimensione <i>size</i>	CCT <i>CCT</i>	descrizione <i>description</i>	pagina <i>see page</i>
Mini	IP20	4 mm.	2700 K / 3000 K / 4000 K	14,4 W/m - 196 LED/m. - LED 2110	<i>pg.77</i>
CoB line	IP20	4 mm.	2700 K / 3000 K / 4000 K	8 W/m - 728 LED/m. - CoB linear	<i>pg.79</i>
		8 mm.	2700 K / 3000 K / 4000 K	12 W/m - 1092 LED/m. - CoB linear	<i>pg.79</i>
Light line	IP20	8 mm.	2700 K / 3000 K / 4000 K	4,8 W/m - 60 LED/m. - LED 2216	<i>pg.81</i>
				9,6 W/m - 140 LED/m. - LED 2110	<i>pg.81</i>
		10 mm.	2700 K / 3000 K / 4000 K	14,4 W/m - 180 LED/m. - LED 2216	<i>pg.81</i>
				19,2 W/m - 238 LED/m. - LED 2216	<i>pg.81</i>
				19,2 W/m - 280 LED/m. - LED 2110	<i>pg.81</i>
		12 mm.	2700 K / 3000 K / 4000 K	24 W/m - 280 LED/m. - LED 2216	<i>pg.81</i>
				28,8 W/m - 350 LED/m. - LED 2216	<i>pg.81</i>
Light line Waterproof	IP65	8 mm.	3000 K / 4000 K	4,8 W/m - 60 LED/m. - LED 3528	<i>pg.85</i>
				IP66	10 mm.
	IP66	12 mm.	2700 K / 3000 K / 4000 K	14,4 W/m - 210 LED/m. - LED 2110	
				IP66	12 mm.
	IP67	12 mm.	2700 K / 3000 K / 4000 K		
High efficiency	IP20	10 mm.	2700 K / 3000 K / 4000 K	14,4 W/m - 80 LED/m. - LED 2835	<i>pg.87</i>
				24 W/m - 160 LED/m. - LED 2835	<i>pg.87</i>
Color Quality	IP20	10 mm.	2700 K / 3000 K / 4000 K	14,4 W/m - 80 LED/m. - LED 2835	<i>pg.89</i>
				24 W/m - 160 LED/m. - LED 2835	<i>pg.89</i>
Tunable	IP20	8 mm.	2700 K - 5000 K	9,6 W/m - 120 LED/m. - LED 2216	<i>pg.93</i>
		10 mm.		19,2 W/m - 280 LED/m. - LED 2110	<i>pg.93</i>
RGB	IP67	10 mm.	RGB	14,4 W/m - 60 LED/m. - LED 5050	<i>pg.94</i>
				14,4 W/m - 336 LED/m. - LED 2110	<i>pg.94</i>
RGB+W	IP20	10 mm.	RGB + W (3000 K)	14,4 W/m - 240 LED/m. - LED 2110	<i>pg.95</i>
				IP67	10 mm.
	IP67	14 mm.	RGB + W (3000 K)	19,2 W/m - 60 LED/m. - LED 5050	

Stripled + Profili incasso trimmed

Stripled + Profile trimmed recessed

Stripled - Stripled

modello <i>model</i>	IP <i>IP</i>	dimensione <i>size</i>	CCT <i>CCT</i>	descrizione <i>description</i>	pagina <i>see page</i>			
Mini	IP20	4 mm.	2700 K / 3000 K / 4000 K	14,4 W/m - 196 LED/m. - LED 2110	<i>pg.77</i>			
CoB line	IP20	4 mm.	2700 K / 3000 K / 4000 K	8 W/m - 728 LED/m. - CoB linear	<i>pg.79</i>			
		8 mm.	2700 K / 3000 K / 4000 K	12 W/m - 1092 LED/m. - CoB linear	<i>pg.79</i>			
Light line	IP20	8 mm.	2700 K / 3000 K / 4000 K	4,8 W/m - 60 LED/m. - LED 2216	<i>pg.81</i>			
				9,6 W/m - 140 LED/m. - LED 2110	<i>pg.81</i>			
		10 mm.	2700 K / 3000 K / 4000 K	14,4 W/m - 180 LED/m. - LED 2216	<i>pg.81</i>			
				19,2 W/m - 238 LED/m. - LED 2216	<i>pg.81</i>			
				19,2 W/m - 280 LED/m. - LED 2110	<i>pg.81</i>			
		12 mm.	2700 K / 3000 K / 4000 K	24 W/m - 280 LED/m. - LED 2216	<i>pg.81</i>			
				28,8 W/m - 350 LED/m. - LED 2216	<i>pg.81</i>			
Light line Waterproof	IP65	8 mm.	3000 K / 4000 K	4,8 W/m - 60 LED/m. - LED 3528	<i>pg.85</i>			
	IP66	10 mm.	2700 K / 3000 K / 4000 K	9,6 W/m - 140 LED/m. - LED 2110	<i>pg.85</i>			
		12 mm.	2700 K / 3000 K / 4000 K	14,4 W/m - 210 LED/m. - LED 2110	<i>pg.85</i>			
	IP67	12 mm.	2700 K / 3000 K / 4000 K	3000 K / 4000 K	19,2 W/m - 240 LED/m. - LED 3528	<i>pg.85</i>		
				2700 K / 3000 K / 4000 K	19,2 W/m - 140 LED/m. - LED 2835	<i>pg.85</i>		
High efficiency	IP20	10 mm.	2700 K / 3000 K / 4000 K	14,4 W/m - 80 LED/m. - LED 2835	<i>pg.87</i>			
				24 W/m - 160 LED/m. - LED 2835	<i>pg.87</i>			
Color Quality	IP20	10 mm.	2700 K / 3000 K / 4000 K	14,4 W/m - 80 LED/m. - LED 2835	<i>pg.89</i>			
				24 W/m - 160 LED/m. - LED 2835	<i>pg.89</i>			
Tunable	IP20	8 mm.	2700 K - 5000 K	9,6 W/m - 120 LED/m. - LED 2216	<i>pg.93</i>			
		10 mm.		19,2 W/m - 280 LED/m. - LED 2110	<i>pg.93</i>			
RGB	IP67	10 mm.	RGB	14,4 W/m - 60 LED/m. - LED 5050	<i>pg.94</i>			
				14,4 W/m - 336 LED/m. - LED 2110	<i>pg.94</i>			
RGB+W	IP20	10 mm.	RGB + W (3000 K)	14,4 W/m - 240 LED/m. - LED 2110	<i>pg.95</i>			
				IP67	10 mm.	RGB + W (3000 K)	14,4 W/m - 240 LED/m. - LED 2110	<i>pg.95</i>
							14 mm.	RGB + W (3000 K)

Profili - Profiles

da incasso trimmed - *trimmed recessed*

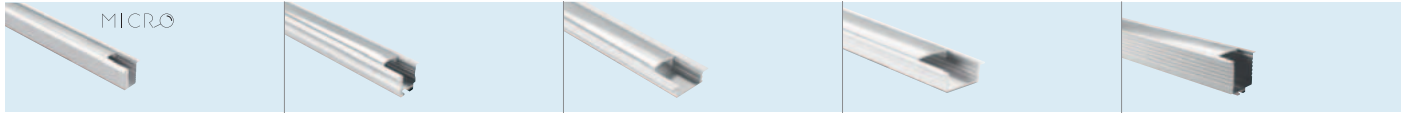

pg.111

pg.111

pg.112

pg.112

pg.113

●				
●				
	●	●	●	●
	●	●	●	●
	●	●	●	●
	●	●	●	●
	●	●	●	●
	●	●	●	●
	●	●	●	●
	●	●	●	●
	●	●	●	●
	●	●	●	●
	●	●	●	●
	●	●	●	●
	●	●	●	●
	●	●	●	●
	●	●	●	●
	●	●	●	●
	●	●	●	●
	●	●	●	●
	●	●	●	●
	●	●	●	●
	●	●	●	●
	●	●	●	●
	●	●	●	●
	●	●	●	●
	●	●	●	●
	●	●	●	●
	●	●	●	●
	●	●	●	●
	●	●	●	●
	●	●	●	●
	●	●	●	●
	●	●	●	●
	●	●	●	●
	●	●	●	●
	●	●	●	●
	●	●	●	●
	●	●	●	●
	●	●	●	●
	●	●	●	●
	●	●	●	●

I Profili sono utilizzabili solo in ambienti interni / Profiles only for indoor use.

Stripled + Profili da superficie







Stripled + Profile surface mounted

Stripled - Stripled

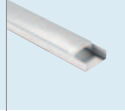
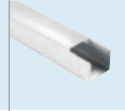
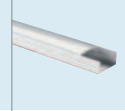
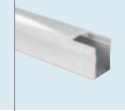
modello <i>model</i>	IP <i>IP</i>	dimensione <i>size</i>	CCT <i>CCT</i>	descrizione <i>description</i>	pagina <i>see page</i>	
Mini	IP20	4 mm.	2700 K / 3000 K / 4000 K	14,4 W/m - 196 LED/m. - LED 2110	<i>pg.77</i>	
CoB line	IP20	4 mm.	2700 K / 3000 K / 4000 K	8 W/m - 728 LED/m. - CoB linear	<i>pg.79</i>	
		8 mm.	2700 K / 3000 K / 4000 K	12 W/m - 1092 LED/m. - CoB linear	<i>pg.79</i>	
Light line	IP20	8 mm.	2700 K / 3000 K / 4000 K	4,8 W/m - 60 LED/m. - LED 2216	<i>pg.81</i>	
				9,6 W/m - 140 LED/m. - LED 2110	<i>pg.81</i>	
		10 mm.	2700 K / 3000 K / 4000 K	14,4 W/m - 180 LED/m. - LED 2216	<i>pg.81</i>	
				19,2 W/m - 238 LED/m. - LED 2216	<i>pg.81</i>	
				19,2 W/m - 280 LED/m. - LED 2110	<i>pg.81</i>	
		12 mm.	2700 K / 3000 K / 4000 K	24 W/m - 280 LED/m. - LED 2216	<i>pg.81</i>	
				28,8 W/m - 350 LED/m. - LED 2216	<i>pg.81</i>	
Light line Waterproof	IP65	8 mm.	3000 K / 4000 K	4,8 W/m - 60 LED/m. - LED 3528	<i>pg.85</i>	
	IP66	10 mm.	2700 K / 3000 K / 4000 K	9,6 W/m - 140 LED/m. - LED 2110	<i>pg.85</i>	
		12 mm.	2700 K / 3000 K / 4000 K	14,4 W/m - 210 LED/m. - LED 2110	<i>pg.85</i>	
	IP67	12 mm.	2700 K / 3000 K / 4000 K	3000 K / 4000 K	19,2 W/m - 240 LED/m. - LED 3528	<i>pg.85</i>
				2700 K / 3000 K / 4000 K	19,2 W/m - 140 LED/m. - LED 2835	<i>pg.85</i>
High efficiency	IP20	10 mm.	2700 K / 3000 K / 4000 K	14,4 W/m - 80 LED/m. - LED 2835	<i>pg.87</i>	
				24 W/m - 160 LED/m. - LED 2835	<i>pg.87</i>	
Color Quality	IP20	10 mm.	2700 K / 3000 K / 4000 K	14,4 W/m - 80 LED/m. - LED 2835	<i>pg.89</i>	
				24 W/m - 160 LED/m. - LED 2835	<i>pg.89</i>	
Tunable	IP20	8 mm.	2700 K - 5000 K	9,6 W/m - 120 LED/m. - LED 2216	<i>pg.93</i>	
		10 mm.		19,2 W/m - 280 LED/m. - LED 2110	<i>pg.93</i>	
RGB	IP67	10 mm.	RGB	14,4 W/m - 60 LED/m. - LED 5050	<i>pg.94</i>	
				14,4 W/m - 336 LED/m. - LED 2110	<i>pg.94</i>	
RGB+W	IP20	10 mm.	RGB + W (3000 K)	14,4 W/m - 240 LED/m. - LED 2110	<i>pg.95</i>	
				IP67	10 mm.	RGB + W (3000 K)
			14 mm.	RGB + W (3000 K)	19,2 W/m - 60 LED/m. - LED 5050	<i>pg.95</i>

Profili - Profiles

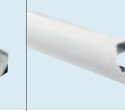
da superficie / surface mounted

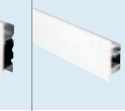
 MICRO pg.116	 pg.117	 pg.118	 pg.118	 pg.119	 pg.119	 MICRO pg.120	 pg.120	 pg.121	 pg.121	 pg.122
●						●				
●						●				
	●	●	●	●	●		●	●	●	●
	●	●	●	●	●		●	●	●	●
	●	●	●	●	●		●	●	●	●
	●	●	●	●	●		●	●	●	●
	●	●	●	●	●		●	●	●	●
	●	●	●	●	●		●	●	●	●
	●	●	●	●	●		●	●	●	●
	●	●	●	●	●		●	●	●	●
	●	●	●	●	●		●	●	●	●
	●	●	●	●	●		●	●	●	●
	●	●	●	●	●		●	●	●	●
	●	●	●	●	●		●	●	●	●
	●	●	●	●	●		●	●	●	●
	●	●	●	●	●		●	●	●	●
	●	●	●	●	●		●	●	●	●
	●	●	●	●	●		●	●	●	●
	●	●	●	●	●		●	●	●	●
	●	●	●	●	●		●	●	●	●
	●	●	●	●	●		●	●	●	●
	●	●	●	●	●		●	●	●	●
	●	●	●	●	●		●	●	●	●
	●	●	●	●	●		●	●	●	●
	●	●	●	●	●		●	●	●	●
	●	●	●	●	●		●	●	●	●
	●	●	●	●	●		●	●	●	●

I Profili sono utilizzabili solo in ambienti interni / Profiles only for indoor use.

Profili da incasso trimless

Profiles trimless recessed

figura model	descrizione description	pezzi pieces	colore color	codice code
MICRO	profilo preforato 200 cm. completo di diffusore opale <i>drilled profile 200 cm. opal diffuser included</i>	1 x	profilo alluminio diffusore opale bianco <i>profile aluminum opal white diffuser</i>	PRO2001

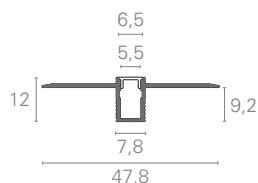

Accessori / Accessories

tappi terminali in plastica <i>plastic end caps</i>		2 x	grigio <i>grey</i>	PRO2008
--	---	-----	-----------------------	----------------

Ricambi / Spare Parts

schermo opalino 200 cm. <i>opal diffuser 200 cm.</i>		1 x	opale bianco <i>opal white</i>	PRO2005
---	--	-----	-----------------------------------	----------------

figura model	descrizione description	pezzi pieces	colore color	codice code
	profilo preforato 200 cm. completo di diffusore opale <i>drilled profile 200 cm. opal diffuser included</i>	1 x	profilo alluminio diffusore opale bianco <i>profile aluminum opal white diffuser</i>	PRO2060

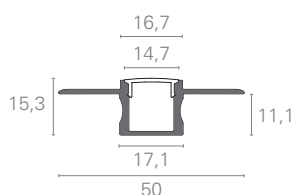

Accessori / Accessories

schermo trasparente 200 cm. <i>transparent louvre 200 cm.</i>		1 x	trasparente <i>transparent</i>	PRO2064
--	---	-----	-----------------------------------	----------------



tappi terminali in plastica <i>plastic end caps</i>		2 x	grigio <i>grey</i>	PRO2067
--	---	-----	-----------------------	----------------

Ricambi / Spare Parts

schermo opalino 200 cm. <i>opal diffuser 200 cm.</i>		1 x	opale bianco <i>opal white</i>	PRO2063
---	---	-----	-----------------------------------	----------------

figura model	descrizione description	pezzi pieces	colore color	codice code
	profilo preforato 200 cm. completo di diffusore opale <i>drilled profile 200 cm. opal diffuser included</i>	1 x	profilo alluminio diffusore opale bianco <i>profile aluminum opal white diffuser</i>	PRO2130

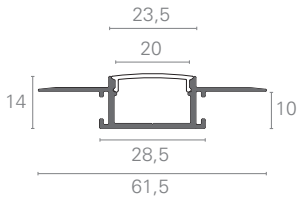
Accessori / Accessories

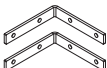
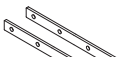

	tappi terminali in plastica <i>plastic end caps</i>		2 x	grigio <i>grey</i>	PRO2136
	giunzione angolare <i>corner junction</i>		2 x	\	PRO2137
	giunzione lineare <i>linear junction</i>		2 x	\	PRO2138

Ricambi / Spare Parts

	schermo opalino 200 cm. <i>opal diffuser 200 cm.</i>		1 x	opale bianco <i>opal white</i>	PRO2134
--	---	---	-----	-----------------------------------	----------------

figura model	descrizione description	pezzi pieces	colore color	codice code
	profilo preforato 200 cm. completo di diffusore opale <i>drilled profile 200 cm. opal diffuser included</i>	1 x	profilo alluminio diffusore opale bianco <i>profile aluminum opal white diffuser</i>	PRO2101

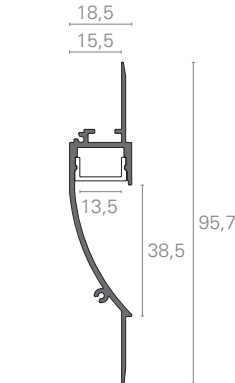
Accessori / Accessories

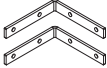
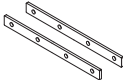



	tappi terminali in plastica <i>plastic end caps</i>		2 x	bianco <i>white</i>	PRO2108
	giunzione angolare <i>corner junction</i>		2 x	\	PRO2103
	giunzione lineare <i>linear junction</i>		2 x	\	PRO2104

Ricambi / Spare Parts

	schermo opalino 200 cm. <i>opal diffuser 200 cm.</i>		1 x	opale bianco <i>opal white</i>	PRO2106
--	---	---	-----	-----------------------------------	----------------

Profili da incasso trimless

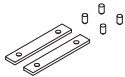
Profiles trimless recessed

figura model	descrizione description	pezzi pieces	colore color	codice code	
MICRO 	profilo preforato 200 cm. completo di diffusore opale <i>drilled profile 200 cm. opal diffuser included</i>	1 x	profilo alluminio diffusore opale bianco <i>profile aluminum opal white diffuser</i>	PRO2040	
	Accessori / Accessories				
	tappi terminali in plastica <i>plastic end caps</i>		2 x	grigio <i>grey</i>	PRO2046
	staffa <i>bracket</i>		2 x \	PRO2048	
	Ricambi / Spare Parts				
	schermo opalino 200 cm. <i>opal diffuser 200 cm.</i>		1 x	opale bianco <i>opal white</i>	PRO2043







figura model	descrizione description	pezzi pieces	colore color	codice code	
MICRO 	profilo preforato 200 cm. completo di diffusore opale <i>drilled profile 200 cm. opal diffuser included</i>	1 x	profilo alluminio diffusore opale bianco <i>profile aluminum opal white diffuser</i>	PRO2050	
	Accessori / Accessories				
	tappi terminali in plastica <i>plastic end caps</i>		2 x	grigio <i>grey</i>	PRO2046
	staffa di fissaggio <i>fixing bracket</i>		2 x \	PRO2048	
	Ricambi / Spare Parts				
	schermo opalino 200 cm. <i>opal diffuser 200 cm.</i>		1 x	opale bianco <i>opal white</i>	PRO2053

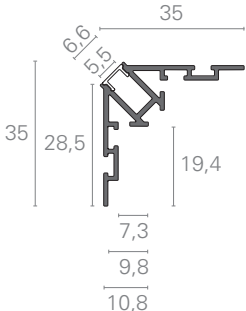

Installazione del profilo in angolo esterno
Profile mounting in external corner

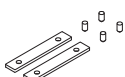

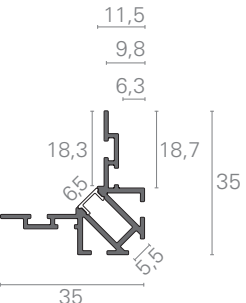
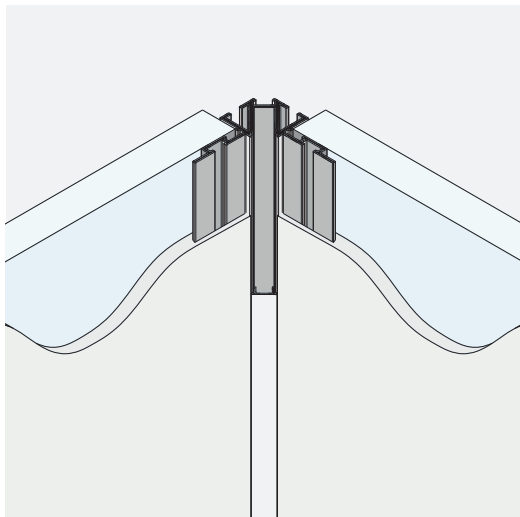
Installazione del profilo in angolo interno
Profile mounting in internal corner

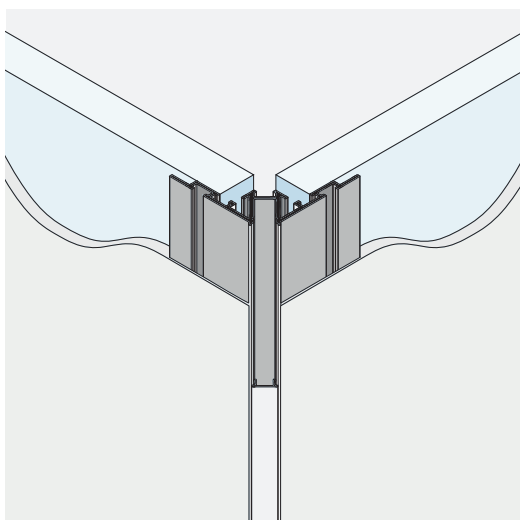

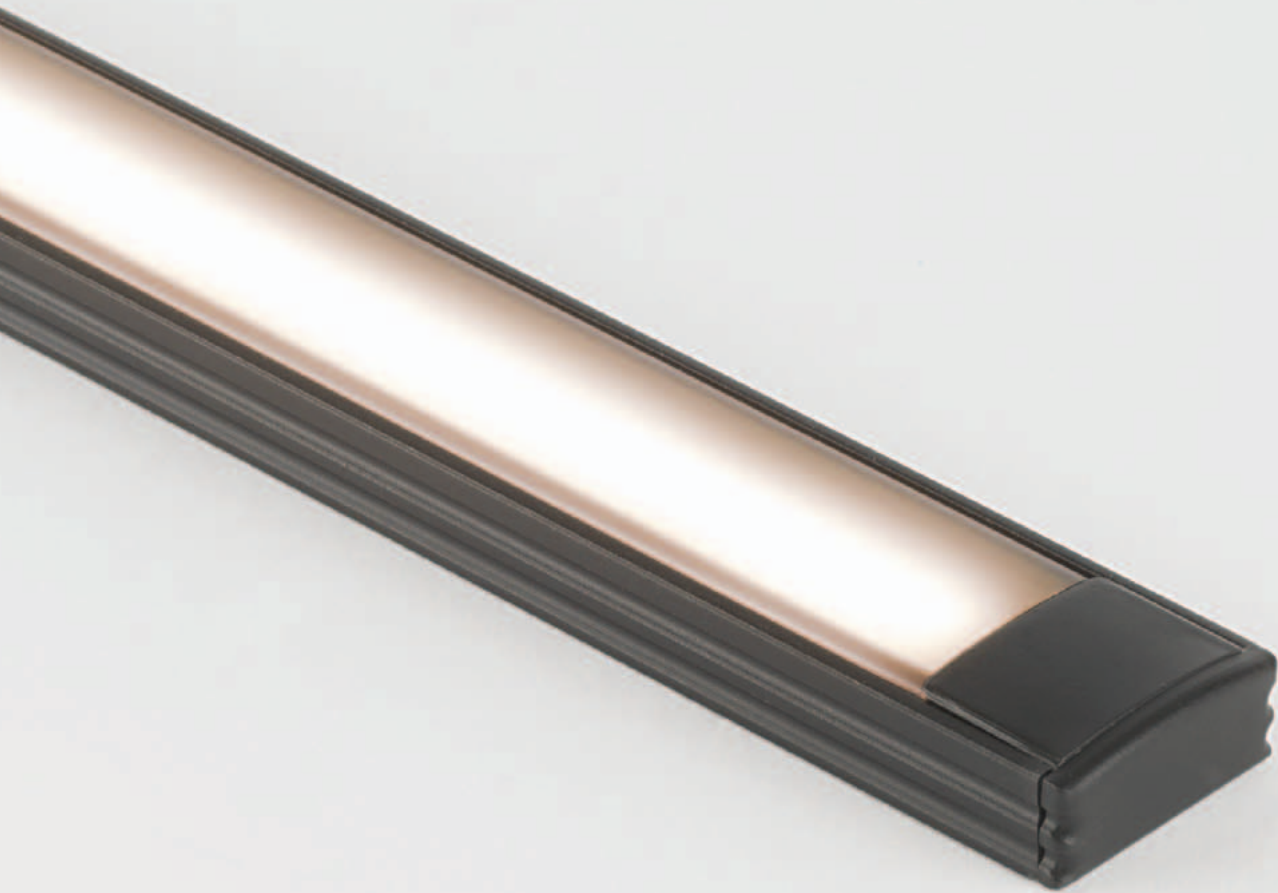

Bianco
White



Alluminio
Aluminum



Nero
Black



Profili da incasso trimmed

Profiles trimmed recessed











figura model	descrizione description	pezzi pieces	colore color	codice code	
<p>MICRO</p>  	profilo 200 cm. completo di diffusore opale <i>profile 200 cm. opal diffuser included</i>	1 x	profilo alluminio diffusore opale bianco <i>profile aluminum opal white diffuser</i>	PRO2020	
			profilo bianco diffusore opale bianco <i>profile white opal white diffuser</i>	PRO2021	
			profilo nero diffusore opale nero <i>profile black opal black diffuser</i>	PRO2022	
	Accessori / Accessories				
	tappi terminali in plastica <i>plastic end caps</i>		2 x	grigio <i>grey</i>	PRO2026
				bianco <i>white</i>	PRO2027
				nero <i>black</i>	PRO2028
	clips di fissaggio <i>fixing clips</i>		2 x	\	PRO2029
	Ricambi / Spare Parts				
	schermo diffusore 200 cm. <i>diffuser 200 cm.</i>		1 x	opale bianco <i>opal white</i>	PRO2005
			opale nero <i>opal black</i>	PRO2006	

figura model	descrizione description	pezzi pieces	colore color	codice code	
 	profilo 200 cm. completo di diffusore opale <i>profile 200 cm. opal diffuser included</i>	1 x	profilo alluminio diffusore opale bianco <i>profile aluminum opal white diffuser</i>	PRO2090	
			profilo bianco diffusore opale bianco <i>profile white opal white diffuser</i>	PRO2091	
	Accessori / Accessories				
	schermo trasparente 200 cm. <i>transparent louvre 200 cm.</i>		1 x	trasparente <i>transparent</i>	PRO2085
	tappi terminali in plastica <i>plastic end caps</i>		2 x	grigio <i>grey</i>	PRO2097
				bianco <i>white</i>	PRO2098
	clips di fissaggio <i>fixing clips</i>		2 x	\	PRO2099
	Ricambi / Spare Parts				
	schermo diffusore 200 cm. <i>diffuser 200 cm.</i>		1 x	opale bianco <i>opal white</i>	PRO2084

Profili da incasso trimmed

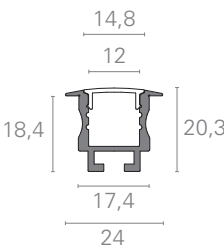
Profiles trimmed recessed

figura model	descrizione description	pezzi pieces	colore color	codice code
	profilo 200 cm. completo di diffusore opale <i>profile 200 cm. opal diffuser included</i>	1 x	profilo alluminio diffusore opale bianco <i>profile aluminum opal white diffuser</i>	PRO2080
			profilo bianco diffusore opale bianco <i>profile white opal white diffuser</i>	PRO2081
			profilo nero diffusore opale nero <i>profile black opal black diffuser</i>	PRO2082
Accessori / Accessories				
	schermo trasparente 200 cm. <i>transparent louvre 200 cm.</i>	1 x	trasparente <i>transparent</i>	PRO2085
	tappi terminali in plastica <i>plastic end caps</i>	2 x	grigio <i>grey</i>	PRO2087
			bianco <i>white</i>	PRO2088
			nero <i>black</i>	PRO2092
	clips di fissaggio <i>fixing clips</i>	2 x	\	PRO2089
Ricambi / Spare Parts				
	schermo diffusore 200 cm. <i>diffuser 200 cm.</i>	1 x	opale bianco <i>opal white</i>	PRO2084
			opale nero <i>opal black</i>	PRO2086

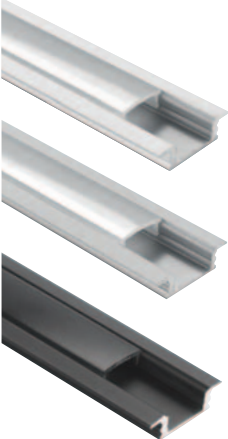

figura model	descrizione description	pezzi pieces	colore color	codice code
	profilo 200 cm. completo di diffusore opale <i>profile 200 cm. opal diffuser included</i>	1 x	profilo alluminio diffusore opale bianco <i>profile aluminum opal white diffuser</i>	PRO1021
			profilo bianco diffusore opale bianco <i>profile white opal white diffuser</i>	PRO1022
			profilo nero diffusore opale nero <i>profile black opal black diffuser</i>	PRO1023
Accessori / Accessories				
	schermo trasparente 200 cm. <i>transparent louvre 200 cm.</i>	1 x	trasparente <i>transparent</i>	PRO1021C
	tappi terminali in plastica <i>plastic end caps</i>	2 x	grigio <i>grey</i>	PRO1037
			bianco <i>white</i>	PRO1037B
	clips di fissaggio <i>fixing clips</i>	2 x	\	PRO1030
Ricambi / Spare Parts				
	schermo diffusore 200 cm. <i>diffuser 200 cm.</i>	1 x	opale bianco <i>opal white</i>	PRO1021B



figura model	descrizione description	pezzi pieces	colore color	codice code
-----------------	----------------------------	-----------------	-----------------	----------------

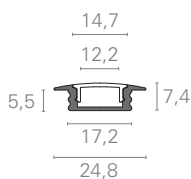
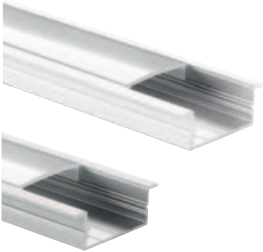

profilo 200 cm. completo di
diffusore opale
*profile 200 cm. opal diffuser
included*

1 x profilo alluminio
diffusore opale bianco
*profile aluminum
opal white diffuser*

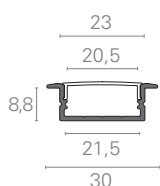
PRO1015

Accessori / Accessories

tappi terminali in plastica
plastic end caps

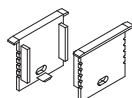

2 x grigio
grey

PRO1035

clips di fissaggio
fixing clips



2 x \

PRO1039

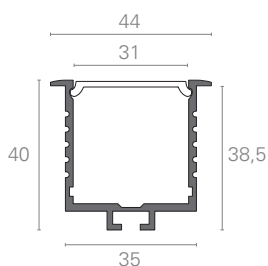

Ricambi / Spare Parts

schermo diffusore 200 cm.
diffuser 200 cm.



1 x opale bianco
opal white

PRO1016





Profili da superficie

Profiles surface mounted

figura model	descrizione description	pezzi pieces	colore color	codice code
MICRO 	profilo 200 cm. completo di diffusore opale <i>profile 200 cm. opal diffuser included</i>	1 x	profilo alluminio diffusore opale bianco <i>profile aluminum opal white diffuser</i>	PRO2010
			profilo bianco diffusore opale bianco <i>profile white opal white diffuser</i>	PRO2011
			profilo nero diffusore opale nero <i>profile black opal black diffuser</i>	PRO2012
Accessori / Accessories				
	tappi terminali in plastica <i>plastic end caps</i>	2 x	grigio <i>grey</i>	PRO2017
			bianco <i>white</i>	PRO2018
			nero <i>black</i>	PRO2019
Ricambi / Spare Parts				
	schermo diffusore 200 cm. <i>diffuser 200 cm.</i>	1 x	opale bianco <i>opal white</i>	PRO2005
			opale nero <i>opal black</i>	PRO2006



figura model	descrizione description	pezzi pieces	colore color	codice code
	profilo 200 cm. completo di diffusore opale <i>profile 200 cm. opal diffuser included</i>	1 x	profilo alluminio diffusore opale bianco <i>profile aluminum opal white diffuser</i>	PRO1025
			profilo bianco diffusore opale bianco <i>profile white opal white diffuser</i>	PRO1026
			profilo nero diffusore opale nero <i>profile black opal black diffuser</i>	PRO1027
Accessori / Accessories				
	schermo trasparente 200 cm. <i>transparent louvre 200 cm.</i>	1 x	trasparente <i>transparent</i>	PRO1025C
	tappi terminali in plastica <i>plastic end caps</i>	2 x	grigio <i>grey</i>	PRO1025D
			bianco <i>white</i>	PRO1026D
			nero <i>black</i>	PRO1027D
	clips di fissaggio <i>fixing clips</i>	2 x	\	PRO1028
	clips di fissaggio orientabili <i>adjustable fixing clips</i>	2 x	\	PRO1029
Ricambi / Spare Parts				
	schermo diffusore 200 cm. <i>diffuser 200 cm.</i>	1 x	opale bianco <i>opal white</i>	PRO1025B
			opale nero <i>opal black</i>	PRO1027A

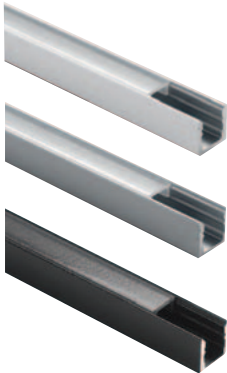
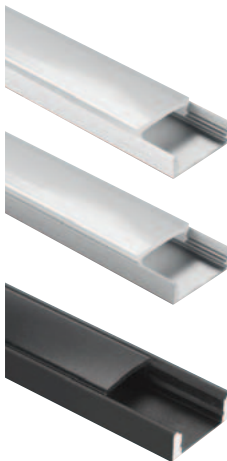
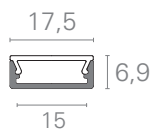

Profili da superficie

Profiles surface mounted







figura model	descrizione description	pezzi pieces	colore color	codice code
	profilo 200 cm. completo di diffusore opale <i>profile 200 cm. opal diffuser included</i>	1 x	profilo alluminio diffusore opale bianco <i>profile aluminum opal white diffuser</i>	PRO2070
			profilo bianco diffusore opale bianco <i>profile white opal white diffuser</i>	PRO2071
Accessori / Accessories				
	schermo trasparente 200 cm. <i>transparent louvre 200 cm.</i>	 1 x	trasparente <i>transparent</i>	PRO1025C
	tappi terminali in plastica <i>plastic end caps</i>		2 x grigio <i>grey</i>	PRO2077
			bianco <i>white</i>	PRO2078
	clips di fissaggio <i>fixing clips</i>	 2 x	\	PRO2079
Ricambi / Spare Parts				
	schermo diffusore 200 cm. <i>diffuser 200 cm.</i>	 1 x	opale bianco <i>opal white</i>	PRO1025B



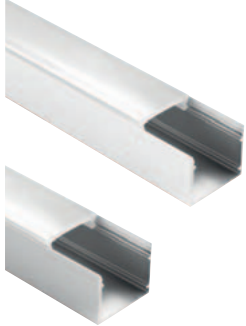

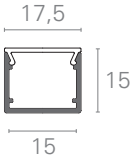

figura model	descrizione description	pezzi pieces	colore color	codice code
	profilo 200 cm. completo di diffusore opale <i>profile 200 cm. opal diffuser included</i>	1 x	profilo alluminio diffusore opale bianco <i>profile aluminum opal white diffuser</i>	PRO1020
			profilo bianco diffusore opale bianco <i>profile white opal white diffuser</i>	PRO1020B
Accessori / Accessories				
	schermo trasparente 200 cm. <i>transparent louvre 200 cm.</i>	 1 x	trasparente <i>transparent</i>	PRO1020E
	tappi terminali in plastica <i>plastic end caps</i>		2 x grigio <i>grey</i>	PRO1036
			bianco <i>white</i>	PRO1036B
	clips di fissaggio <i>fixing clips</i>	 2 x	\	PRO1033
Ricambi / Spare Parts				
	schermo diffusore 200 cm. <i>diffuser 200 cm.</i>	 1 x	opale bianco <i>opal white</i>	PRO1020D

figura model	descrizione description	pezzi pieces	colore color	codice code
	profilo 200 cm. completo di diffusore opale profile 200 cm. opal diffuser included	1 x	profilo bianco diffusore opale bianco profile white opal white diffuser	PRO2140

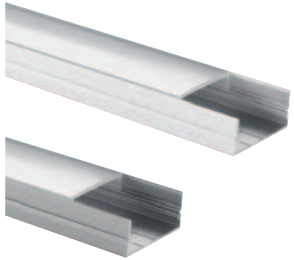
Accessori / Accessories

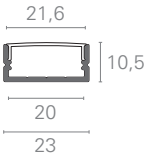
	schermo trasparente 200 cm. transparent louvre 200 cm.	1 x	trasparente transparent	PRO2146
---	---	-----	----------------------------	----------------

	tappi terminali in plastica plastic end caps	2 x	bianco white	PRO2147
---	---	-----	-----------------	----------------

Ricambi / Spare Parts



	schermo diffusore 200 cm. diffuser 200 cm.	1 x	opale bianco opal white	PRO2145
---	---	-----	----------------------------	----------------

figura model	descrizione description	pezzi pieces	colore color	codice code
	profilo 200 cm. completo di diffusore opale profile 200 cm. opal diffuser included	1 x	profilo alluminio diffusore opale bianco profile aluminum opal white diffuser	PRO1013
			profilo bianco diffusore opale bianco profile white opal white diffuser	PRO1013A

Accessori / Accessories

	schermo trasparente 200 cm. transparent louvre 200 cm.	1 x	trasparente transparent	PRO1013C
---	---	-----	----------------------------	-----------------

	tappi terminali in plastica plastic end caps	2 x	grigio grey	PRO1034
---	---	-----	----------------	----------------

			bianco white	PRO1034B
--	--	--	-----------------	-----------------

Ricambi / Spare Parts

	schermo diffusore 200 cm. diffuser 200 cm.	1 x	opale bianco opal white	PRO1013B
---	---	-----	----------------------------	-----------------

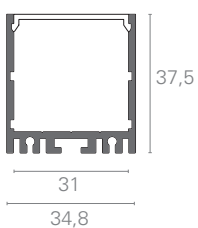
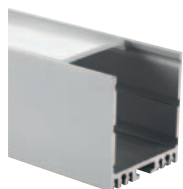
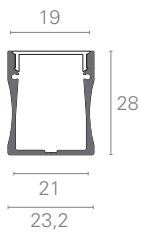

Profili da superficie

Profiles surface mounted

figura model	descrizione description	pezzi pieces	colore color	codice code
MICRO 	profilo 200 cm. completo di diffusore opale profile 200 cm. opal diffuser included	1 x	profilo alluminio diffusore opale bianco <i>profile aluminum opal white diffuser</i>	PRO2030
			profilo bianco diffusore opale bianco <i>profile white opal white diffuser</i>	PRO2031
Accessori / Accessories				
	tappi terminali in plastica <i>plastic end caps</i>	2 x	grigio <i>grey</i>	PRO2036
			bianco <i>white</i>	PRO2037
	clips di fissaggio <i>fixing clips</i>	2 x	\	PRO2039
Ricambi / Spare Parts				
	schermo diffusore 200 cm. <i>diffuser 200 cm.</i>	1 x	opale bianco <i>opal white</i>	PRO2005





figura model	descrizione description	pezzi pieces	colore color	codice code
	profilo 200 cm. completo di diffusore opale <i>profile 200 cm. opal diffuser included</i>	1 x	profilo alluminio diffusore opale bianco <i>profile aluminum opal white diffuser</i>	PRO1040
Accessori / Accessories				
	schermo trasparente 200 cm. <i>transparent louvre 200 cm.</i>	1 x	trasparente <i>transparent</i>	PRO1046
	tappi terminali in plastica <i>plastic end caps</i>	2 x	grigio <i>grey</i>	PRO1041
	clips di fissaggio <i>fixing clips</i>	2 x	\	PRO1042
Ricambi / Spare Parts				
	schermo diffusore 200 cm. <i>diffuser 200 cm.</i>	1 x	opale bianco <i>opal white</i>	PRO1045

figura model	descrizione description	pezzi pieces	colore color	codice code	
 	profilo 200 cm. completo di diffusore opale <i>profile 200 cm. opal diffuser included</i>	1 x	profilo bianco diffusore opale bianco <i>profile white opal white diffuser</i>	PRO2120	
	Accessori / Accessories				
	schermo trasparente 200 cm. <i>transparent louvre 200 cm.</i>		1 x	trasparente <i>transparent</i>	PRO2126
	tappi terminali in plastica <i>plastic end caps</i>		2 x	bianco <i>white</i>	PRO2127
	clips di fissaggio <i>fixing clips</i>		2 x	\	PRO2128
Ricambi / Spare Parts					
schermo diffusore 200 cm. <i>diffuser 200 cm.</i>		1 x	opale bianco <i>opal white</i>	PRO2125	

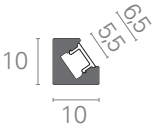
figura model	descrizione description	pezzi pieces	colore color	codice code	
 	profilo 200 cm. completo di diffusore opale <i>profile 200 cm. opal diffuser included</i>	1 x	profilo bianco diffusore opale bianco <i>profile white opal white diffuser</i>	PRO2110	
	Accessori / Accessories				
	schermo trasparente 200 cm. <i>transparent louvre 200 cm.</i>		1 x	trasparente <i>transparent</i>	PRO2116
	tappi terminali in plastica <i>plastic end caps</i>		2 x	bianco <i>white</i>	PRO2117
	Ricambi / Spare Parts				
schermo diffusore 200 cm. <i>diffuser 200 cm.</i>		1 x	opale bianco <i>opal white</i>	PRO2115	

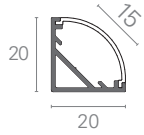
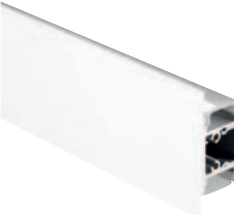
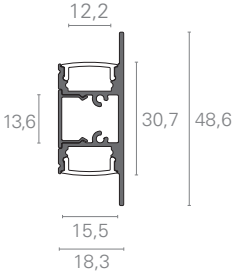
Profili da superficie

Profiles surface mounted

figura model	descrizione description	pezzi pieces	colore color	codice code	
	profilo 200 cm. completo di diffusore opale <i>profile 200 cm. opal diffuser included</i>	1 x	profilo bianco diffusore opale bianco <i>profile white opal white diffuser</i>	PRO2150	
	Accessori / Accessories				
	schermo trasparente 200 cm. <i>transparent louvre 200 cm.</i>	1 x	trasparente <i>transparent</i>	PRO2156	
	tappi terminali in plastica <i>plastic end caps</i>	2 x	bianco <i>white</i>	PRO2157	
	Alimentatore 220-240 V 24 VDC 100W <i>Driver 220-240 V 24 VDC 100W</i>	1 x		DRV2030	

Ricambi / Spare Parts

schermo diffusore 200 cm. <i>diffuser 200 cm.</i>	1 x	opale bianco <i>opal white</i>	PRO2155
--	-----	-----------------------------------	----------------

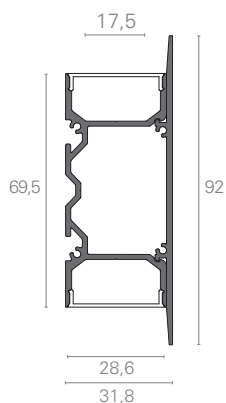

Installazione / Installation

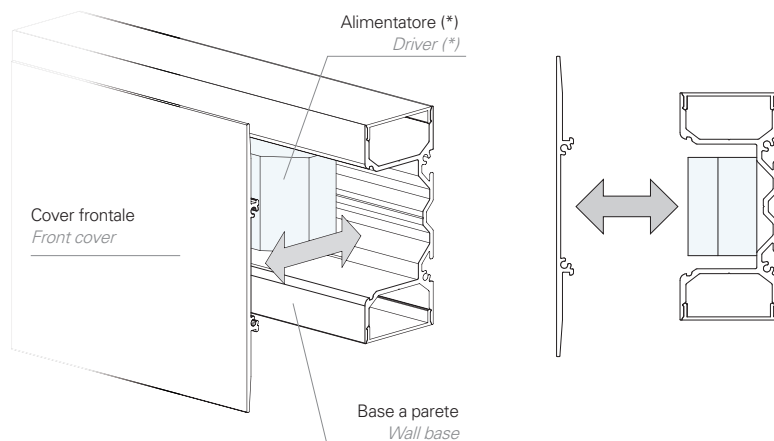

(*) Dimensioni massime dell'alimentatore: L=<1800; W= 30,5; H= 21,5
 (*) Driver max dimensions: L=<1800; W= 30,5; H= 21,5



Luce Lineare

Linear Light



Lybra
p.126

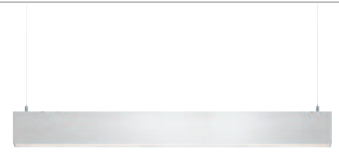

Karma
p.144



Segno Pendant
p.166



Segno Ceiling
p.172



Segno Wall
p.178



Segno Trimless
p.186



Steel Covers
p.190

Lybra

⊕ UP TO 123 lm / W CRI > 80 SDCM < 3

Sottile, minimale e performante; Lybra è la sospensione lineare dalle ridotte dimensioni progettata per illuminare uffici e ambienti commerciali. Disponibile nei due diversi colori bianco opaco e nero opaco, Lybra può essere equipaggiata con schermo per luce diffusa o con ottiche speculari UGR<19 per l'illuminazione delle postazioni di lavoro. Grazie alla sua biemissione bilanciata fra luce diffusa verso l'alto e luce diretta verso il basso, Lybra garantisce un effetto di luce morbida e confortevole in tutta l'area di interesse accentuando opportunamente la zona operativa.

Thin, minimal and performing; Lybra is a linear suspension with reduced dimensions designed for the lighting of offices and commercial environments. Available in two different colors matt white and matt black, Lybra can be equipped with a diffuser for diffused light effects or with UGR <19 specular optics for the lighting of workspaces. Thanks to its bi-emission balanced between diffused light upwards and directed light downwards, Lybra guarantees a soft and comfortable light effect throughout the area and lights correctly the visual task.

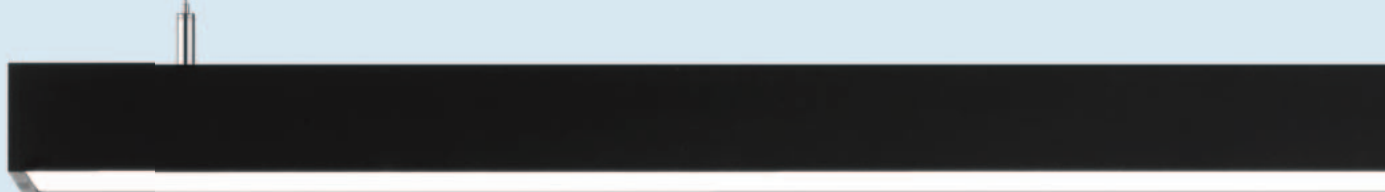

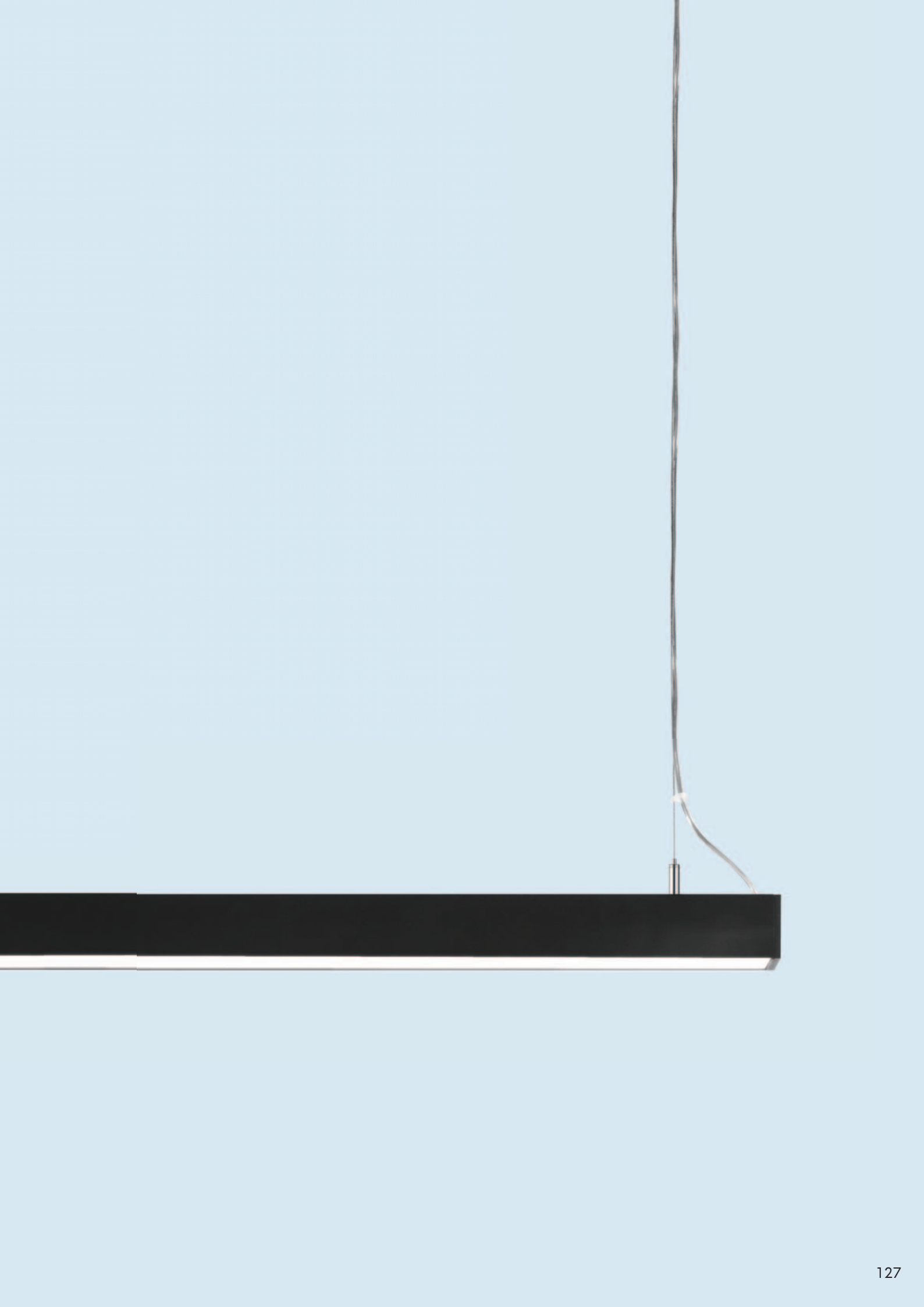

Diffuser



UGR < 19



Lybra è verniciata in bianco opaco o in nero opaco e ha i tappi in tinta con l'apparecchio. È equipaggiata con SMD Mid Power LED e Driver On/Off o DALI integrato nel rosone a soffitto. Tutta la componentistica elettronica è selezionata fra i prodotti delle più affidabili marche di elettronica.

Lybra is matt white or matt black painted and its caps matching the fixture finish. It's equipped with SMD Mid Power LED and On/Off or DALI driver integrated in the ceiling canopy. All electronic components are selected from the products of the most reliable electronic brands.

Cavi di sospensione da 1500 mm. con sistema di regolazione fine.

1500 mm. suspension cables with adjustment system.



Dimensioni / Dimensions

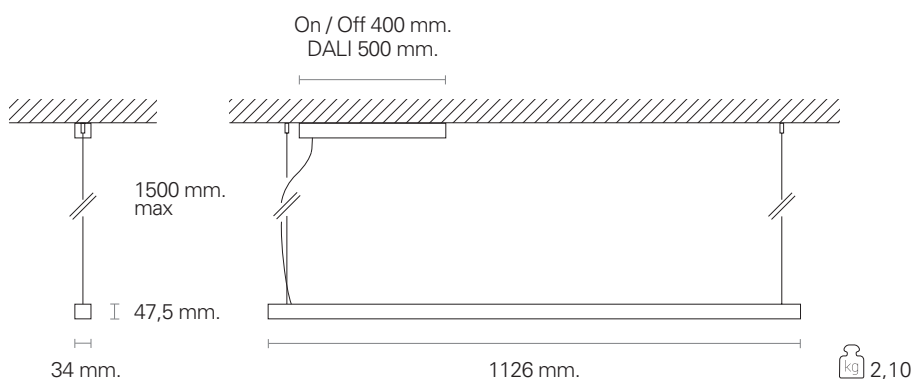

Ottiche / Optics

Diffuser 100° - 4000 K

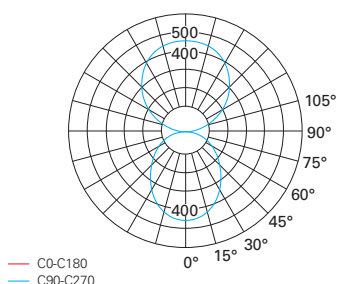

UGR < 19 / 38° - 4000 K

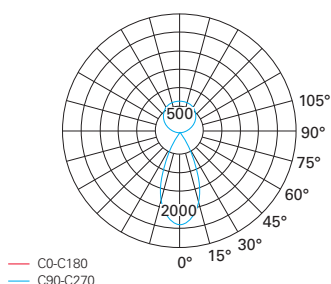

Lybra

CRI > 80

modello model	versione version	ottica optic	codice code	CCT CCT	flusso apparecchio lumen output		efficacia efficacy	CRI CRI	MacAdam SDCM	colore color
					downlight	uplight				
On/Off 220 ÷ 240 V singola accensione single switch	24+16 W	Diffuser 100°	LNR01011	3000K	2025 lm	1810 lm	96 lm/W	> 80	< 3	bianco / white
			LNR01012	3000K	2025 lm	1810 lm	96 lm/W	> 80	< 3	nero / black
			LNR01021	4000K	2200 lm	1950 lm	104 lm/W	> 80	< 3	bianco / white
			LNR01022	4000K	2200 lm	1950 lm	104 lm/W	> 80	< 3	nero / black
	20+20 W	UGR < 19 38°	LNR02011	3000K	2720 lm	1810 lm	113 lm/W	> 80	< 3	bianco / white
			LNR02012	3000K	2720 lm	1810 lm	113 lm/W	> 80	< 3	nero / black
			LNR02021	4000K	2960 lm	1950 lm	123 lm/W	> 80	< 3	bianco / white
			LNR02022	4000K	2960 lm	1950 lm	123 lm/W	> 80	< 3	nero / black
DALI 220 ÷ 240 V singola accensione single switch	24+16 W	Diffuser 100°	LNR01011DA	3000K	2025 lm	1810 lm	96 lm/W	> 80	< 3	bianco / white
			LNR01012DA	3000K	2025 lm	1810 lm	96 lm/W	> 80	< 3	nero / black
			LNR01021DA	4000K	2200 lm	1950 lm	104 lm/W	> 80	< 3	bianco / white
			LNR01022DA	4000K	2200 lm	1950 lm	104 lm/W	> 80	< 3	nero / black
	20+20 W	UGR < 19 38°	LNR02011DA	3000K	2720 lm	1810 lm	113 lm/W	> 80	< 3	bianco / white
			LNR02012DA	3000K	2720 lm	1810 lm	113 lm/W	> 80	< 3	nero / black
			LNR02021DA	4000K	2960 lm	1950 lm	123 lm/W	> 80	< 3	bianco / white
			LNR02022DA	4000K	2960 lm	1950 lm	123 lm/W	> 80	< 3	nero / black

Karma





Karma e Segno System sono realizzabili in finitura nero opaca su richiesta
Karma and Segno System can be supplied in matt black finish on request

Karma

design Daniele Monelli

Karma è un apparecchio per l'illuminazione degli ambienti indoor che garantisce elevate performance illuminotecniche in termini di efficacia luminosa, comfort visivo e affidabilità nel tempo.

Karma is a device for indoor lighting that guarantees high performance in terms of lighting efficacy, visual comfort and reliability over time.





Karma



UP TO
183 lm/W

CRI > 90

SDCM < 3



5 YEARS
WARRANTY

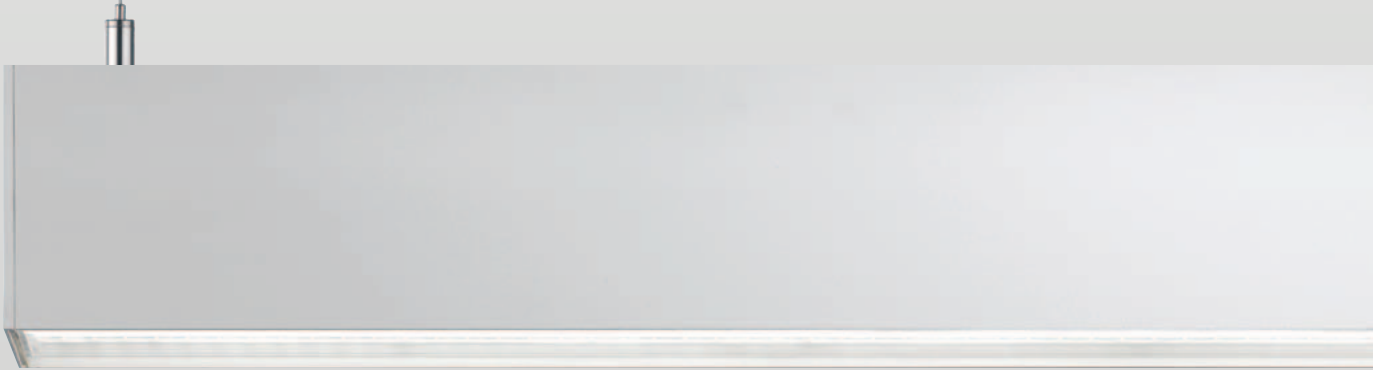



Karma Pendant pag. 146



Karma Ceiling pag. 148



Karma Wall pag. 150

Gli apparecchi Karma sono abbinabili ai rivestimenti in acciaio fotostampato del programma Steel Covers per personalizzare l'aspetto estetico degli apparecchi.

The Karma fixtures are suitable with the photoprinted steel coverings of the Steel Covers Program to customize the aesthetic appearance of the luminaires.



Pg. 190



Karma

Karma è realizzata in un unico pezzo di alluminio anodizzato, verniciato in colore bianco opaco; nelle diverse configurazioni può essere installata a sospensione, a plafone e a parete; è precablata e si installa rapidamente grazie ai connettori "fast plug" e alle sospensioni regolabili in altezza. È disponibile in diverse lunghezze, si completa con moduli ottici ad elevata efficienza già completi di lenti e schede led di ultima generazione. Karma è disponibile sia come downlighter sia come uplighter/downlighter. Le versioni a doppia emissione possono essere configurate sia in unica accensione che in doppia accensione.

Karma is made in a unique piece of anodised aluminum, painted in matt white; it is declined into different versions to be installed as a pendant, to ceiling or to wall. It is pre-wired and can be installed quickly thanks to the "fast plug" connectors and height-adjustable suspensions. It is available in different lengths; it is completed with high efficiency optical modules already equipped with lenses and latest generation LED boards. Karma is available as both a downlighter and an uplighter/downlighter. The double emission versions can be configured both in single ignition or in dual switching.



Singola o doppia emissione mono o dual switch

Single or dual emission by mono or dual switch

Karma è realizzato nelle versioni downlighter e downlighter / uplighter, sia in singola accensione che in doppia accensione.

Karma is available in the different versions of light emission, downlighter and downlighter / uplighter, with single ignition or dual switching.

Massima resa del colore

High color rendition

all'interno della gamma Karma sono disponibili moduli ottici con sorgenti led di prima selezione CRI > 90 / SDCM < 3

available versions equipped by prime label LED emitter CRI > 90 / SDCM < 3

Karma è fabbricato in Italia ed equipaggiato con elettroniche "European Prime Label", garantito 5 anni.

Karma is made in Italy ed equipped with "European Prime Label" electronic components, 5 years warranty.



5 YEARS
WARRANTY

Karma

Performance

Karma si distingue per l'elevata efficacia luminosa, il comfort visivo e l'affidabilità nel tempo, prestazioni che ne rendono ottimale l'applicazione in tutti gli ambienti indoor dove è richiesta luce lineare di qualità.

Karma is distinguished by its high luminous efficacy, visual comfort and reliability over time, making it ideal for application in all indoor projects where quality linear light is required.



Efficacy
fino a / up to
185 lm/W

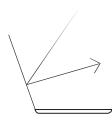

High Visual Comfort
fino a / up to
UGR < 19



Lifetime
L80-B20 / 80.000 h.



High Color Rendition
CRI > 90 / SDCM < 3



Compliance
EN 12464-1



Flicker Free
On-Off / Push / DALI /
Casambi / PAN Digital



5 Years
Warranty

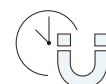

Smart Installation
Safe&Fast

Elegance

L'aspetto di Karma può essere personalizzato utilizzando gli accessori estetici della collezione "Steel Covers", specifiche lastre realizzate in acciaio inox che rivestono il corpo dell'apparecchio. Le Steel Covers si applicano senza attrezzi, sono removibili ed intercambiabili.

The appearance of Karma can be customized using the aesthetic accessories of the "Steel Covers" collection, consisting of specific slabs made of inox steel that cover the body of the appliance. The Steel Covers are assembled without tools, they are removable and interchangeable.



Cover estetiche in acciaio inox
applicabili senza utensili;
vedi pag. 190

*Aesthetic inox steel covers
no tools mounting;
see page 190*



Karma

Ottiche / *Optical Systems*

Luce Diffusa

Diffuse Light

Tutti i moduli ottici equipaggiati con schermo satinato diffondono la luce in modo uniforme per ottenere un'illuminazione morbida e priva di ombre eccessivamente marcate.

All the optical modules equipped with a diffusing satin screen the light evenly to obtain soft lighting without excessively strong shadows.

Simmetrica 90°

Symmetric 90°

I moduli ottici con lenti a 90° di apertura permettono di ottenere effetti di luce adatti ad illuminare ampie aree operative e zone espositive.

The optical modules symmetric 90° allow to obtain light effects suitable for illuminating large operational and exhibition areas.

Simmetrica 60°

Symmetric 60°

Grazie al loro elevato controllo dell'abbagliamento, i moduli ottici a 60° di apertura permettono di concentrare la luce sulle aree operative garantendo un valore di UGR < 19 e adeguati livelli di illuminamento sul piano di lavoro.

Thanks to their high glare control, the symmetric 60° optical modules allow to be concentrated the light on the operating areas while maintaining a ratio of UGR < 19 and ensuring the right levels of illumination on the work surface.

Asimmetrica

Asymmetric

I moduli con ottica asimmetrica sono ideati all'illuminazione dei piani verticali e particolarmente indicati per l'illuminazione di ampie pareti e di scaffalature.

The modules with asymmetric optics are suitable for vertical lighting and are particularly suitable for large walls lighting and shelving.

Doppia Asimmetrica

Dual Asymmetric

I moduli con ottica a doppia asimmetria illuminano i piani verticali verso entrambi i lati dell'apparecchio e sono particolarmente indicati per l'illuminazione dei corridoi, dei percorsi e delle corsie degli ambienti commerciali.

The modules with dual asymmetry optics illuminate the vertical planes towards both sides of the product and are particularly suitable for lighting corridors, paths and aisles in commercial environments.

Downlight

Downlight / Uplight

120°

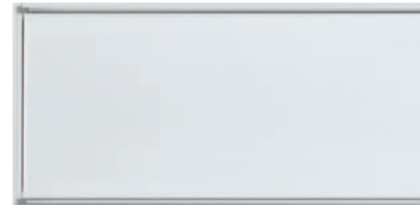
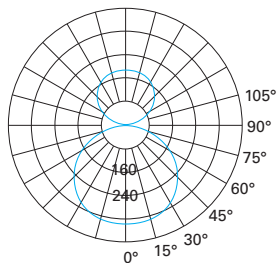
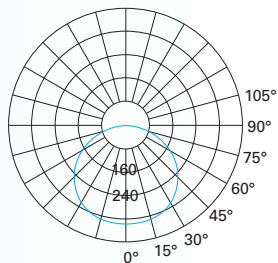

90°

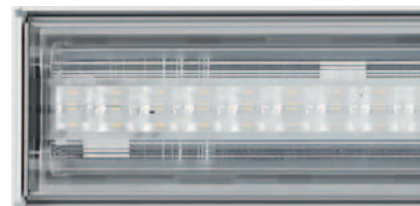
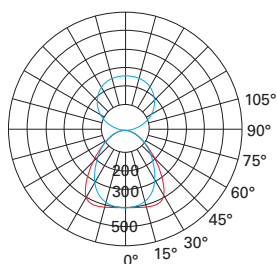
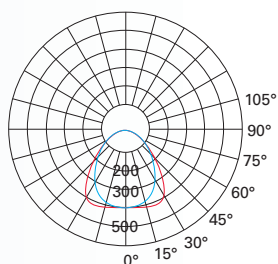

60°
UGR<19

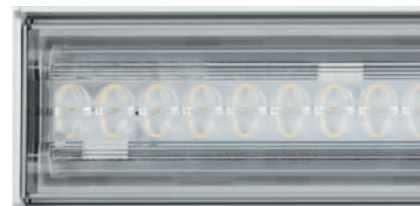
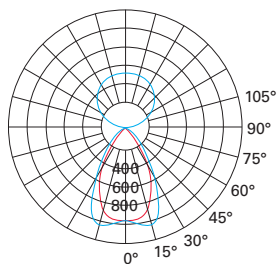
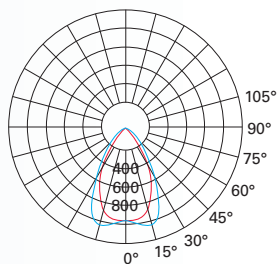

AS

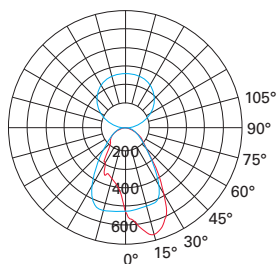
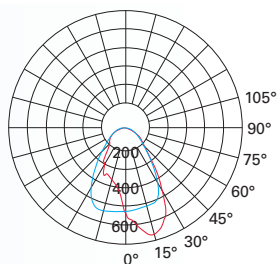

SY

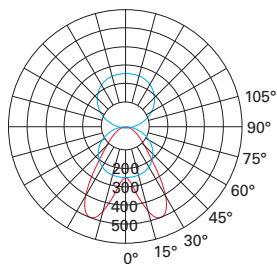
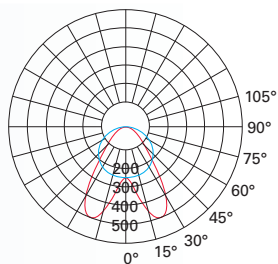

I moduli ottici di Karma Segno e Segno Trimless sono intercambiabili – vedi codici ricambi a pg. 61
The optic modules of Karma, Segno and Segno Trimless are interchangeable – see spare parts codes to pg. 61

Karma

Resa cromatica / *Color rendering*

CRI

R1 - R15

3000 K
CRI: 92,4

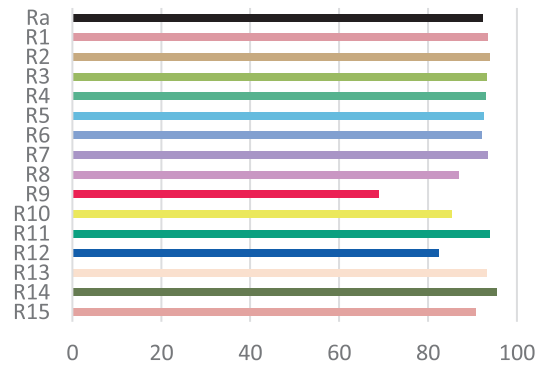
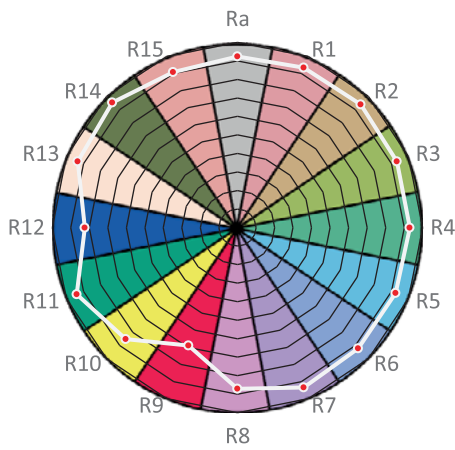

4000 K
CRI: 91,1

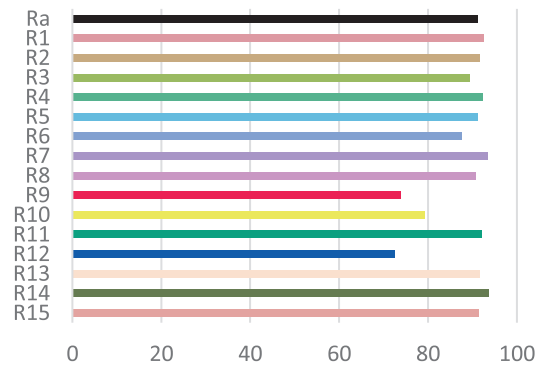
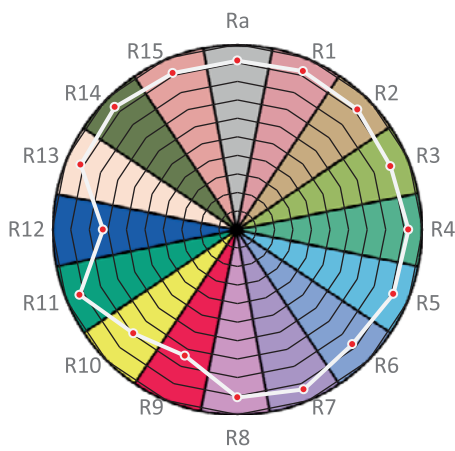

TM-30

Rf / Rg plot

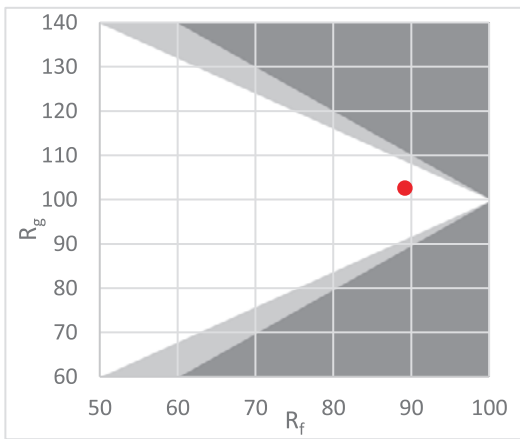

R_f 89,2
R_g 102,6

Color vector graphic

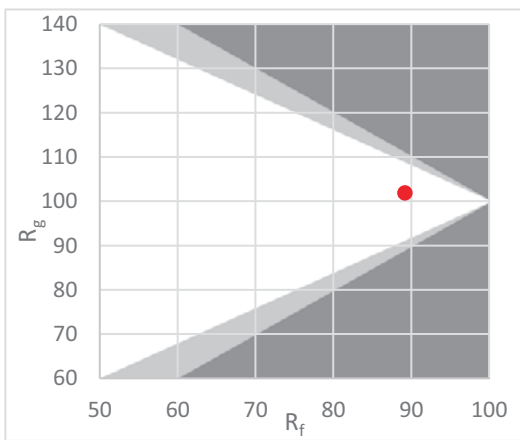
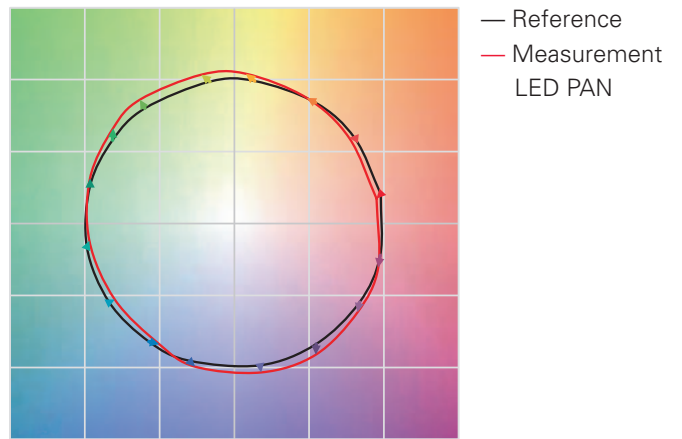

R_f 89,2
R_g 101,9

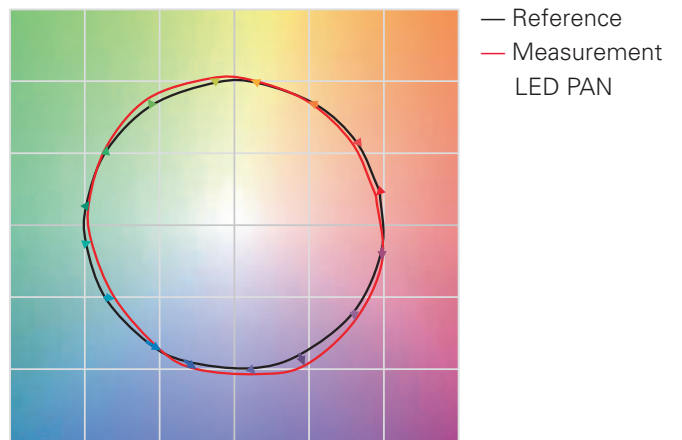

Karma

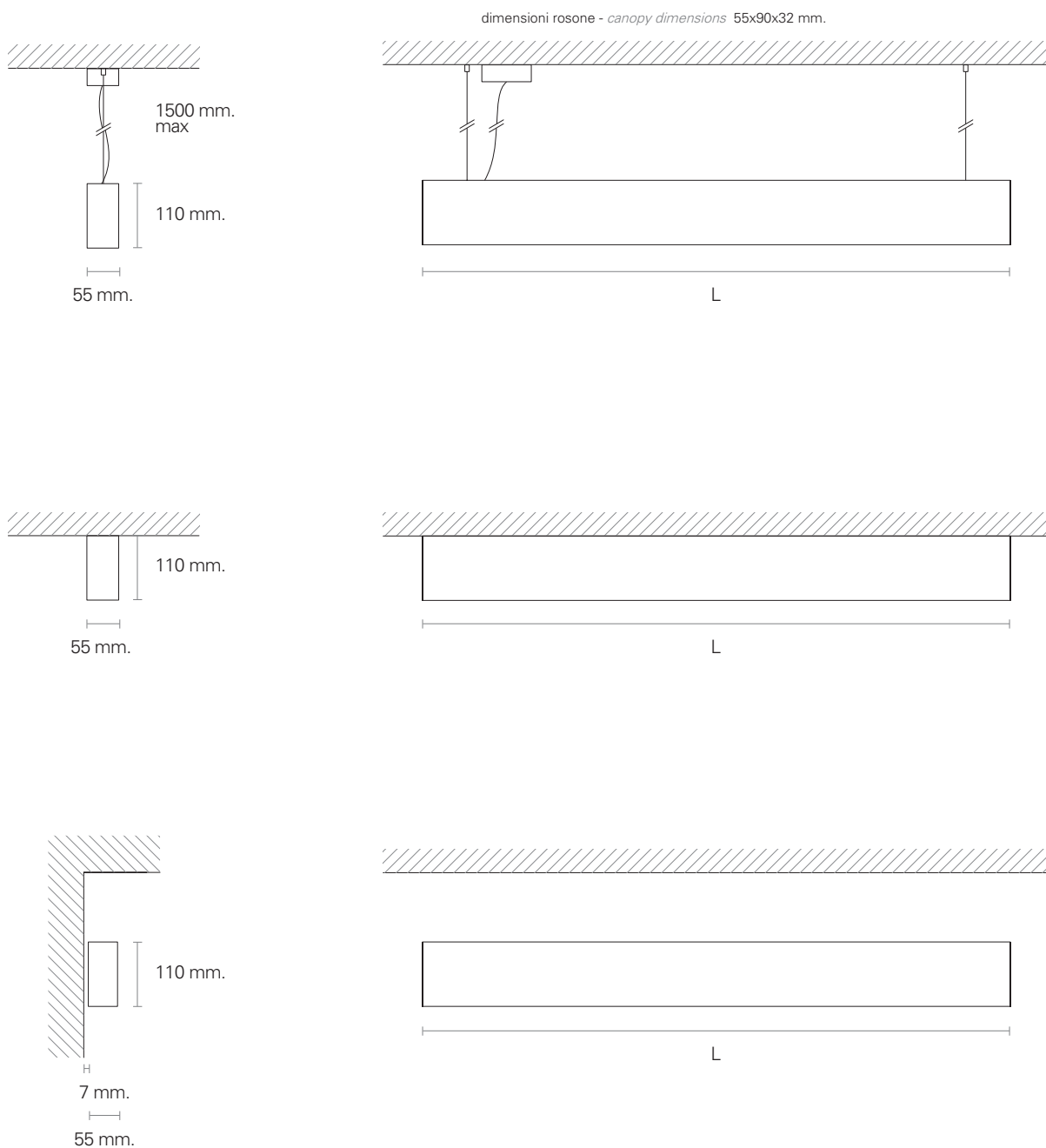

serie serie	versione version	L lunghezza - length		
		1140 mm.	1700 mm.	2260 mm.
Sospensione - Pendant	Downlight	5,4 kg.	7,7 kg.	10 kg.
	Downlight / Uplight	5,8 kg.	8,2 kg.	10,7 kg.
Plafone - Ceiling	Downlight	5,1 kg.	7,4 kg.	9,7 kg.
Parete - Wall	Downlight	5,1 kg.	7,4 kg.	9,7 kg.
	Downlight / Uplight	5,5 kg.	7,9 kg.	10,4 kg.



Karma Pendant

Sospensione Downlight - *Pendant Downlight*

CRI > 90

singola accensione - *single switch*

modello <i>model</i>	versione <i>version</i>	lunghezza <i>length</i>	ottica <i>optic</i>	codice <i>code</i>	CCT <i>CCT</i>	lumen output		efficacia <i>efficacy</i>	colore <i>colour</i>
						downlight	uplight		
On / Off 220 ÷ 240 V	24 W	1140 mm.	60° / UGR<19	ASD32410	3000 K	4260 lm	-	178 lm/W	bianco / <i>white</i>
			120°	ASD32510	4000 K	4400 lm	-	183 lm/W	bianco / <i>white</i>
		1700 mm.	60° / UGR<19	ASD32440	3000 K	3050 lm	-	127 lm/W	bianco / <i>white</i>
			120°	ASD32540	4000 K	3165 lm	-	132 lm/W	bianco / <i>white</i>
	36 W	1700 mm.	60° / UGR<19	ASD48410	3000 K	6395 lm	-	178 lm/W	bianco / <i>white</i>
			120°	ASD48510	4000 K	6600 lm	-	183 lm/W	bianco / <i>white</i>
		2260 mm.	60° / UGR<19	ASD48440	3000 K	4575 lm	-	127 lm/W	bianco / <i>white</i>
			120°	ASD48540	4000 K	4745 lm	-	132 lm/W	bianco / <i>white</i>
	48 W	2260 mm.	60° / UGR<19	ASD64410	3000 K	8520 lm	-	178 lm/W	bianco / <i>white</i>
			120°	ASD64510	4000 K	8800 lm	-	183 lm/W	bianco / <i>white</i>
		2260 mm.	60° / UGR<19	ASD64440	3000 K	6095 lm	-	127 lm/W	bianco / <i>white</i>
			120°	ASD64540	4000 K	6320 lm	-	132 lm/W	bianco / <i>white</i>

⊕ IP20 L80-B10 / 60.000 h.

Altre alimentazioni / *Other feedings*

Per ordinare Karma, nella versione Sospensione Downlight monoaccensione con alimentazioni alternative rispetto allo standard On/Off, aggiungere al codice standard la sigla riportata nella tabella a fianco.

To order Karma in single switch Pendant Downlight version differently feeded from standard On / Off model, add the abbreviation shown in the opposite table to the standard code.

Versioni in emergenza per Casambi e Pan Digital su richiesta. Contattare l'Azienda.

Emergency versions with Casambi or Pan Digital feeding on request. Take contact with the Company.

	versione <i>version</i>	DALI	Dimm. Push (*)	Emerg. 1 h	Casambi	Pan Digital
downlight single switch	24 W	DA	PU	\	CA	PD
	36 W	DA	PU	H1	CA	PD
	48 W	DA	PU	H1	CA	PD

(*) Massimo 4 moduli illuminanti. / (*) Up to 4 lighting modules.

Karma Pendant

Sospensione Uplight / Downlight - *Pendant Uplight / Downlight*

CRI > 90

singola accensione - *single switch*

modello <i>model</i>	versione <i>version</i>	lunghezza <i>length</i>	ottica <i>optic</i>	codice <i>code</i>	CCT <i>CCT</i>	lumen output		efficacia <i>efficacy</i>	colore <i>colour</i>
						downlight	uplight		
On / Off 220 ÷ 240 V	24+12 W	1140 mm.	60° / UGR<19	ASU47410	3000 K	4270 lm	1660 lm	165 lm/W	bianco / <i>white</i>
				ASU47510	4000 K	4420 lm	1715 lm	170 lm/W	bianco / <i>white</i>
		120°	ASU47440	3000 K	3060 lm	1800 lm	135 lm/W	bianco / <i>white</i>	
			ASU47540	4000 K	3170 lm	1865 lm	140 lm/W	bianco / <i>white</i>	
	36+12 W	1700 mm.	60° / UGR<19	ASU65410	3000 K	6365 lm	1660 lm	167 lm/W	bianco / <i>white</i>
				ASU65510	4000 K	6665 lm	1715 lm	175 lm/W	bianco / <i>white</i>
		120°	ASU65440	3000 K	4545 lm	1800 lm	132 lm/W	bianco / <i>white</i>	
			ASU65540	4000 K	4790 lm	1865 lm	139 lm/W	bianco / <i>white</i>	
	48+24 W	2260 mm.	60° / UGR<19	ASU98410	3000 K	8545 lm	3305 lm	165 lm/W	bianco / <i>white</i>
				ASU98510	4000 K	8840 lm	3425 lm	170 lm/W	bianco / <i>white</i>
		120°	ASU98440	3000 K	6125 lm	3590 lm	135 lm/W	bianco / <i>white</i>	
			ASU98540	4000 K	6330 lm	3720 lm	140 lm/W	bianco / <i>white</i>	

⊕ IP40 L80-B10 / 60.000 h.

Karma Pendant

Sospensione Uplight / Downlight - *Pendant Uplight / Downlight*

CRI > 90

doppia accensione - *dual switch*

modello <i>model</i>	versione <i>version</i>	lunghezza <i>length</i>	ottica <i>optic</i>	codice <i>code</i>	CCT <i>CCT</i>	lumen output		efficacia <i>efficacy</i>	colore <i>colour</i>
						downlight	uplight		
On / Off 220 ÷ 240 V	24+12 W	1140 mm.	60° / UGR<19	ASB47410	3000 K	4270 lm	1660 lm	165 lm/W	bianco / <i>white</i>
				ASB47510	4000 K	4420 lm	1715 lm	170 lm/W	bianco / <i>white</i>
		120°	ASB47440	3000 K	3060 lm	1800 lm	135 lm/W	bianco / <i>white</i>	
			ASB47540	4000 K	3170 lm	1865 lm	140 lm/W	bianco / <i>white</i>	
	36+12 W	1700 mm.	60° / UGR<19	ASB65410	3000 K	6365 lm	1660 lm	167 lm/W	bianco / <i>white</i>
				ASB65510	4000 K	6665 lm	1715 lm	175 lm/W	bianco / <i>white</i>
		120°	ASB65440	3000 K	4545 lm	1800 lm	132 lm/W	bianco / <i>white</i>	
			ASB65540	4000 K	4790 lm	1865 lm	139 lm/W	bianco / <i>white</i>	
	48+24 W	2260 mm.	60° / UGR<19	ASB98410	3000 K	8545 lm	3305 lm	165 lm/W	bianco / <i>white</i>
				ASB98510	4000 K	8840 lm	3425 lm	170 lm/W	bianco / <i>white</i>
		120°	ASB98440	3000 K	6125 lm	3590 lm	135 lm/W	bianco / <i>white</i>	
			ASB98540	4000 K	6330 lm	3720 lm	140 lm/W	bianco / <i>white</i>	

⊕ IP40 L80-B10 / 60.000 h.

Altre alimentazioni / *Other feedings*

Per ordinare Karma, nella versione Sospensione Uplight / Downlight monoaccensione con alimentazioni alternative rispetto allo standard On/Off, aggiungere al codice standard la sigla riportata nella tabella a fianco.

To order Karma in single switch Pendant Uplight / Downlight version differently feeded from standard On / Off model, add the abbreviation shown in the opposite table to the standard code.

Versioni in emergenza per Casambi e Pan Digital su richiesta. Contattare l'Azienda.

Emergency versions with Casambi or Pan Digital feeding on request. Take contact with the Company.

	versione <i>version</i>	DALI	Dimm. Push (*)	Emerg. 1 h	Casambi	Pan Digital
uplight / downlight single switch	24+12 W	DA	PU	\	CA	PD
	36+12 W	DA	PU	H1	CA	PD
	48+24 W	DA	PU	H1	CA	PD
uplight / downlight dual switch	24+12 W	\	\	\	\	\
	36+12 W	DA	PU	\	CA	PD
	48+24 W	DA	PU	\	CA	PD

(*) Massimo 4 moduli illuminanti. / (*) Up to 4 lighting modules.

Karma Ceiling

Plafoniera Downlight - *Ceiling Mounted Downlight*

CRI > 90

singola accensione - *single switch*

modello <i>model</i>	versione <i>version</i>	lunghezza <i>length</i>	ottica <i>optic</i>	codice <i>code</i>	CCT <i>CCT</i>	lumen output		efficacia <i>efficacy</i>	colore <i>colour</i>
						downlight	uplight		
On / Off 220 ÷ 240 V	24 W	1140 mm.	60° / UGR<19	ACD32410	3000 K	4260 lm	-	178 lm/W	bianco / <i>white</i>
			120°	ACD32510	4000 K	4400 lm	-	183 lm/W	bianco / <i>white</i>
		1700 mm.	60° / UGR<19	ACD32440	3000 K	3050 lm	-	127 lm/W	bianco / <i>white</i>
			120°	ACD32540	4000 K	3165 lm	-	132 lm/W	bianco / <i>white</i>
	36 W	1700 mm.	60° / UGR<19	ACD48410	3000 K	6395 lm	-	178 lm/W	bianco / <i>white</i>
			120°	ACD48510	4000 K	6600 lm	-	183 lm/W	bianco / <i>white</i>
		2260 mm.	60° / UGR<19	ACD48440	3000 K	4575 lm	-	127 lm/W	bianco / <i>white</i>
			120°	ACD48540	4000 K	4745 lm	-	132 lm/W	bianco / <i>white</i>
	48 W	2260 mm.	60° / UGR<19	ACD64410	3000 K	8520 lm	-	178 lm/W	bianco / <i>white</i>
			120°	ACD64510	4000 K	8800 lm	-	183 lm/W	bianco / <i>white</i>
		2260 mm.	60° / UGR<19	ACD64440	3000 K	6095 lm	-	127 lm/W	bianco / <i>white</i>
			120°	ACD64540	4000 K	6320 lm	-	132 lm/W	bianco / <i>white</i>

⊕ IP20 L80-B10 / 60.000 h.

Altre alimentazioni / *Other feedings*

Per ordinare Karma, nella versione Plafoniera Downlight monoaccensione con alimentazioni alternative rispetto allo standard On/Off, aggiungere al codice standard la sigla riportata nella tabella a fianco.
To order Karma in single switch Ceiling Downlight version differently feeded from standard On / Off model, add the abbreviation shown in the opposite table to the standard code.

Versions in emergenza per Casambi e Pan Digital su richiesta. Contattare l'Azienda.

Emergency versions with Casambi or Pan Digital feeding on request. Take contact with the Company.

	versione <i>version</i>	DALI	Dimm. Push (*)	Emerg. 1 h	Casambi	Pan Digital
downlight single switch	24 W	DA	PU	\	CA	PD
	36 W	DA	PU	H1	CA	PD
	48 W	DA	PU	H1	CA	PD

(*) Massimo 4 moduli illuminanti. / (*) Up to 4 lighting modules.



Karma e Segno System sono realizzabili in finitura nero opaca su richiesta
Karma and Segno System can be supplied in matt black finish on request

Karma Wall

Parete Downlight - Wall Mounted Downlight

CRI > 90

singola accensione - *single switch*

modello model	versione version	lunghezza length	ottica optic	codice code	CCT CCT	lumen output		efficacia efficacy	colore colour
						downlight	uplight		
On / Off 220 ÷ 240 V	24 W	1140 mm.	120°	AWD32440	3000 K	3050 lm	-	127 lm/W	bianco / <i>white</i>
				AWD32540	4000 K	3165 lm	-	132 lm/W	bianco / <i>white</i>
			AS	AWD32450	3000 K	4185 lm	-	174 lm/W	bianco / <i>white</i>
				AWD32550	4000 K	4320 lm	-	180 lm/W	bianco / <i>white</i>
	36 W	1700 mm.	120°	AWD48440	3000 K	4575 lm	-	127 lm/W	bianco / <i>white</i>
				AWD48540	4000 K	4745 lm	-	132 lm/W	bianco / <i>white</i>
			AS	AWD48450	3000 K	6270 lm	-	174 lm/W	bianco / <i>white</i>
				AWD48550	4000 K	6470 lm	-	180 lm/W	bianco / <i>white</i>
	48 W	2260 mm.	120°	AWD64440	3000 K	6095 lm	-	127 lm/W	bianco / <i>white</i>
				AWD64540	4000 K	6320 lm	-	132 lm/W	bianco / <i>white</i>
			AS	AWD64450	3000 K	8360 lm	-	174 lm/W	bianco / <i>white</i>
				AWD64550	4000 K	8630 lm	-	180 lm/W	bianco / <i>white</i>

⊕ IP20 L80-B10 / 60.000 h.

Altre alimentazioni / Other feedings

Per ordinare Karma, nella versione Parete Downlight monoaccensione con alimentazioni alternative rispetto allo standard On/Off, aggiungere al codice standard la sigla riportata nella tabella a fianco.

To order Karma in single switch Wall Mounted Downlight version differently feeded from standard On / Off model, add the abbreviation shown in the opposite table to the standard code.

Versioni in emergenza per Casambi e Pan Digital su richiesta. Contattare l'Azienda.

Emergency versions with Casambi or Pan Digital feeding on request. Take contact with the Company.

	versione version	DALI	Dimm. Push (*)	Emerg. 1 h	Casambi	Pan Digital
downlight single switch	24 W	DA	PU	\	CA	PD
	36 W	DA	PU	H1	CA	PD
	48 W	DA	PU	H1	CA	PD

(*) Massimo 4 moduli illuminanti. / (*) Up to 4 lighting modules.

Karma Wall

Parete Uplight / Downlight - Wall Mounted Uplight / Downlight

CRI > 90

singola accensione - single switch

modello model	versione version	lunghezza length	ottica optic	codice code	CCT CCT	lumen output		efficacia efficacy	colore colour
						downlight	uplight		
On / Off 220 ÷ 240 V	24+12 W	1140 mm.	120°	AWU47440	3000 K	3060 lm	1800 lm	135 lm/W	bianco / white
				AWU47540	4000 K	3170 lm	1865 lm	140 lm/W	bianco / white
			AS	AWU47450	3000 K	4190 lm	1630 lm	162 lm/W	bianco / white
				AWU47550	4000 K	4340 lm	1680 lm	167 lm/W	bianco / white
	36+12 W	1700 mm.	120°	AWU65440	3000 K	4545 lm	1800 lm	132 lm/W	bianco / white
				AWU65540	4000 K	4790 lm	1865 lm	139 lm/W	bianco / white
			AS	AWU65450	3000 K	6240 lm	1630 lm	164 lm/W	bianco / white
				AWU65550	4000 K	6535 lm	1680 lm	171 lm/W	bianco / white
	48+24 W	2260 mm.	120°	AWU98440	3000 K	6125 lm	3590 lm	135 lm/W	bianco / white
				AWU98540	4000 K	6330 lm	3720 lm	140 lm/W	bianco / white
			AS	AWU98450	3000 K	8380 lm	3240 lm	161 lm/W	bianco / white
				AWU98550	4000 K	8670 lm	3355 lm	167 lm/W	bianco / white

⊕ IP40 L80-B10 / 60.000 h.

Karma Wall

Parete Uplight / Downlight - Wall Mounted Uplight / Downlight

CRI > 90

doppia accensione - dual switch

modello model	versione version	lunghezza length	ottica optic	codice code	CCT CCT	lumen output		efficacia efficacy	colore colour
						downlight	uplight		
On / Off 220 ÷ 240 V	24+12 W	1140 mm.	120°	AWB47440	3000 K	3060 lm	1800 lm	135 lm/W	bianco / white
				AWB47540	4000 K	3170 lm	1865 lm	140 lm/W	bianco / white
			AS	AWB47450	3000 K	4190 lm	1630 lm	162 lm/W	bianco / white
				AWB47550	4000 K	4340 lm	1680 lm	167 lm/W	bianco / white
	36+12 W	1700 mm.	120°	AWB65440	3000 K	4545 lm	1800 lm	132 lm/W	bianco / white
				AWB65540	4000 K	4790 lm	1865 lm	139 lm/W	bianco / white
			AS	AWB65450	3000 K	6240 lm	1630 lm	164 lm/W	bianco / white
				AWB65550	4000 K	6535 lm	1680 lm	171 lm/W	bianco / white
	48+24 W	2260 mm.	120°	AWB98440	3000 K	6125 lm	3590 lm	135 lm/W	bianco / white
				AWB98540	4000 K	6330 lm	3720 lm	140 lm/W	bianco / white
			AS	AWB98450	3000 K	8380 lm	3240 lm	161 lm/W	bianco / white
				AWB98550	4000 K	8670 lm	3355 lm	167 lm/W	bianco / white

⊕ IP40 L80-B10 / 60.000 h.

Altre alimentazioni / Other feedings

Per ordinare Karma, nella versione Parete Uplight / Downlight monoaccensione con alimentazioni alternative rispetto allo standard On/Off, aggiungere al codice standard la sigla riportata nella tabella a fianco.

To order Karma in single switch Wall Mounted Uplight / Downlight version differently feeded from standard On / Off model, add the abbreviation shown in the opposite table to the standard code.

Versioni in emergenza per Casambi e Pan Digital su richiesta. Contattare l'Azienda.

Emergency versions with Casambi or Pan Digital feeding on request. Take contact with the Company.

	versione version	DALI	Dimm. Push (*)	Emerg. 1 h	Casambi	Pan Digital
downlight single switch	24+12 W	DA	PU	\	CA	PD
	36+12 W	DA	PU	H1	CA	PD
	48+24 W	DA	PU	H1	CA	PD
uplight / downlight dual switch	24+12 W	\	\	\	\	\
	36+12 W	DA	PU	\	CA	PD
	48+24 W	DA	PU	\	CA	PD

(*) Massimo 4 moduli illuminanti. / (*) Up to 4 lighting modules.

Segno System

design Daniele Monelli

Il sistema Segno permette di realizzare effetti di luce lineare senza interruzioni. È progettato nelle diverse configurazioni per l'installazione a plafone, a parete, a sospensione e ad incasso trimless. Si compone di moduli illuminanti da completare con gli appositi accessori di montaggio, in funzione del tipo di installazione che si vuole realizzare. L'installazione dei moduli illuminanti in linea continua si realizza grazie ai particolari giunti meccanici "Junction Driven" che assicurano una miglior precisione nell'allineamento delle barre. I moduli illuminanti sono precablati e possono essere equipaggiati con diversi sistemi di alimentazione, consentendo la piena compatibilità con tutti gli impianti elettrici. I moduli illuminanti sono già completi di moduli ottici (ottiche e schede led) a fissaggio magnetico, e il collegamento avviene grazie a plug di connessione rapida. I moduli ottici sono preassemblati e proteggono i led da ogni possibile contatto accidentale anche durante la fase di installazione.

Segno System allow to create linear lighting effects without breaks. It is designed in different configuration to different ceiling, pendant, wall, trimless recessed mounting. It is composed by lighting modules which must be completed with the appropriate mounting accessories as a function of the type of installation to be carried out. The installation of the lighting modules in a continuous line is achieved thanks to the special mechanical joints "Junction Driven" which ensure better precision in the alignment of the bars. The lighting modules are pre-wired and can be equipped with different power systems, allowing full compatibility with all electrical systems. The lighting modules are already complete with optics modules (lenses+led) which are fixed by magnets, and the connection is made thanks to a quick connection plug. The optical modules are preassembled and protect the LEDs from any possible accidental contact even during the installation.

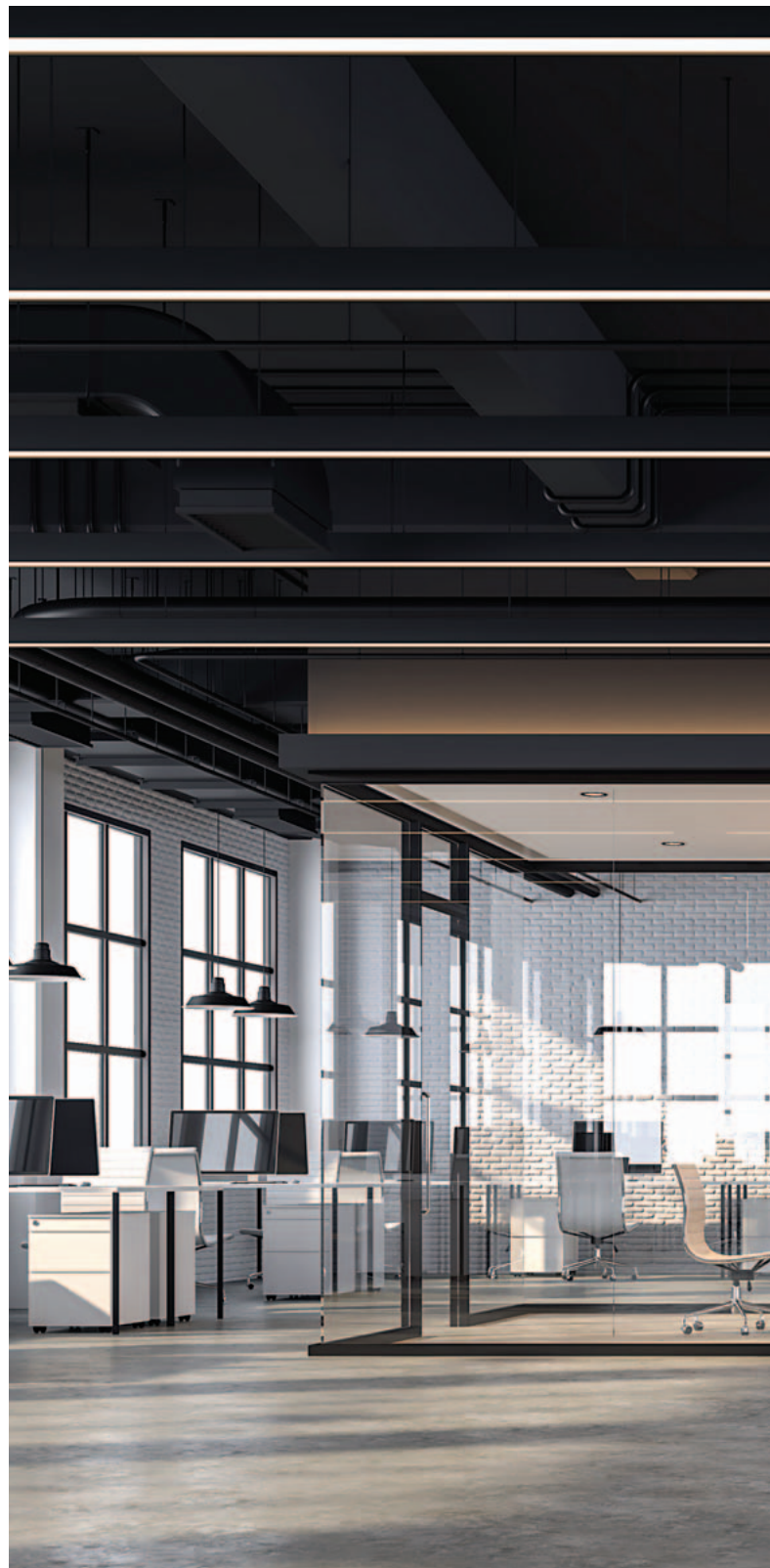



Segno System



UP TO
183 lm/W

CRI > 90

SDCM < 3



5 YEARS
WARRANTY



Segno Pendant pag. 166



Segno Ceiling pag. 172



Segno Wall pag. 178



Segno Trimless pag. 188

I moduli di Segno System sono abbinabili ai rivestimenti in acciaio fotostampato del programma Steel Covers per personalizzare l'aspetto estetico degli apparecchi.

All Segno System modules are suitable with the photoprinted steel coverings of the Steel Covers Program to customize the aesthetic appearance of the luminaires.



Pg. 190

Segno System

Segno System consente svariate possibilità di configurare l'illuminazione dell'ambiente grazie ai diversi sistemi ottici che li equipaggiano. Si installa a sospensione, a soffitto ed a parete. Segno Trimless completa le possibilità installative con la versione ad incasso nel cartongesso senza bordo a vista.

Segno System allow various possibilities for configuring the lighting of the ambient thanks to the different optical systems. The types of installation are pendant, ceiling and wall. Segno Trimless completes the installation possibilities with the recessed version in plasterboard trimless.

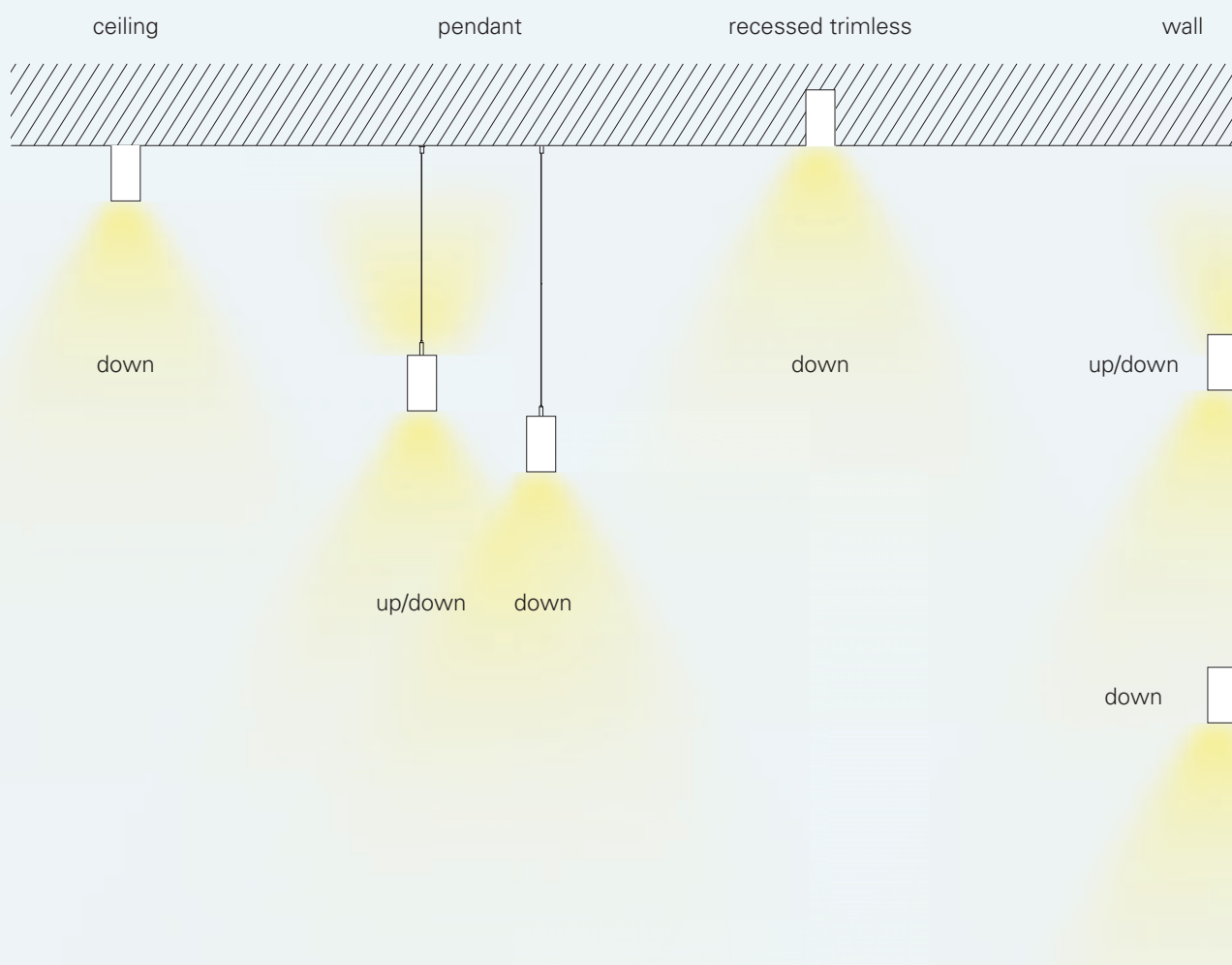

L'emissione luminosa dei moduli ottici di Segno può essere di tipo "downlight" oppure "downlight / uplight". Cinque diverse ottiche possono caratterizzare l'emissione diretta verso il basso per soddisfare tutte le esigenze illuminotecniche. Le versioni "downlight / uplight" sono disponibili sia in accensione singola che in doppia accensione.

The light emission of Segno optic modules can be "downlight" or "downlight / uplight". Five different optics characterize the direct downward emission to satisfy any lighting requirements. The "downlight / uplight" versions are available in both single ignition or dual switching.

Schemi di cablaggio / Wiring diagrams

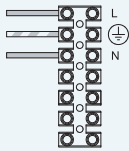
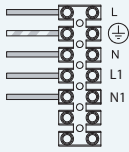
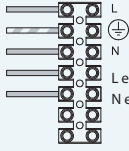
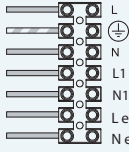
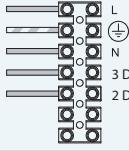
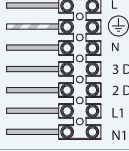
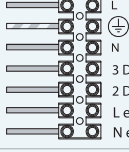
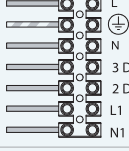
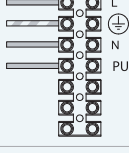
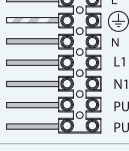
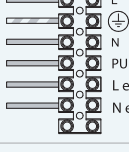
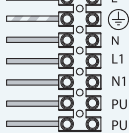
On / Off	<p>singola accensione single switch</p> 	<p>singolo rosone completo di cavo 3x 1,5 mm² colore bianco</p>	<p>single canopy wired with 3x 1,5 mm² cable white color</p>
	<p>doppia accensione dual switch</p> 	<p>singolo rosone completo di cavo 5x 1,5 mm² colore bianco</p>	<p>single canopy wired with 5x 1,5 mm² cable white color</p>
	<p>singola accensione + emergenza 1 h. single switch + emergency 1 h.</p> 	<p>singolo rosone completo di cavo 5x 1,5 mm² colore bianco</p>	<p>single canopy wired with 5x 1,5 mm² cable white color</p>
	<p>doppia accensione + emergenza 1 h. dual switch + emergency 1 h.</p> 	<p>doppio rosone 1x completo di cavo 5x 1,5 mm² 1x completo di cavo 3x 1,5 mm² colore bianco</p>	<p>dual canopies 1x wired with 5x 1,5 mm² cable 1x wired with 3x 1,5 mm² cable white color</p>
DALI	<p>singola accensione single switch</p> 	<p>singolo rosone completo di cavo 5x 1,5 mm² colore bianco</p>	<p>single canopy wired with 5x 1,5 mm² cable white color</p>
	<p>doppia accensione dual switch</p> 	<p>doppio rosone 1x completo di cavo 5x 1,5 mm² 1x completo di cavo 3x 1,5 mm² colore bianco</p>	<p>dual canopies 1x wired with 5x 1,5 mm² cable 1x wired with 3x 1,5 mm² cable white color</p>
	<p>singola accensione + emergenza 1 h. single switch + emergency 1 h.</p> 	<p>doppio rosone 1x completo di cavo 5x 1,5 mm² 1x completo di cavo 3x 1,5 mm² colore bianco</p>	<p>dual canopies 1x wired with 5x 1,5 mm² cable 1x wired with 3x 1,5 mm² cable white color</p>
	<p>doppia accensione + emergenza 1 h. dual switch + emergency 1 h.</p> 	<p>doppio rosone 2x completi di cavo 5x 1,5 mm² colore bianco</p>	<p>dual canopies both wired with 5x 1,5 mm² cable white color</p>
PUSH	<p>singola accensione single switch</p> 	<p>singolo rosone completo di cavo 5x 1,5 mm² colore bianco</p>	<p>single canopy wired with 5x 1,5 mm² cable white color</p>
	<p>doppia accensione dual switch</p> 	<p>doppio rosone 2x completi di cavo 5x 1,5 mm² colore bianco</p>	<p>dual canopies both wired with 5x 1,5 mm² cable white color</p>
	<p>singola accensione + emergenza 1 h. single switch + emergency 1 h.</p> 	<p>doppio rosone 1x completo di cavo 5x 1,5 mm² 1x completo di cavo 3x 1,5 mm² colore bianco</p>	<p>dual canopies 1x wired with 5x 1,5 mm² cable 1x wired with 3x 1,5 mm² cable white color</p>
	<p>doppia accensione + emergenza 1 h. dual switch + emergency 1 h.</p> 	<p>doppio rosone 1x completo di cavo 5x 1,5 mm² 1x completo di cavo 3x 1,5 mm² colore bianco</p>	<p>dual canopies 1x wired with 5x 1,5 mm² cable 1x wired with 3x 1,5 mm² cable white color</p>

Segno System

Ottiche / *Optical Systems*

Luce Diffusa

Diffuse Light

Tutti i moduli ottici equipaggiati con schermo satinato diffondono la luce in modo uniforme per ottenere un'illuminazione morbida e priva di ombre eccessivamente marcate.

All the optical modules equipped with a diffusing satin screen the light evenly to obtain soft lighting without excessively strong shadows.

Simmetrica 90°

Symmetric 90°

I moduli ottici con lenti a 90° di apertura permettono di ottenere effetti di luce adatti ad illuminare ampie aree operative e zone espositive.

The optical modules symmetric 90° allow to obtain light effects suitable for illuminating large operational and exhibition areas.

Simmetrica 60°

Symmetric 60°

Grazie al loro elevato controllo dell'abbagliamento, i moduli ottici a 60° di apertura permettono di concentrare la luce sulle aree operative garantendo un valore di UGR<19 e adeguati livelli di illuminamento sul piano di lavoro.

Thanks to their high glare control, the symmetric 60° optical modules allow to be concentrated the light on the operating areas while maintaining a ratio of UGR <19 and ensuring the right levels of illumination on the work surface.

Asimmetrica

Asymmetric

I moduli con ottica asimmetrica sono ideati all'illuminazione dei piani verticali e particolarmente indicati per l'illuminazione di ampie pareti e di scaffalature.

The modules with asymmetric optics are suitable for vertical lighting and are particularly suitable for large walls lighting and shelving.

Doppia Asimmetrica

Dual Asymmetric

I moduli con ottica a doppia asimmetria illuminano i piani verticali verso entrambi i lati dell'apparecchio e sono particolarmente indicati per l'illuminazione dei corridoi, dei percorsi e delle corsie degli ambienti commerciali.

The modules with dual asymmetry optics illuminate the vertical planes towards both sides of the product and are particularly suitable for lighting corridors, paths and aisles in commercial environments.

Downlight

Downlight / Uplight

120°

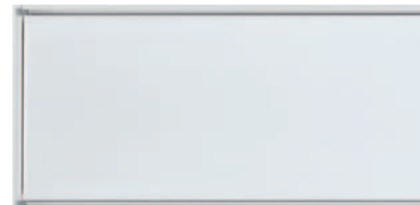
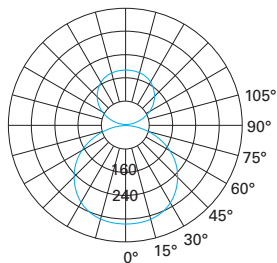
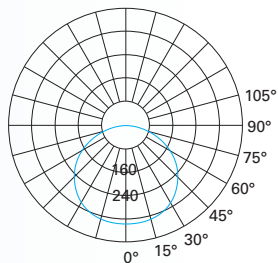

90°

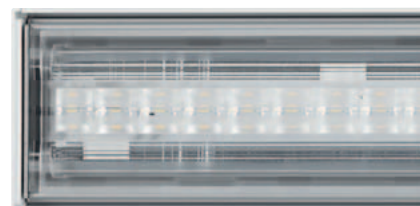
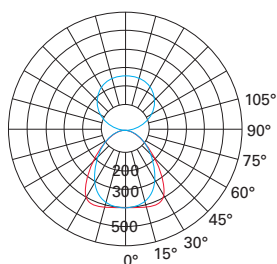
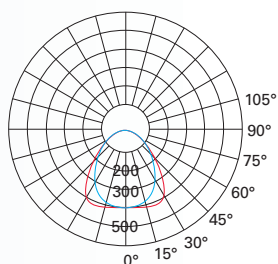

60°
UGR<19

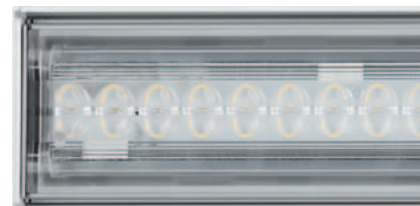
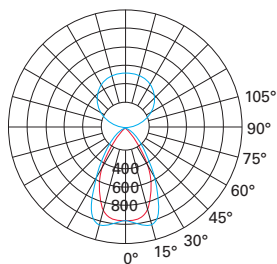
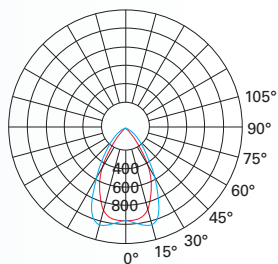

AS

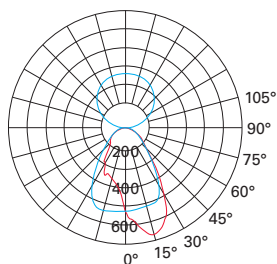
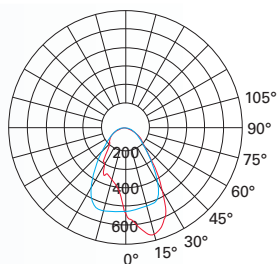

SY

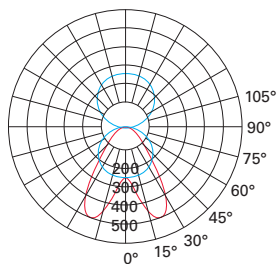
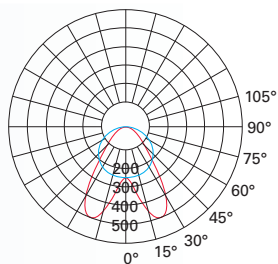

I moduli ottici di Karma Segno e Segno Trimless sono intercambiabili – vedi codici ricambi a pg. 61
The optic modules of Karma, Segno and Segno Trimless are interchangeable – see spare parts codes to pg. 61

Segno System

Resa cromatica / *Color rendering*

CRI

R1 - R15

3000 K
CRI: 92,4

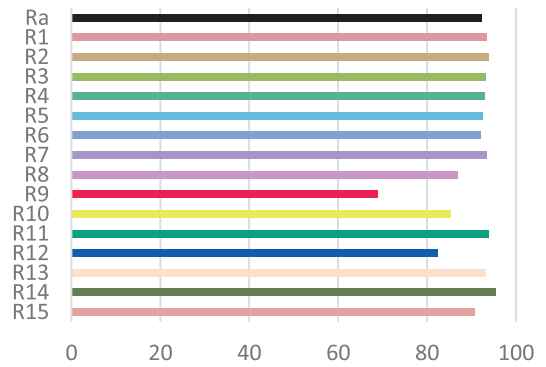
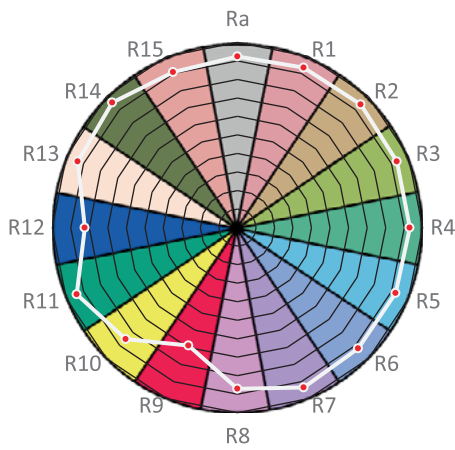

4000 K
CRI: 91,1

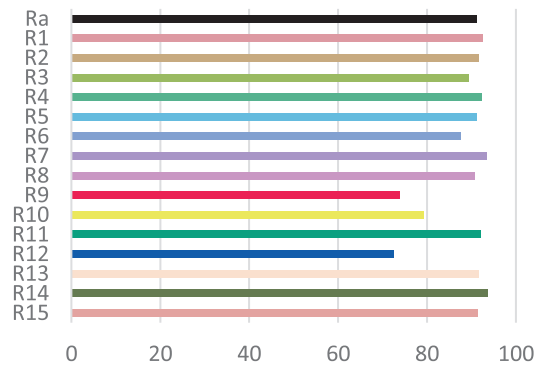
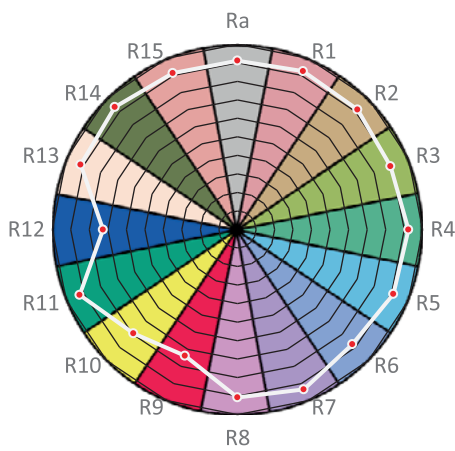

TM-30

Rf / Rg plot

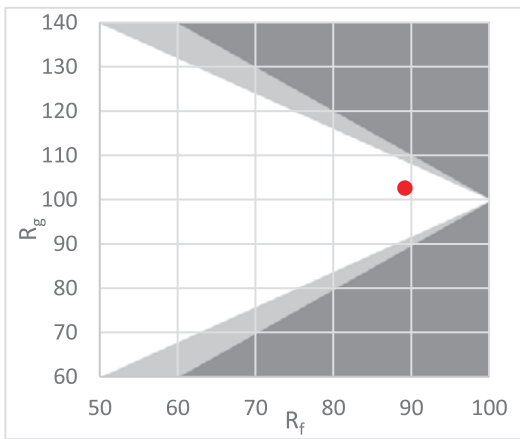

R_f 89,2
R_g 102,6

Color vector graphic

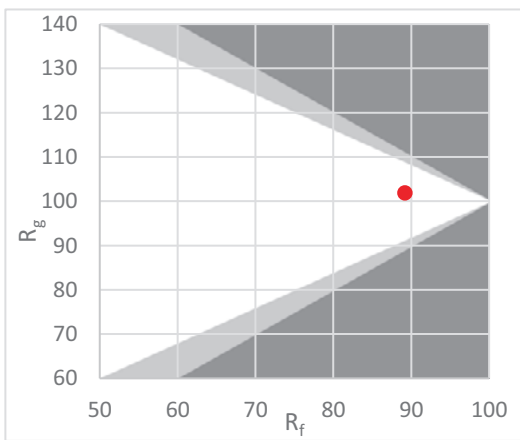
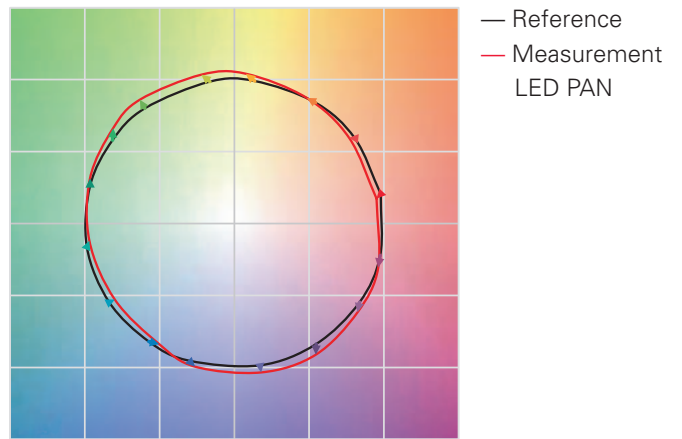

R_f 89,2
R_g 101,9

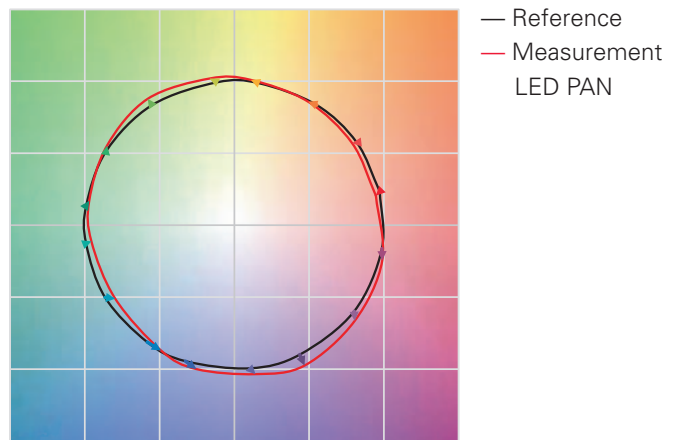

Segno Pendant / Ceiling / Wall

design Daniele Monelli

Segno è un sistema modulare per file di luce continua senza interruzioni. Essenziale nel design, si presta a numerose applicazioni integrandosi perfettamente in ogni contesto architettonico.

Segno is a modular system for continuous light lines with no discontinuance. Essential in design, suitable for every application, integrating perfectly in all architectural projects.





Segno Pendant / Ceiling / Wall

Installazione - *installation*

Segno si installa in fila continua grazie al particolare giunto meccanico che, grazie alle sue viti di regolazione, permette di allineare perfettamente i singoli moduli strutturali. Agendo sulle viti di regolazione dei giunti meccanici si allineano i moduli strutturali fra loro, ottenendo così una migliore installazione. Gli appositi fast-plug garantiscono la connessione elettrica fra i moduli strutturali precablati senza bisogno di utilizzare utensili.

Segno can be installed in a continuous line thanks to the mechanic joint that, thanks to its adjustment screws, allows the individual rail modules to be perfectly aligned. Acting on the adjustment screws of the mechanical joints and aligning the rail modules together, thus obtaining a better installation. The special fast-plugs require the electrical connection between pre-wired modules without tools.

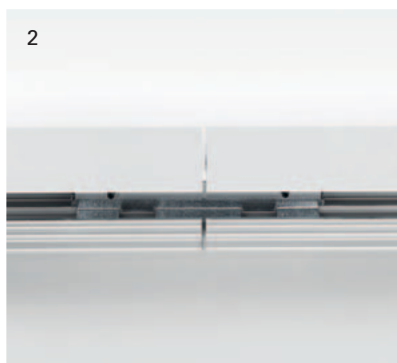
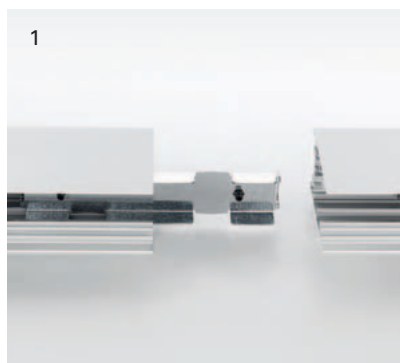

1 - Inserimento del giunto meccanico fra i moduli strutturali
Inserting mechanical joint between the rail modules

2 - Accoppiamento dei moduli strutturali
Matching of rail modules

3 - Fissaggio e allineamento dei moduli strutturali grazie alle apposite viti di regolazione
Fixing and alignment of the rail modules thanks to the appropriate adjustment screws

- Cavo di sospensione in acciaio e regolazione dell'altezza di sospensione con sistema "grip-lock".
Adjustable steel pendant with "grip-lock" system.

- Il "nipple" è posizionato sulla parte superiore dell'apparecchio anziché a soffitto per facilitare la fase regolazione.
The suspension nipple is located on the luminaire instead of the ceiling in order to make easy the height regulation.

- La portata massima di ogni kit di sospensione è di 12kg.
Each pendant kit is max. 12kg strength.



L'installazione di Segno è rapida, semplice ed intuitiva; una volta fissati a soffitto i moduli strutturali già precablati, si montano i moduli ottici con un semplice click grazie al sistema di fissaggio magnetico incorporato. Il collegamento elettrico dei moduli ottici è in bassissima tensione e avviene senza utensili grazie all'apposito "fast plug". Il sistema di regolazione della lunghezza del cavo di sospensione è facilmente accessibile perché collocato direttamente sul modulo strutturale.

The installation of Segno is quick, simple and intuitive; once the pre-wired rail modules are fixed to the wall, the optical modules are mounted with a simple click thanks to the built-in magnetic fixing system. The electrical connection of the optical modules is in very low voltage and without tools thanks to the special "fast plug". The suspension cable length adjustment system is easily accessible because it is placed directly on the rail module.

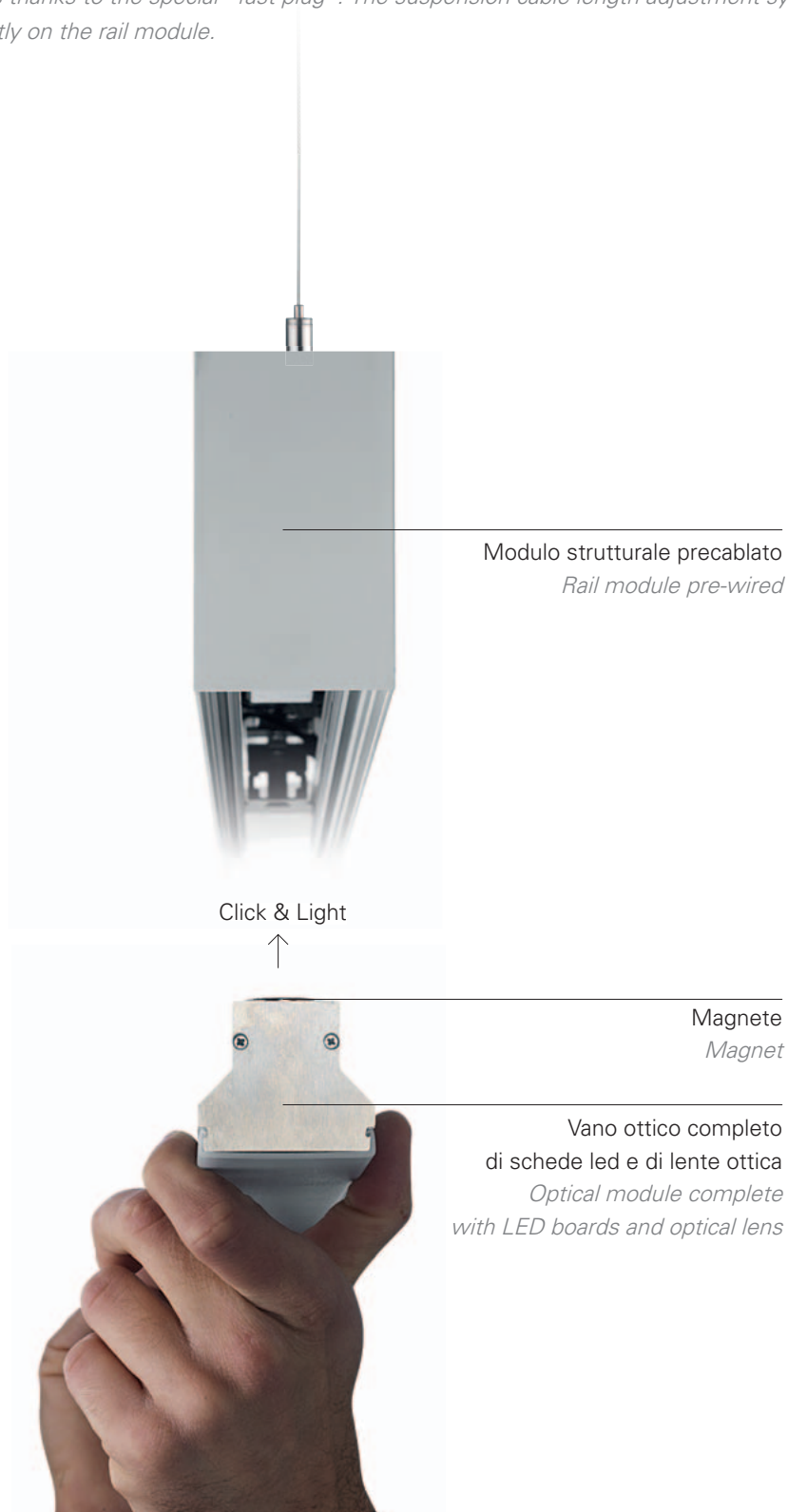

Segno Pendant

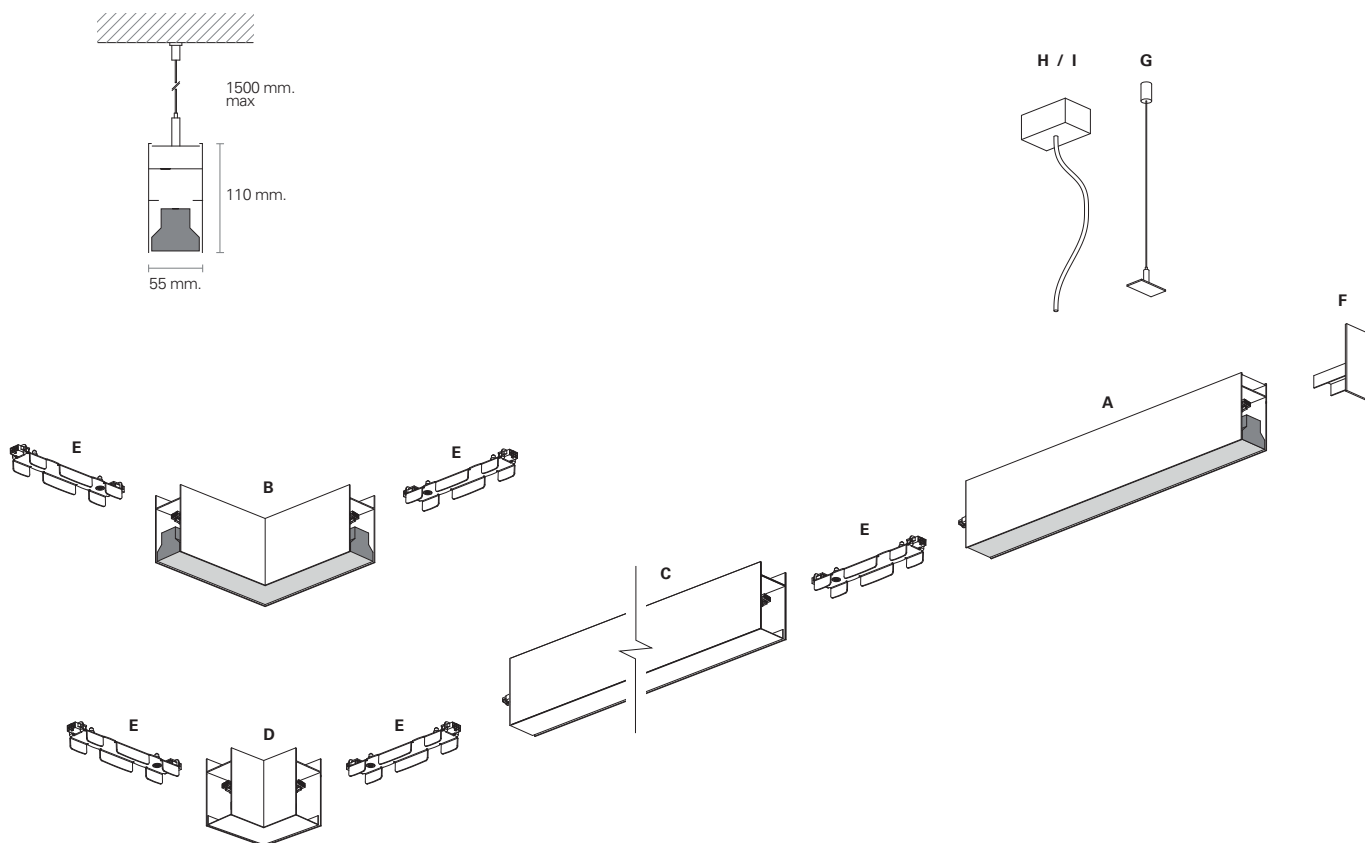

per comporre Segno System - to configure Segno System

- 1 Selezionare i moduli illuminanti e gli accessori di montaggio necessari
Select the lighting modules and mounting accessories needed
- 2 Per accensioni diverse dallo standard On/Off, specificare il tipo di alimentazione elettrica desiderata con l'apposita sigla alla fine del codice del modulo illuminante (verificare tabelle di fattibilità nelle pagine seguenti)
For ignitions different from the standard On/Off, specify the type of feeding desired with the appropriate abbreviation at the end of the code of the lighting module (also check the feasibility tables on the following pages)

alimentazioni - feeding

accensione feeding	note note	sigla da aggiungere sign to add
On / Off	per impianti con accensione On / Off, indicare il solo codice del modulo illuminante scelto (vedi le tabelle dei codici dei moduli illuminanti da pg. 169 a pg. 171). <i>to feed switching On/Off, don't add any sign to the illuminating module (see code list of illuminating modules from pg. 169 to pg. 171).</i>	/
DALI	aggiungere al codice del modulo illuminante la sigla DA per ordinare gli stessi con alimentazione DALI. <i>add sign DA to the code of the lighting modules to order itself in DALI version.</i>	DA
Push Dimmable	aggiungere al codice del modulo illuminante la sigla PU per ordinare gli stessi con alimentazione dimmerabile "Push". <i>add sign PU to the code of the lighting module to order itself in dimmable "Push" version.</i>	PU
Emergency 1 h.	aggiungere al codice del modulo illuminante la lettera H1 per ordinare gli stessi con alimentazione On / Off e completi di kit per emergenza permanente (accensione 0,5 sec. - 1 h. di autonomia). <i>add letters H1 to the lighting module to order On / Off feeding including permanent emergency kit (switch 0,5 secs - 1 h. autonomy).</i>	H1
Casambi	aggiungere al codice del modulo illuminante la lettera CA per ordinare gli stessi con alimentazione digitale Casambi. <i>add letters CA to the lighting module to order On / Off feeding including digital feeding Casambi.</i>	CA
Pan Digital	aggiungere al codice del modulo illuminante la lettera PD per ordinare gli stessi con alimentazione digitale Pan Digital. <i>add letters PD to the lighting module to order On / Off feeding including digital feeding Pan Digital.</i>	PD

per altri tipi di alimentazione contattare l'azienda. - take contact with the company if other different configuration feeding are request.

Moduli Segno Pendant - moduli precablati - *Segno Pendant Modules - wired modules*

riferimento reference	descrizione description	lunghezza length	peso weight	codice code
A	modulo lineare luminoso emissione downlight o uplight/downlight; mono o biaccensione; completo di sorgenti led + lente ottica o schermo diffusore; precablati e completo di connettori fast-plug; driver incluso.	573 mm.	2,95 kg.	vedi codici di tutte le versioni nelle tabella da pg. 169 a pg. 171
		1131 mm.	4,85 kg.	
	linear lighting module <i>downlighter or uplighter/downlighter; single or dual switch; complete with led sources + lenses or diffuser; wired with fast plug connectors; driver included.</i>	1691 mm.	6,45 kg.	see table codes of all versions from pg. 169 to pg. 171
		2250 mm.	8,75 kg.	
B	modulo angolare 90° luminoso emissione downlight; monoaccensione; completo di sorgenti led + lente ottica o schermo diffusore; precablati e completo di connettori fast-plug; driver incluso. comer 90° lighting module <i>downlighter; single switch; with led sources + lenses or diffuser; wired with fast plug connectors; driver included.</i>	600 x 600 mm.	2,40 kg.	ATS03100
C	modulo lineare non luminoso cover inferiore inclusa; completo di cablaggio passante e di connettori fast-plug; senza driver e senza sorgenti luminose.	573 mm.	1,80 kg.	ATS02101
	linear lighting module <i>bottom cover included; complete of passing wiring with fast plug connectors; without led and without driver.</i>	1131 mm.	3,30 kg.	ATS02102
		1691 mm.	4,60 kg.	ATS02103
D	modulo angolare 90° non luminoso cover inferiore inclusa; completo di cablaggio passante e di connettori fast-plug; senza driver e senza sorgenti luminose. comer 90° not lighting module <i>bottom cover included; complete of passing wiring with fast plug connectors; without led and without driver.</i>	250 x 250 mm.	1,10 kg.	ATS03104

Accessori di montaggio - *Mounting accessories*

riferimento reference	descrizione description	lunghezza length	peso weight	codice code
E	giunto meccanico precablati completo di connettori fast-plug per la connessione elettrica dei moduli Segno. mechanical and electrical joint <i>wired with electrical fast plug to connect Segno modules.</i>	\	0,20 kg.	ATS03303
F	tappo terminale in plastica; spessore 3 mm.; per moduli Segno Pendant (1 pezzo) plastic end cap <i>plastic cap; 3 mm. thickness; for Segno Pendant modules (1 piece)</i>	\	0,03 kg.	ATS07301
G	cavo di sospensione in acciaio; completo di nipple per la regolazione dell'altezza di sospensione: portata massima 12 kg. suspension cable <i>steel cable; with height adjustable system; maximum weight strength 12 kg.</i>	1500 mm.	0,05 kg.	ATS05200
H	kit alimentazione 3x 1,5 mm. cavo di alimentazione bianco 3x 1,5 mm.; lunghezza 1500 mm.; completo di rosone precablati (55x90x32 mm). Feeding kit 3x 1,5 mm. <i>white feeding cable 3x 1,5 mm.; 1500 mm. length; complete with wired canopy (90x55x32 mm.)</i>	1650 mm.	0,30 kg.	ATS04203
I	kit alimentazione 5x 1,5 mm. cavo di alimentazione bianco 5x 1,5 mm.; lunghezza 1500 mm.; completo di rosone precablati (55x90x32 mm). Feeding kit 5x 1,5 mm. <i>white feeding cable 5x 1,5 mm.; 1500 mm. length; complete with wired canopy (90x55x32 mm.)</i>	1650 mm.	0,35 kg.	ATS04401

Segno Pendant



Segno Pendant

moduli illuminanti / *lighting modules*

Sospensione Downlight - *Pendant Downlight*

CRI > 90

singola accensione - *single switch*

modello <i>model</i>	versione <i>version</i>	lunghezza <i>length</i>	ottica <i>optic</i>	codice <i>code</i>	CCT <i>CCT</i>	lumen output		efficacia <i>efficacy</i>	colore <i>colour</i>	
						downlight	uplight			
On / Off 220 ÷ 240 V	12W	573 mm.	60° / UGR<19	BHD16410	3000 K	2135 lm	-	178 lm/W	bianco / <i>white</i>	
				BHD16510	4000 K	2200 lm	-	183 lm/W	bianco / <i>white</i>	
			90°	BHD16420	3000 K	2070 lm	-	173 lm/W	bianco / <i>white</i>	
				BHD16520	4000 K	2140 lm	-	178 lm/W	bianco / <i>white</i>	
			120°	BHD16440	3000 K	1525 lm	-	127 lm/W	bianco / <i>white</i>	
				BHD16540	4000 K	1585 lm	-	132 lm/W	bianco / <i>white</i>	
		AS	BHD16450	3000 K	2095 lm	-	175 lm/W	bianco / <i>white</i>		
			BHD16550	4000 K	2160 lm	-	180 lm/W	bianco / <i>white</i>		
		SY	BHD16460	3000 K	2155 lm	-	180 lm/W	bianco / <i>white</i>		
			BHD16560	4000 K	2225 lm	-	185 lm/W	bianco / <i>white</i>		
		24W	1131 mm.	60° / UGR<19	BHD32410	3000 K	4260 lm	-	178 lm/W	bianco / <i>white</i>
					BHD32510	4000 K	4400 lm	-	183 lm/W	bianco / <i>white</i>
	90°			BHD32420	3000 K	4140 lm	-	173 lm/W	bianco / <i>white</i>	
				BHD32520	4000 K	4270 lm	-	178 lm/W	bianco / <i>white</i>	
	120°			BHD32440	3000 K	3050 lm	-	127 lm/W	bianco / <i>white</i>	
				BHD32540	4000 K	3165 lm	-	132 lm/W	bianco / <i>white</i>	
	AS		BHD32450	3000 K	4185 lm	-	174 lm/W	bianco / <i>white</i>		
			BHD32550	4000 K	4320 lm	-	180 lm/W	bianco / <i>white</i>		
	SY		BHD32460	3000 K	4305 lm	-	179 lm/W	bianco / <i>white</i>		
			BHD32560	4000 K	4445 lm	-	185 lm/W	bianco / <i>white</i>		
	36W		1691 mm.	60° / UGR<19	BHD48410	3000 K	6395 lm	-	178 lm/W	bianco / <i>white</i>
					BHD48510	4000 K	6600 lm	-	183 lm/W	bianco / <i>white</i>
		90°		BHD48420	3000 K	6205 lm	-	172 lm/W	bianco / <i>white</i>	
				BHD48520	4000 K	6410 lm	-	178 lm/W	bianco / <i>white</i>	
120°		BHD48440		3000 K	4575 lm	-	127 lm/W	bianco / <i>white</i>		
		BHD48540		4000 K	4745 lm	-	132 lm/W	bianco / <i>white</i>		
AS		BHD48450	3000 K	6270 lm	-	174 lm/W	bianco / <i>white</i>			
		BHD48550	4000 K	6470 lm	-	180 lm/W	bianco / <i>white</i>			
SY		BHD48460	3000 K	6455 lm	-	179 lm/W	bianco / <i>white</i>			
		BHD48560	4000 K	6665 lm	-	185 lm/W	bianco / <i>white</i>			
48W		2250 mm.	60° / UGR<19	BHD64410	3000 K	8520 lm	-	178 lm/W	bianco / <i>white</i>	
				BHD64510	4000 K	8800 lm	-	183 lm/W	bianco / <i>white</i>	
	90°		BHD64420	3000 K	8275 lm	-	172 lm/W	bianco / <i>white</i>		
			BHD64520	4000 K	8540 lm	-	178 lm/W	bianco / <i>white</i>		
	120°		BHD64440	3000 K	6095 lm	-	127 lm/W	bianco / <i>white</i>		
			BHD64540	4000 K	6320 lm	-	132 lm/W	bianco / <i>white</i>		
	AS	BHD64450	3000 K	8360 lm	-	174 lm/W	bianco / <i>white</i>			
		BHD64550	4000 K	8630 lm	-	180 lm/W	bianco / <i>white</i>			
	SY	BHD64460	3000 K	8605 lm	-	179 lm/W	bianco / <i>white</i>			
		BHD64560	4000 K	8885 lm	-	185 lm/W	bianco / <i>white</i>			

⊕ IP20 L80-B10 / 60.000 h.

Altre alimentazioni / *Other feedings*

Per ordinare Segno, nella versione Sospensione Downlight monoaccensione con alimentazioni alternative rispetto allo standard On/Off, aggiungere al codice standard la sigla riportata nella tabella a fianco.

To order Segno in single switch Pendant Downlight version differently feeded from standard On / Off model, add the abbreviation shown i in the opposite table to the standard code.

Versioni in emergenza per Casambi e Pan Digital su richiesta. Contattare l'Azienda.

Emergency versions with Casambi or Pan Digital feeding on request. Take contact with the Company.

	versione <i>version</i>	DALI	Dimm. Push (*)	Emerg. 1 h	Casambi	Pan Digital
downlight single switch	12W	\	\	\	\	\
	24W	DA	PU	\	CA	PD
	36W	DA	PU	H1	CA	PD
	48W	DA	PU	H1	CA	PD

(*) Massimo 4 moduli illuminanti. / (*) Up to 4 lighting modules.

Segno Pendant

moduli illuminanti / *lighting modules*

Sospensione Uplight / Downlight - *Pendant Uplight / Downlight*

CRI > 90

singola accensione - *single switch*

modello <i>model</i>	versione <i>version</i>	lunghezza <i>length</i>	ottica <i>optic</i>	codice <i>code</i>	CCT <i>CCT</i>	lumen output		efficacia <i>efficacy</i>	colore <i>colour</i>	
						downlight	uplight			
On / Off 220 ÷ 240 V	12+4 W	573 mm.	60° / UGR<19	BSU20410	3000 K	2125 lm	420 lm	159 lm/W	bianco / <i>white</i>	
				BSU20510	4000 K	2210 lm	440 lm	166 lm/W	bianco / <i>white</i>	
			90°	BSU20420	3000 K	2060 lm	405 lm	154 lm/W	bianco / <i>white</i>	
				BSU20520	4000 K	2150 lm	425 lm	161 lm/W	bianco / <i>white</i>	
			120°	BSU20440	3000 K	1535 lm	450 lm	124 lm/W	bianco / <i>white</i>	
				BSU20540	4000 K	1580 lm	475 lm	128 lm/W	bianco / <i>white</i>	
	AS	BSU20450	3000 K	2080 lm	410 lm	156 lm/W	bianco / <i>white</i>			
		BSU20550	4000 K	2170 lm	430 lm	163 lm/W	bianco / <i>white</i>			
	SY	BSU20460	3000 K	2145 lm	420 lm	160 lm/W	bianco / <i>white</i>			
		BSU20560	4000 K	2235 lm	445 lm	168 lm/W	bianco / <i>white</i>			
	24+12 W	1131 mm.	60° / UGR<19	BSU47410	3000 K	4270 lm	1660 lm	165 lm/W	bianco / <i>white</i>	
				BSU47510	4000 K	4420 lm	1715 lm	170 lm/W	bianco / <i>white</i>	
			90°	BSU47420	3000 K	4145 lm	1615 lm	160 lm/W	bianco / <i>white</i>	
				BSU47520	4000 K	4290 lm	1665 lm	165 lm/W	bianco / <i>white</i>	
			120°	BSU47440	3000 K	3060 lm	1800 lm	135 lm/W	bianco / <i>white</i>	
				BSU47540	4000 K	3170 lm	1865 lm	140 lm/W	bianco / <i>white</i>	
		AS	BSU47450	3000 K	4190 lm	1630 lm	162 lm/W	bianco / <i>white</i>		
			BSU47550	4000 K	4340 lm	1680 lm	167 lm/W	bianco / <i>white</i>		
		SY	BSU47460	3000 K	4315 lm	1675 lm	166 lm/W	bianco / <i>white</i>		
			BSU47560	4000 K	4465 lm	1730 lm	172 lm/W	bianco / <i>white</i>		
		36+12 W	1691 mm.	60° / UGR<19	BSU65410	3000 K	6365 lm	1660 lm	167 lm/W	bianco / <i>white</i>
					BSU65510	4000 K	6665 lm	1715 lm	175 lm/W	bianco / <i>white</i>
	90°			BSU65420	3000 K	6180 lm	1615 lm	162 lm/W	bianco / <i>white</i>	
				BSU65520	4000 K	6470 lm	1665 lm	169 lm/W	bianco / <i>white</i>	
120°	BSU65440			3000 K	4545 lm	1800 lm	132 lm/W	bianco / <i>white</i>		
	BSU65540			4000 K	4790 lm	1865 lm	139 lm/W	bianco / <i>white</i>		
AS	BSU65450		3000 K	6240 lm	1630 lm	164 lm/W	bianco / <i>white</i>			
	BSU65550		4000 K	6535 lm	1680 lm	171 lm/W	bianco / <i>white</i>			
SY	BSU65460		3000 K	6430 lm	1675 lm	169 lm/W	bianco / <i>white</i>			
	BSU65560		4000 K	6730 lm	1730 lm	176 lm/W	bianco / <i>white</i>			
48+24 W	2250 mm.		60° / UGR<19	BSU98410	3000 K	8545 lm	3305 lm	165 lm/W	bianco / <i>white</i>	
				BSU98510	4000 K	8840 lm	3425 lm	170 lm/W	bianco / <i>white</i>	
		90°	BSU98420	3000 K	8295 lm	3210 lm	160 lm/W	bianco / <i>white</i>		
			BSU98520	4000 K	8580 lm	3325 lm	165 lm/W	bianco / <i>white</i>		
		120°	BSU98440	3000 K	6125 lm	3590 lm	135 lm/W	bianco / <i>white</i>		
			BSU98540	4000 K	6330 lm	3720 lm	140 lm/W	bianco / <i>white</i>		
	AS	BSU98450	3000 K	8380 lm	3240 lm	161 lm/W	bianco / <i>white</i>			
		BSU98550	4000 K	8670 lm	3355 lm	167 lm/W	bianco / <i>white</i>			
	SY	BSU98460	3000 K	8630 lm	3335 lm	166 lm/W	bianco / <i>white</i>			
		BSU98560	4000 K	8925 lm	3455 lm	172 lm/W	bianco / <i>white</i>			

⊕ IP40 L80-B10 / 60.000 h.

Altre alimentazioni / *Other feedings*

Per ordinare Segno, nella versione Sospensione Uplight / Downlight monoaccensione con alimentazioni alternative rispetto allo standard On/Off, aggiungere al codice standard la sigla riportata nella tabella a fianco.

To order Segno single switch Pendant Uplight / Downlight version differently fedded from standard On / Off model, add the abbreviation shown in the opposite table to the standard code.

Versioni in emergenza per Casambi e Pan Digital su richiesta. Contattare l'Azienda.

Emergency versions with Casambi or Pan Digital feeding on request. Take contact with the Company.

	versione <i>version</i>	DALI	Dimm. Push (*)	Emerg. 1 h	Casambi	Pan Digital
uplight / downlight single switch	12+4 W	\	\	\	\	\
	24+12 W	DA	PU	\	CA	PD
	36+12 W	DA	PU	H1	CA	PD
	48+24 W	DA	PU	H1	CA	PD

(*) Massimo 4 moduli illuminanti. / (*) Up to 4 lighting modules.

Segno Pendant

moduli illuminanti / *lighting modules*

Sospensione Uplight / Downlight - *Pendant Uplight / Downlight*

CRI > 90

doppia accensione - *dual switch*

modello <i>model</i>	versione <i>version</i>	lunghezza <i>length</i>	ottica <i>optic</i>	codice <i>code</i>	CCT <i>CCT</i>	lumen output		efficacia <i>efficacy</i>	colore <i>colour</i>
						downlight	uplight		
On / Off 220 ÷ 240 V	24+12 W	1131 mm.	60° / UGR<19	BSB47410	3000 K	4270 lm	1660 lm	165 lm/W	bianco / <i>white</i>
				BSB47510	4000 K	4420 lm	1715 lm	170 lm/W	bianco / <i>white</i>
			90°	BSB47420	3000 K	4145 lm	1615 lm	160 lm/W	bianco / <i>white</i>
				BSB47520	4000 K	4290 lm	1665 lm	165 lm/W	bianco / <i>white</i>
			120°	BSB47440	3000 K	3060 lm	1800 lm	135 lm/W	bianco / <i>white</i>
				BSB47540	4000 K	3170 lm	1865 lm	140 lm/W	bianco / <i>white</i>
	AS	BSB47450	3000 K	4190 lm	1630 lm	162 lm/W	bianco / <i>white</i>		
		BSB47550	4000 K	4340 lm	1680 lm	167 lm/W	bianco / <i>white</i>		
	SY	BSB47460	3000 K	4315 lm	1675 lm	166 lm/W	bianco / <i>white</i>		
		BSB47560	4000 K	4465 lm	1730 lm	172 lm/W	bianco / <i>white</i>		
	36+12 W	1691 mm.	60° / UGR<19	BSB65410	3000 K	6365 lm	1660 lm	167 lm/W	bianco / <i>white</i>
				BSB65510	4000 K	6665 lm	1715 lm	175 lm/W	bianco / <i>white</i>
			90°	BSB65420	3000 K	6180 lm	1615 lm	162 lm/W	bianco / <i>white</i>
				BSB65520	4000 K	6470 lm	1665 lm	169 lm/W	bianco / <i>white</i>
			120°	BSB65440	3000 K	4545 lm	1800 lm	132 lm/W	bianco / <i>white</i>
				BSB65540	4000 K	4790 lm	1865 lm	139 lm/W	bianco / <i>white</i>
		AS	BSB65450	3000 K	6240 lm	1630 lm	164 lm/W	bianco / <i>white</i>	
			BSB65550	4000 K	6535 lm	1680 lm	171 lm/W	bianco / <i>white</i>	
SY		BSB65460	3000 K	6430 lm	1675 lm	169 lm/W	bianco / <i>white</i>		
		BSB65560	4000 K	6730 lm	1730 lm	176 lm/W	bianco / <i>white</i>		
48+24 W		2250 mm.	60° / UGR<19	BSB98410	3000 K	8545 lm	3305 lm	165 lm/W	bianco / <i>white</i>
				BSB98510	4000 K	8840 lm	3425 lm	170 lm/W	bianco / <i>white</i>
	90°		BSB98420	3000 K	8295 lm	3210 lm	160 lm/W	bianco / <i>white</i>	
			BSB98520	4000 K	8580 lm	3325 lm	165 lm/W	bianco / <i>white</i>	
	120°		BSB98440	3000 K	6125 lm	3590 lm	135 lm/W	bianco / <i>white</i>	
			BSB98540	4000 K	6330 lm	3720 lm	140 lm/W	bianco / <i>white</i>	
AS	BSB98450	3000 K	8380 lm	3240 lm	161 lm/W	bianco / <i>white</i>			
	BSB98550	4000 K	8670 lm	3355 lm	167 lm/W	bianco / <i>white</i>			
SY	BSB98460	3000 K	8630 lm	3335 lm	166 lm/W	bianco / <i>white</i>			
	BSB98560	4000 K	8925 lm	3455 lm	172 lm/W	bianco / <i>white</i>			

⊕ IP40 L80-B10 / 60.000 h.

Altre alimentazioni / *Other feedings*

Per ordinare Segno, nella versione Sospensione Uplight / Downlight in doppia accensione con alimentazioni alternative rispetto allo standard On/Off, aggiungere al codice standard la sigla riportata nella tabella a fianco.

To order Segno dual switch Pendant Uplight / Downlight version differently fed from standard On / Off model, add the abbreviation shown in the opposite table to the standard code.

Versioni in emergenza per Casambi e Pan Digital su richiesta. Contattare l'Azienda.

Emergency versions with Casambi or Pan Digital feeding on request. Take contact with the Company.

	versione <i>version</i>	DALI	Dimm. Push (*)	Emerg. 1 h	Casambi	Pan Digital
uplight / downlight dual switch	24+12 W	DA	PU	\	CA	PD
	36+12 W	DA	PU	H1	CA	PD
	48+24 W	DA	PU	H1	CA	PD

(*) Massimo 4 moduli illuminanti. / (*) Up to 4 lighting modules.

Segno Ceiling

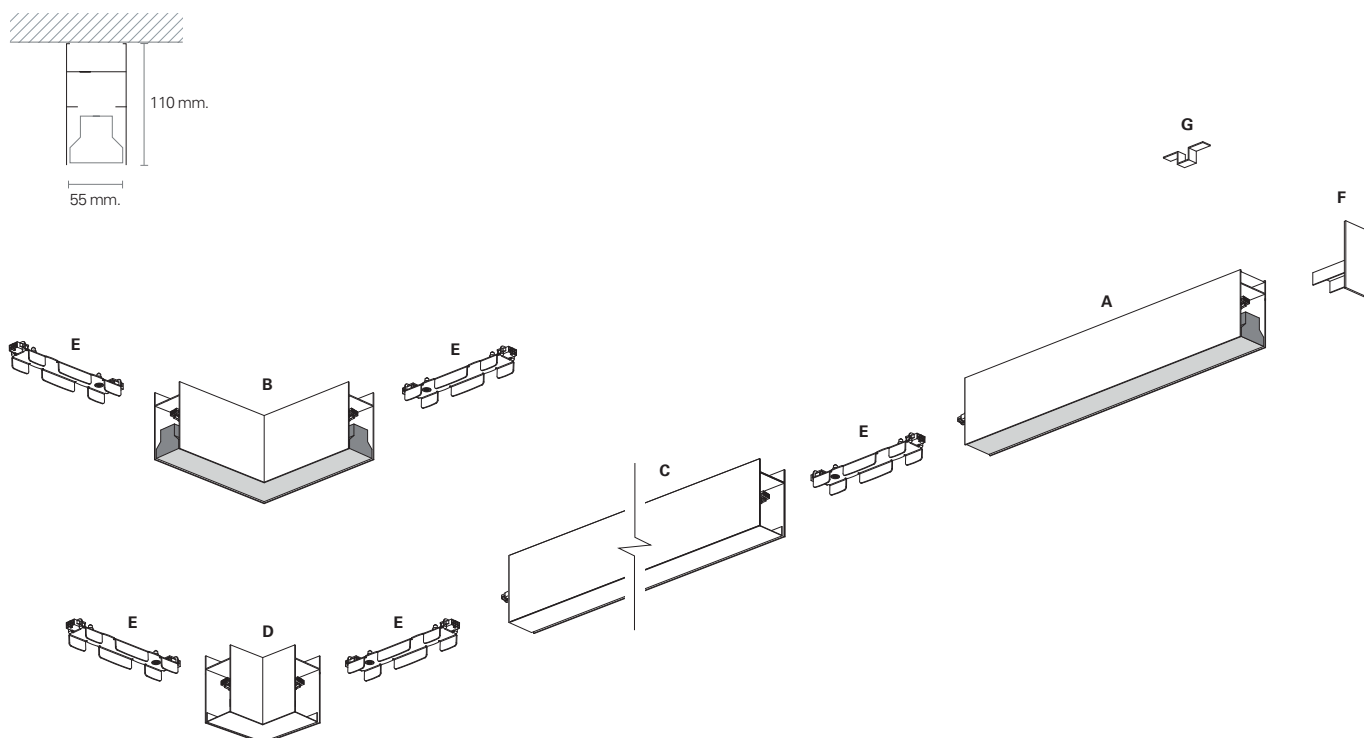

per comporre Segno System - to configure Segno System

- 1 Selezionare i moduli illuminanti e gli accessori di montaggio necessari
Select the lighting modules and mounting accessories needed
- 2 Per accensioni diverse dallo standard On/Off, specificare il tipo di alimentazione elettrica desiderata con l'apposita sigla alla fine del codice del modulo illuminante (verificare tabelle di fattibilità nelle pagine seguenti)
For ignitions different from the standard On/Off, specify the type of feeding desired with the appropriate abbreviation at the end of the code of the lighting module (also check the feasibility tables on the following pages)

alimentazioni - feeding

accensione feeding	note note	sigla da aggiungere sign to add
On / Off	per impianti con accensione On / Off, indicare il solo codice del modulo illuminante scelto (vedi le tabelle dei codici dei moduli illuminanti a pg. 175). <i>to feed switching On / Off, don't add any sign to the illuminating module (see code list of illuminating modules from pg. 175).</i>	/
DALI	aggiungere al codice del modulo illuminante la sigla DA per ordinare gli stessi con alimentazione DALI. <i>add sign DA to the code of the lighting modules to order itself in DALI version.</i>	DA
Push Dimmable	aggiungere al codice del modulo illuminante la sigla PU per ordinare gli stessi con alimentazione dimmerabile "Push". <i>add sign PU to the code of the lighting module to order itself in dimmable "Push" version.</i>	PU
Emergency 1 h.	aggiungere al codice del modulo illuminante la lettera H1 per ordinare gli stessi con alimentazione On / Off e completi di kit per emergenza permanente (accensione 0,5 sec. - 1 h. di autonomia). <i>add letters H1 to the lighting module to order On / Off feeding including permanent emergency kit (switch 0,5 secs - 1 h. autonomy).</i>	H1
Casambi	aggiungere al codice del modulo illuminante la lettera CA per ordinare gli stessi con alimentazione digitale Casambi. <i>add letters CA to the lighting module to order On / Off feeding including digital feeding Casambi.</i>	CA
Pan Digital	aggiungere al codice del modulo illuminante la lettera PD per ordinare gli stessi con alimentazione digitale Pan Digital. <i>add letters PD to the lighting module to order On / Off feeding including digital feeding Pan Digital.</i>	PD

per altri tipi di alimentazione contattare l'azienda. - take contact with the company if other different configuration feeding are request.

Moduli Segno Ceiling- moduli precablati - *Segno Ceiling Modules - wired modules*

riferimento reference	descrizione description	lunghezza length	peso weight	codice code
A	modulo lineare luminoso emissione downlight; monoaccensione; completo di sorgenti led + lente ottica o schermo diffusore; precablato e completo di connettori fast-plug; driver incluso. linear lighting module <i>downlighter; single switch; complete with led sources + lenses or diffuser; wired with fast plug connectors; driver included.</i>	573 mm.	2,95 kg.	vedi codici di tutte le versioni nelle tabella a pg. 175 <i>see table codes of all versions from pg. 175</i>
		1131 mm.	4,85 kg.	
		1691 mm.	6,45 kg.	
		2250 mm.	8,75 kg.	
B	modulo angolare 90° luminoso emissione downlight; monoaccensione; completo di sorgenti led + lente ottica o schermo diffusore; precablato e completo di connettori fast-plug; driver incluso. corner 90° lighting module <i>downlighter; single switch; with led sources + lenses or diffuser; wired with fast plug connectors; driver included.</i>	600 x 600 mm.	2,40 kg.	ATS03100
C	modulo lineare non luminoso cover inferiore inclusa; completo di cablaggio passante e di connettori fast-plug; senza driver e senza sorgenti luminose. linear lighting module <i>bottom cover included; complete of passing wiring with fast plug connectors; without led and without driver.</i>	573 mm.	1,80 kg.	ATS02101
		1131 mm.	3,30 kg.	ATS02102
		1691 mm.	4,60 kg.	ATS02103
D	modulo angolare 90° non luminoso cover inferiore inclusa; completo di cablaggio passante e di connettori fast-plug; senza driver e senza sorgenti luminose. corner 90° not lighting module <i>bottom cover included; complete of passing wiring with fast plug connectors; without led and without driver.</i>	250 x 250 mm.	1,10 kg.	ATS03104

Accessori di montaggio - *Mounting accessories*

riferimento reference	descrizione description	lunghezza length	peso weight	codice code
E	giunto meccanico precablato completo di connettori fast-plug per la connessione elettrica dei moduli Segno. mechanical and electrical joint <i>wired with electrical fast plug to connect Segno modules.</i>	\	0,20 kg.	ATS03303
F	tappo terminale in plastica; spessore 3 mm.; per moduli Segno Ceiling (1 pezzo). plastic end cap <i>plastic cap; 3 mm. thickness; for Segno Ceiling modules (1 piece).</i>	\	0,03 kg.	ATS07301
G	staffa a soffitto in acciaio zincato; per installazione a soffitto (1 pezzo). mounting bracket <i>galvanized steel bracket; for ceiling mounting (1 piece).</i>	\	0,08 kg.	ATS05202



Karma e Segno System sono realizzabili in finitura nero opaca su richiesta
Karma and Segno System can be supplied in matt black finish on request

Segno Ceiling

moduli illuminanti / *lighting modules*

Plafone Downlight - *Ceiling Mounted Downlight*

CRI > 90

singola accensione - *single switch*

modello <i>model</i>	versione <i>version</i>	lunghezza <i>length</i>	ottica <i>optic</i>	codice <i>code</i>	CCT <i>CCT</i>	lumen output		efficacia <i>efficacy</i>	colore <i>colour</i>	
						downlight	uplight			
On / Off 220 ÷ 240 V	12W	573 mm.	60° / UGR<19	BHD16410	3000 K	2135 lm	-	178 lm/W	bianco / <i>white</i>	
				BHD16510	4000 K	2200 lm	-	183 lm/W	bianco / <i>white</i>	
			90°	BHD16420	3000 K	2070 lm	-	173 lm/W	bianco / <i>white</i>	
				BHD16520	4000 K	2140 lm	-	178 lm/W	bianco / <i>white</i>	
			120°	BHD16440	3000 K	1525 lm	-	127 lm/W	bianco / <i>white</i>	
				BHD16540	4000 K	1585 lm	-	132 lm/W	bianco / <i>white</i>	
		AS	BHD16450	3000 K	2095 lm	-	175 lm/W	bianco / <i>white</i>		
			BHD16550	4000 K	2160 lm	-	180 lm/W	bianco / <i>white</i>		
		SY	BHD16460	3000 K	2155 lm	-	180 lm/W	bianco / <i>white</i>		
			BHD16560	4000 K	2225 lm	-	185 lm/W	bianco / <i>white</i>		
		24W	1131 mm.	60° / UGR<19	BHD32410	3000 K	4260 lm	-	178 lm/W	bianco / <i>white</i>
					BHD32510	4000 K	4400 lm	-	183 lm/W	bianco / <i>white</i>
	90°			BHD32420	3000 K	4140 lm	-	173 lm/W	bianco / <i>white</i>	
				BHD32520	4000 K	4270 lm	-	178 lm/W	bianco / <i>white</i>	
	120°			BHD32440	3000 K	3050 lm	-	127 lm/W	bianco / <i>white</i>	
				BHD32540	4000 K	3165 lm	-	132 lm/W	bianco / <i>white</i>	
	AS		BHD32450	3000 K	4185 lm	-	174 lm/W	bianco / <i>white</i>		
			BHD32550	4000 K	4320 lm	-	180 lm/W	bianco / <i>white</i>		
	SY		BHD32460	3000 K	4305 lm	-	179 lm/W	bianco / <i>white</i>		
			BHD32560	4000 K	4445 lm	-	185 lm/W	bianco / <i>white</i>		
	36W		1691 mm.	60° / UGR<19	BHD48410	3000 K	6395 lm	-	178 lm/W	bianco / <i>white</i>
					BHD48510	4000 K	6600 lm	-	183 lm/W	bianco / <i>white</i>
		90°		BHD48420	3000 K	6205 lm	-	172 lm/W	bianco / <i>white</i>	
				BHD48520	4000 K	6410 lm	-	178 lm/W	bianco / <i>white</i>	
120°		BHD48440		3000 K	4575 lm	-	127 lm/W	bianco / <i>white</i>		
		BHD48540		4000 K	4745 lm	-	132 lm/W	bianco / <i>white</i>		
AS		BHD48450	3000 K	6270 lm	-	174 lm/W	bianco / <i>white</i>			
		BHD48550	4000 K	6470 lm	-	180 lm/W	bianco / <i>white</i>			
SY		BHD48460	3000 K	6455 lm	-	179 lm/W	bianco / <i>white</i>			
		BHD48560	4000 K	6665 lm	-	185 lm/W	bianco / <i>white</i>			
48W		2250 mm.	60° / UGR<19	BHD64410	3000 K	8520 lm	-	178 lm/W	bianco / <i>white</i>	
				BHD64510	4000 K	8800 lm	-	183 lm/W	bianco / <i>white</i>	
	90°		BHD64420	3000 K	8275 lm	-	172 lm/W	bianco / <i>white</i>		
			BHD64520	4000 K	8540 lm	-	178 lm/W	bianco / <i>white</i>		
	120°		BHD64440	3000 K	6095 lm	-	127 lm/W	bianco / <i>white</i>		
			BHD64540	4000 K	6320 lm	-	132 lm/W	bianco / <i>white</i>		
	AS	BHD64450	3000 K	8360 lm	-	174 lm/W	bianco / <i>white</i>			
		BHD64550	4000 K	8630 lm	-	180 lm/W	bianco / <i>white</i>			
	SY	BHD64460	3000 K	8605 lm	-	179 lm/W	bianco / <i>white</i>			
		BHD64560	4000 K	8885 lm	-	185 lm/W	bianco / <i>white</i>			

⊕ IP20 L80-B10 / 60.000 h.

Altre alimentazioni / *Other feedings*

Per ordinare Segno, nella versione Plafone Downlight monoaccensione con alimentazioni alternative rispetto allo standard On/Off, aggiungere al codice standard la sigla riportata nella tabella a fianco.

To order Segno single switch Ceiling Mounted Downlight version differently feeded from standard On / Off model, add the abbreviation shown in the opposite table to the standard code.

Versioni in emergenza per Casambi e Pan Digital su richiesta. Contattare l'Azienda.

Emergency versions with Casambi or Pan Digital feeding on request. Take contact with the Company.

	versione <i>version</i>	DALI	Dimm. Push (*)	Emerg. 1 h	Casambi	Pan Digital
downlight single switch	12W	\	\	\	\	\
	24W	DA	PU	\	CA	PD
	36W	DA	PU	H1	CA	PD
	48W	DA	PU	H1	CA	PD

(*) Massimo 4 moduli illuminanti. / (*) Up to 4 lighting modules.

Segno Wall





Segno Wall

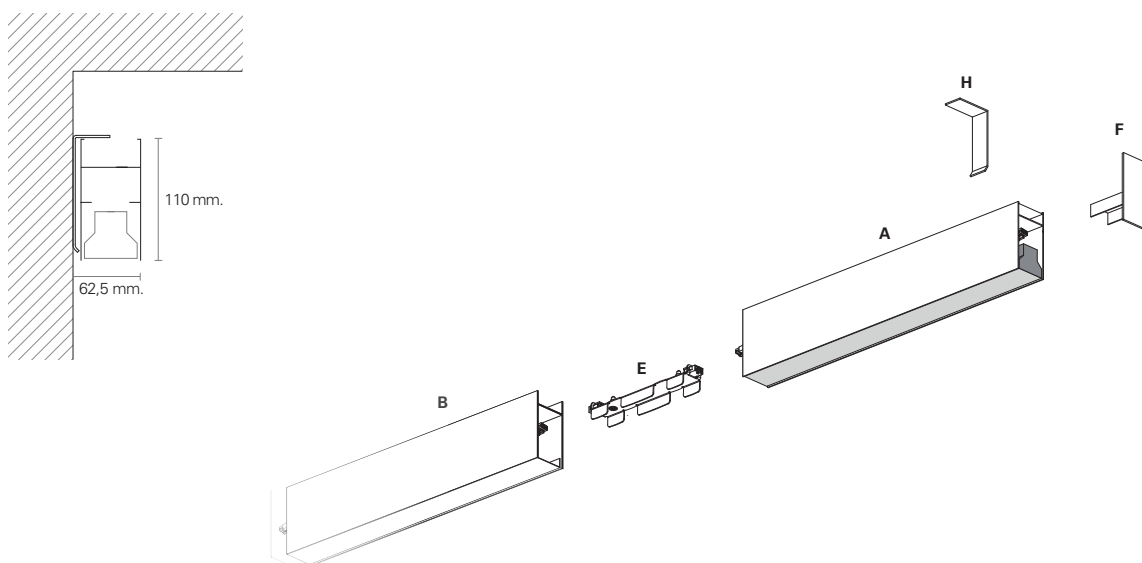

per comporre Segno System - to configure Segno System

- 1 Selezionare i moduli illuminanti e gli accessori di montaggio necessari
Select the lighting modules and mounting accessories needed
- 2 Per accensioni diverse dallo standard On/Off, specificare il tipo di alimentazione elettrica desiderata con l'apposita sigla alla fine del codice del modulo illuminante (verificare tabelle di fattibilità nelle pagine seguenti)
For ignitions different from the standard On/Off, specify the type of feeding desired with the appropriate abbreviation at the end of the code of the lighting module (also check the feasibility tables on the following pages)

alimentazioni - feeding

accensione feeding	note note	sigla da aggiungere sign to add
On / Off	per impianti con accensione On / Off, indicare il solo codice del modulo illuminante scelto (vedi le tabelle dei codici dei moduli illuminanti da pg. 180 a pg. 181). <i>to feed switching On/Off, don't add any sign to the illuminating module (see code list of illuminating modules from pg. 180 to pg. 181).</i>	/
DALI	aggiungere al codice del modulo illuminante la sigla DA per ordinare gli stessi con alimentazione DALI. <i>add sign DA to the code of the lighting modules to order itself in DALI version.</i>	DA
Push Dimmable	aggiungere al codice del modulo illuminante la sigla PU per ordinare gli stessi con alimentazione dimmerabile "Push". <i>add sign PU to the code of the lighting module to order itself in dimmable "Push" version.</i>	PU
Emergency 1 h.	aggiungere al codice del modulo illuminante la lettera H1 per ordinare gli stessi con alimentazione On / Off e completi di kit per emergenza permanente (accensione 0,5 sec. - 1 h. di autonomia). <i>add letters H1 to the lighting module to order On / Off feeding including permanent emergency kit (switch 0,5 secs - 1 h. autonomy).</i>	H1
Casambi	aggiungere al codice del modulo illuminante la lettera CA per ordinare gli stessi con alimentazione digitale Casambi. <i>add letters CA to the lighting module to order On / Off feeding including digital feeding Casambi.</i>	CA
Pan Digital	aggiungere al codice del modulo illuminante la lettera PD per ordinare gli stessi con alimentazione digitale Pan Digital. <i>add letters PD to the lighting module to order On / Off feeding including digital feeding Pan Digital.</i>	PD

per altri tipi di alimentazione contattare l'azienda. - take contact with the company if other different configuration feeding are request.

Moduli Segno Wall- moduli precablati - *Segno Wall Modules - wired modules*

riferimento reference	descrizione description	lunghezza length	peso weight	codice code
A	modulo lineare luminoso emissione downlight o uplight/downlight; mono o biaccensione; completo di sorgenti led + lente ottica o schermo diffusore; precablati e completo di connettori fast-plug; driver incluso. linear lighting module downlighter or uplighter/downlighter; single or dual switch; complete with led sources + lenses or diffuser; wired with fast plug connectors; driver included.	573 mm.	2,95 kg.	vedi codici di tutte le versioni nelle tabella da pg. 180 a pg. 181 <i>see table codes of all versions from pg. 180 to pg. 181</i>
		1131 mm.	4,85 kg.	
		1691 mm.	6,45 kg.	
		2250 mm.	8,75 kg.	
B	modulo lineare non luminoso cover inferiore inclusa; completo di cablaggio passante e di connettori fast-plug; senza driver e senza sorgenti luminose. linear lighting module bottom cover included; complete of passing wiring with fast plug connectors; without led and without driver.	573 mm.	1,80 kg.	ATS02101
		1131 mm.	3,30 kg.	ATS02102
		1691 mm.	4,60 kg.	ATS02103

Accessori di montaggio - *Mounting accessories*

riferimento reference	descrizione description	lunghezza length	peso weight	codice code
E	giunto meccanico precablato completo di connettori fast-plug per la connessione elettrica dei moduli Segno. mechanical and electrical joint wired with electrical fast plug to connect Segno modules.	\	0,20 kg.	ATS03303
F	tappo terminale in plastica; spessore 1 mm., per moduli Segno (1 pezzo). plastic end cap plastic cap; 1 mm. thickness; for Segno modules (1 piece).	\	0,03 kg.	ATS07301
H	staffa a parete in acciaio zincato; per installazione a parete (1 pezzo). Wall bracket galvanized steel bracket; for wall mounting (1 piece).	\	0,11 kg.	ATS05201

Segno Wall

moduli illuminanti / *lighting modules*

Parete Downlight - *Wall Mounted Downlight*

CRI > 90

singola accensione - *single switch*

modello <i>model</i>	versione <i>version</i>	lunghezza <i>length</i>	ottica <i>optic</i>	codice <i>code</i>	CCT <i>CCT</i>	lumen output		efficacia <i>efficacy</i>	colore <i>colour</i>
						downlight	uplight		
On / Off 220 ÷ 240 V	12 W	573 mm.	120°	BWD16440	3000 K	1525 lm	-	127 lm/W	bianco / <i>white</i>
				BWD16540	4000 K	1585 lm	-	132 lm/W	bianco / <i>white</i>
			AS	BWD16450	3000 K	2095 lm	-	175 lm/W	bianco / <i>white</i>
				BWD16550	4000 K	2160 lm	-	180 lm/W	bianco / <i>white</i>
	24 W	1131 mm.	120°	BWD32440	3000 K	3050 lm	-	127 lm/W	bianco / <i>white</i>
				BWD32540	4000 K	3165 lm	-	132 lm/W	bianco / <i>white</i>
			AS	BWD32450	3000 K	4185 lm	-	174 lm/W	bianco / <i>white</i>
				BWD32550	4000 K	4320 lm	-	180 lm/W	bianco / <i>white</i>
	36 W	1691 mm.	120°	BWD48440	3000 K	4575 lm	-	127 lm/W	bianco / <i>white</i>
				BWD48540	4000 K	4745 lm	-	132 lm/W	bianco / <i>white</i>
			AS	BWD48450	3000 K	6270 lm	-	174 lm/W	bianco / <i>white</i>
				BWD48550	4000 K	6470 lm	-	180 lm/W	bianco / <i>white</i>
	48 W	2250 mm.	120°	BWD64440	3000 K	6095 lm	-	127 lm/W	bianco / <i>white</i>
				BWD64540	4000 K	6320 lm	-	132 lm/W	bianco / <i>white</i>
			AS	BWD64450	3000 K	8360 lm	-	174 lm/W	bianco / <i>white</i>
				BWD64550	4000 K	8630 lm	-	180 lm/W	bianco / <i>white</i>

⊕ IP20 L80-B10 / 60.000 h.

Altre alimentazioni / *Other feedings*

Per ordinare Segno, nella versione Parete Downlight monoaccensione con alimentazioni alternative rispetto allo standard On/Off, aggiungere al codice standard la sigla riportata nella tabella a fianco.
To order Segno single switch Wall Mounted Downlight version differently feeded from standard On / Off model, add the abbreviation shown in the opposite table to the standard code.

Versioni in emergenza per Casambi e Pan Digital su richiesta. Contattare l'Azienda.

Emergency versions with Casambi or Pan Digital feeding on request. Take contact with the Company.

	versione <i>version</i>	DALI	Dimm. Push (*)	Emerg. 1 h	Casambi	Pan Digital
downlight single switch	12 W	\	\	\	\	\
	24 W	DA	PU	\	CA	PD
	36 W	DA	PU	H1	CA	PD
	48 W	DA	PU	H1	CA	PD

(*) Massimo 4 moduli illuminanti. / (*) Up to 4 lighting modules.

Segno Wall

moduli illuminanti / *lighting modules*

Parete Uplight / Downlight - Wall Mounted Uplight / Downlight

CRI > 90

singola accensione - *single switch*

modello <i>model</i>	versione <i>version</i>	lunghezza <i>length</i>	ottica <i>optic</i>	codice <i>code</i>	CCT <i>CCT</i>	lumen output		efficacia <i>efficacy</i>	colore <i>colour</i>
						downlight	uplight		
On / Off 220 ÷ 240 V	12+4 W	573 mm.	120°	BWU20440	3000 K	1535 lm	450 lm	124 lm/W	bianco / <i>white</i>
				BWU20540	4000 K	1580 lm	475 lm	128 lm/W	bianco / <i>white</i>
			AS	BWU20450	3000 K	2080 lm	410 lm	156 lm/W	bianco / <i>white</i>
			BWU20550	4000 K	2170 lm	430 lm	163 lm/W	bianco / <i>white</i>	
	24+12 W	1131 mm.	120°	BWU47440	3000 K	3060 lm	1800 lm	135 lm/W	bianco / <i>white</i>
				BWU47540	4000 K	3170 lm	1865 lm	140 lm/W	bianco / <i>white</i>
			AS	BWU47450	3000 K	4190 lm	1630 lm	162 lm/W	bianco / <i>white</i>
			BWU47550	4000 K	4340 lm	1680 lm	167 lm/W	bianco / <i>white</i>	
	36+12 W	1691 mm.	120°	BWU65440	3000 K	4545 lm	1800 lm	132 lm/W	bianco / <i>white</i>
				BWU65540	4000 K	4790 lm	1865 lm	139 lm/W	bianco / <i>white</i>
			AS	BWU65450	3000 K	6240 lm	1630 lm	164 lm/W	bianco / <i>white</i>
			BWU65550	4000 K	6535 lm	1680 lm	171 lm/W	bianco / <i>white</i>	
48+24 W	2250 mm.	120°	BWU98440	3000 K	6125 lm	3590 lm	135 lm/W	bianco / <i>white</i>	
			BWU98540	4000 K	6330 lm	3720 lm	140 lm/W	bianco / <i>white</i>	
		AS	BWU98450	3000 K	8380 lm	3240 lm	161 lm/W	bianco / <i>white</i>	
		BWU98550	4000 K	8670 lm	3355 lm	167 lm/W	bianco / <i>white</i>		

⊕ IP40 L80-B10 / 60.000 h.

Segno Wall

moduli illuminanti / *lighting modules*

Parete Uplight / Downlight - Wall Mounted Uplight / Downlight

CRI > 90

doppia accensione - *dual switch*

modello <i>model</i>	versione <i>version</i>	lunghezza <i>length</i>	ottica <i>optic</i>	codice <i>code</i>	CCT <i>CCT</i>	lumen output		efficacia <i>efficacy</i>	colore <i>colour</i>
						downlight	uplight		
On / Off 220 ÷ 240 V	24+12 W	1131 mm.	120°	BWB47440	3000 K	3060 lm	1800 lm	135 lm/W	bianco / <i>white</i>
				BWB47540	4000 K	3170 lm	1865 lm	140 lm/W	bianco / <i>white</i>
			AS	BWB47450	3000 K	4190 lm	1630 lm	162 lm/W	bianco / <i>white</i>
			BWB47550	4000 K	4340 lm	1680 lm	167 lm/W	bianco / <i>white</i>	
	36+12 W	1691 mm.	120°	BWB65440	3000 K	4545 lm	1800 lm	132 lm/W	bianco / <i>white</i>
				BWB65540	4000 K	4790 lm	1865 lm	139 lm/W	bianco / <i>white</i>
			AS	BWB65450	3000 K	6240 lm	1630 lm	164 lm/W	bianco / <i>white</i>
			BWB65550	4000 K	6535 lm	1680 lm	171 lm/W	bianco / <i>white</i>	
	48+24 W	2250 mm.	120°	BWB98440	3000 K	6125 lm	3590 lm	135 lm/W	bianco / <i>white</i>
				BWB98540	4000 K	6330 lm	3720 lm	140 lm/W	bianco / <i>white</i>
			AS	BWB98450	3000 K	8380 lm	3240 lm	161 lm/W	bianco / <i>white</i>
			BWB98550	4000 K	8670 lm	3355 lm	167 lm/W	bianco / <i>white</i>	

⊕ IP40 L80-B10 / 60.000 h.

Altre alimentazioni / Other feedings

Per ordinare Segno, nella versione Parete Uplight / Downlight in doppia accensione con alimentazioni alternative rispetto allo standard On/Off, aggiungere al codice standard la sigla riportata nella tabella a fianco.

To order Segno dual switch Wall Mounted Uplight / Downlight version differently feeded from standard On / Off model, add the abbreviation shown in the opposite table to the standard code.

Versioni in emergenza per Casambi e Pan Digital su richiesta. Contattare l'Azienda.

Emergency versions with Casambi or Pan Digital feeding on request. Take contact with the Company.

	versione <i>version</i>	DALI	Dimm. Push (*)	Emerg. 1 h	Casambi	Pan Digital
uplight / downlight - single switch	12+4 W	\	\	\	\	\
	24+12 W	DA	PU	\	CA	PD
	36+12 W	DA	PU	H1	CA	PD
	48+24 W	DA	PU	H1	CA	PD
uplight / downlight - dual switch	24+12 W	\	\	\	\	\
	36+12 W	DA	PU	\	CA	PD
	48+24 W	DA	PU	\	CA	PD

(*) Massimo 4 moduli illuminanti. / (*) Up to 4 lighting modules.

Segno Trimless

design Daniele Monelli

Segno Trimless è un sistema per l'illuminazione lineare continua da incasso, installabile a filo del controsoffitto in modo semplice e rapido e mantenendo totalmente nascosto il bordo di battuta. Le operazioni di rasatura del soffitto si completano totalmente prima dell'installazione elettrica, che può quindi essere svolta in totale pulizia e in assenza di polvere.

Le versioni ad incasso trimless sono costituite da moduli strutturali che si montano su appositi telai da controsoffitto grazie ad un sistema di molle a scatto rapido "Click&Lock".

Segno Trimless is a system for continuous linear recessed lighting, which can be simply and fastly installed trimless. The ceiling finishing operations are completed before the electrical installation, which can be carried out in total cleanliness and without powder. The trimless recessed versions are made from structural modules that are installed on false ceiling frames thanks to the "Click & Lock" snap spring system.





Segno Trimless

Installazione - *installation*

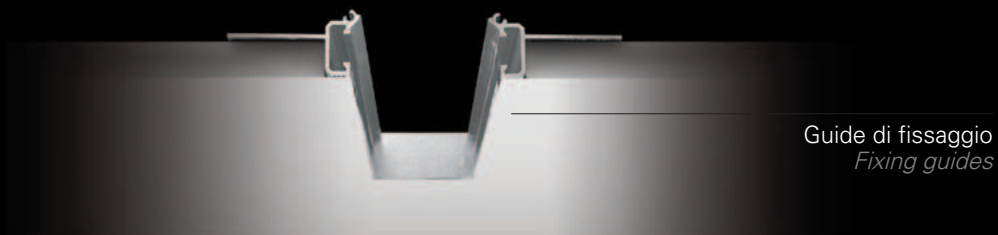

Click & Lock

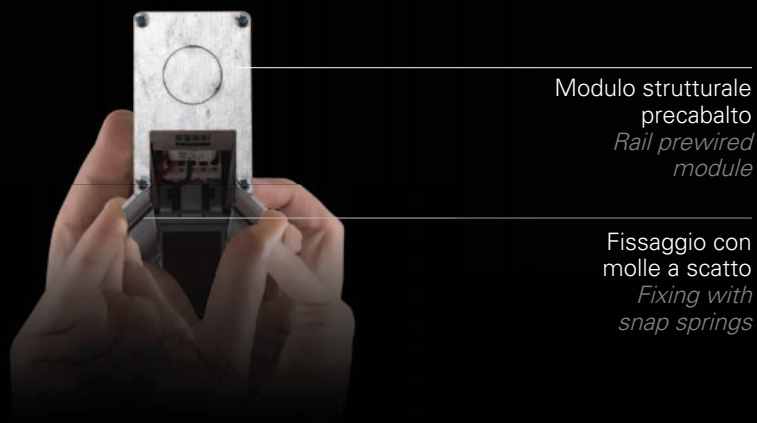

Click & Light

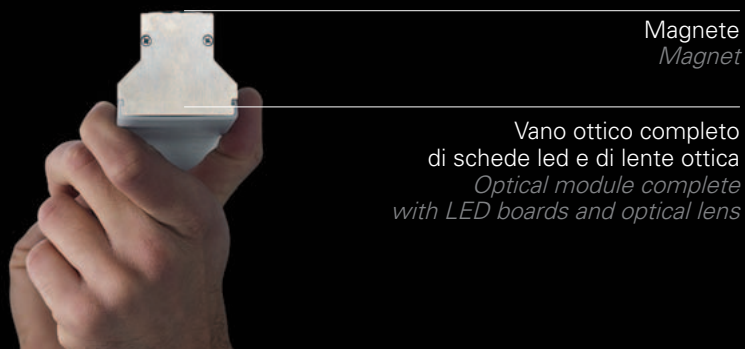

Installazione delle guide di fissaggio - *Fixing guides installation*

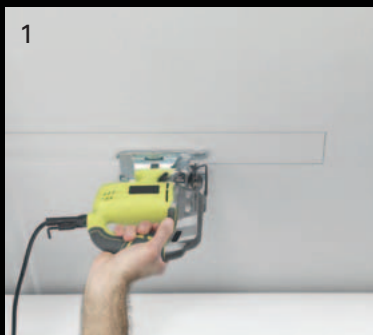

1 - Taglio del cartongesso
Plasterboard cutting

2 - Inserimento delle guide di fissaggio
(telaio preassemblato)
Inserting of fixing rails (pre-assembled frame)

3 - Fissaggio delle guide al cartongesso
Fixing of the rails to the plasterboard

4 - Stuccatura a filo e tinteggiatura finale
Trimless grouting and final painting



Installazione dei moduli ottici - *Optical modules installation*

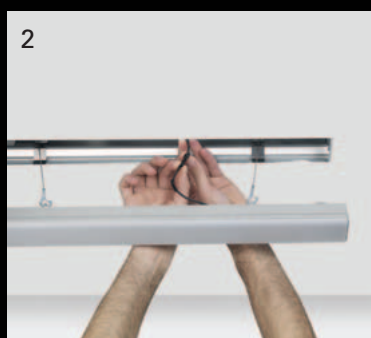
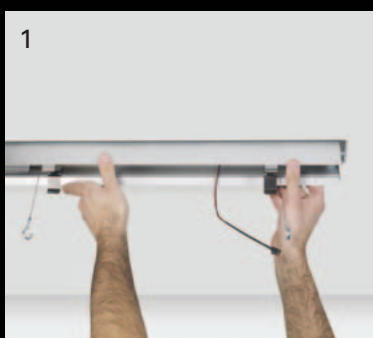

1 - Inserimento del modulo strutturale
a scatto e collegamento alla rete
*Insertion of the snap-in rail module
and connection to the mains*

2 - Fissaggio cavo di sicurezza con sistema
"grip-lock" e cablaggio fast-plug del modulo ottico
*Safety cable fixing with grip-lock system and
optical module fast-plug wiring*

3 - Inserimento del vano ottico a fissaggio
magnetico senza utensili
*Insertion of the optical compartment
with magnetic no tools fixing*

4 - Accensione finale
Turn it on

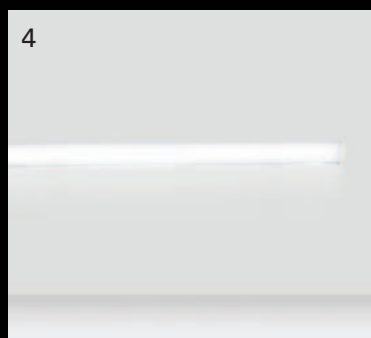

Segno Trimless

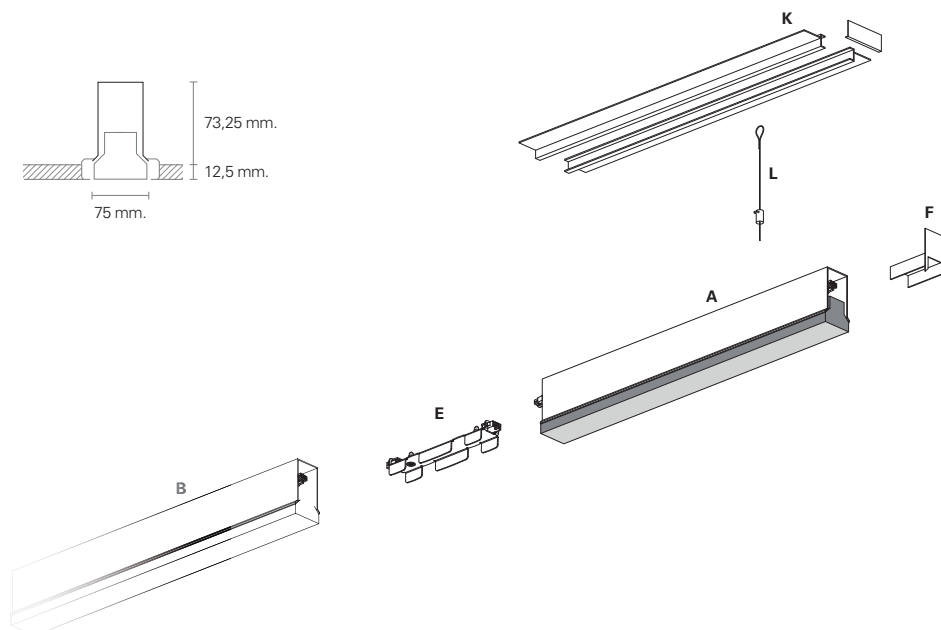

per comporre Segno System - to configure Segno System

- 1 Selezionare i moduli illuminanti e gli accessori di montaggio necessari
Select the lighting modules and mounting accessories needed
- 2 Per accensioni diverse dallo standard On/Off, specificare il tipo di alimentazione elettrica desiderata con l'apposita sigla alla fine del codice del modulo illuminante (verificare tabelle di fattibilità nelle pagine seguenti)
For ignitions different from the standard On/Off, specify the type of feeding desired with the appropriate abbreviation at the end of the code of the lighting module (also check the feasibility tables on the following pages)

alimentazioni - feeding

accensione feeding	note note	sigla da aggiungere sign to add
On / Off	per impianti con accensione On / Off, indicare il solo codice del modulo illuminante scelto (vedi le tabelle dei codici dei moduli illuminanti a pg. 188). <i>to feed switching On / Off, don't add any sign to the illuminating module (see code list of illuminating modules from pg. 188).</i>	/
DALI	aggiungere al codice del modulo illuminante la sigla DA per ordinare gli stessi con alimentazione DALI. <i>add sign DA to the code of the lighting modules to order itself in DALI version.</i>	DA
Push Dimmable	aggiungere al codice del modulo illuminante la sigla PU per ordinare gli stessi con alimentazione dimmerabile "Push". <i>add sign PU to the code of the lighting module to order itself in dimmable "Push" version.</i>	PU
Emergency 1 h.	aggiungere al codice del modulo illuminante la lettera H1 per ordinare gli stessi con alimentazione On / Off e completi di kit per emergenza permanente (accensione 0,5 sec. - 1 h. di autonomia). <i>add letters H1 to the lighting module to order On / Off feeding including permanent emergency kit (switch 0,5 secs - 1 h. autonomy).</i>	H1
Casambi	aggiungere al codice del modulo illuminante la lettera CA per ordinare gli stessi con alimentazione digitale Casambi. <i>add letters CA to the lighting module to order On / Off feeding including digital feeding Casambi.</i>	CA
Pan Digital	aggiungere al codice del modulo illuminante la lettera PD per ordinare gli stessi con alimentazione digitale Pan Digital. <i>add letters PD to the lighting module to order On / Off feeding including digital feeding Pan Digital.</i>	PD

per altri tipi di alimentazione contattare l'azienda. - *take contact with the company if other different configuration feeding are request.*

Per facilitare l'organizzazione dei lavori di cantiere è possibile ordinare i kit di montaggio separatamente, anticipandone la consegna rispetto ai moduli precablati. Una volta fissate al controsoffitto le guide in alluminio, i moduli precablati si inseriscono a scatto con il sistema "click & lock" (vedi pag. 184).

To facilitate the organization of site works, the assembly kits can be ordered separately, receiving them in advance of the pre-wired modules. Once the aluminum guides are fixed to the false ceiling, the prewired modules snap into place with the "click & lock" system (see page 184).

Moduli Segno Trimless- moduli precablati - *Segno Trimless Modules - wired modules*

riferimento reference	descrizione description	lunghezza length	peso weight	codice code
A	modulo lineare luminoso emissione downlight; monoaccensione; completo di sorgenti led + lente ottica o schermo diffusore; precablati e completo di connettori fast-plug; driver incluso. linear lighting module <i>downlighter; single switch; complete with led sources + lenses or diffuser; wired with fast plug connectors; driver included.</i>	573 mm.	2,25 kg.	vedi codici di tutte le versioni nelle tabella a pg. 188 <i>see table codes of all versions from pg. 188</i>
		1131 mm.	3,55 kg.	
		1691 mm.	4,45 kg.	
		2250 mm.	5,35 kg.	
B	modulo lineare non luminoso cover inferiore inclusa; completo di cablaggio passante e di connettori fast-plug; senza driver e senza sorgenti luminose. linear lighting module <i>bottom cover included; complete of passing wiring with fast plug connectors; without led and without driver.</i>	573 mm.	1,20 kg.	ATS07101
		1131 mm.	2,20 kg.	ATS07102
		1691 mm.	2,70 kg.	ATS07103

Accessori di montaggio - *Mounting accessories*

riferimento reference	descrizione description	lunghezza length	peso weight	codice code
E	giunto meccanico precablato completo di connettori fast-plug per la connessione elettrica dei moduli Segno. mechanical and electrical joint <i>wired with electrical fast plug to connect Segno modules.</i>	\	0,20 kg.	ATS07304
F	tappo terminale in acciaio zincato; spessore 1 mm.; solo per moduli Segno Trimless (1 pezzo). end cap <i>galvanized steel cap; 1 mm. tickness; only for Segno Trinless modules (1 piece).</i>	\	0,02 kg.	ATS07202
K	kit di montaggio kit di profili guida per l'installazione trimless in controsoffitti in gesso; completo di guide a misura in alluminio estruso, tappi terminali in metallo, staffe di fissaggio a scatto per l'alloggiamento dei moduli Segno. plaster mounting kit <i>guide profiles kit for trimless installation in plaster ceilings; guide in extruded aluminum, metal end caps, snap-in fixing bracket for housing Segno modules.</i>	573 mm.	0,45 kg.	ATS07205
		1131 mm.	0,82 kg.	ATS07206
		1691 mm.	1,22 kg.	ATS07207
		2250 mm.	1,65 kg.	ATS07208
L	cavo di sicurezza cavo con cappio in acciaio per l'aggancio al soffitto; completo di nipple per la regolazione della lunghezza del cavo di sicurezza: portata massima 60 kg. (1 pezzo). safety cable <i>steel cable with noose to attachment to the ceiling; complete with nipple for height adjustment; maximum weight strength 60 kg. (1 piece).</i>	2000 mm.	0,03 kg.	ATS05300

Segno Trimless

moduli illuminanti / *lighting modules*

Incasso Downlight - *Recessed Downlight*

CRI > 90

singola accensione - *single switch*

modello <i>model</i>	versione <i>version</i>	lunghezza <i>length</i>	ottica <i>optic</i>	codice <i>code</i>	CCT <i>CCT</i>	lumen output		efficacia <i>efficacy</i>	colore <i>colour</i>	
						downlight	uplight			
On / Off 220 ÷ 240 V	12W	573 mm.	60° / UGR<19	CTD16410	3000 K	2135 lm	-	178 lm/W	bianco / <i>white</i>	
				CTD16510	4000 K	2200 lm	-	183 lm/W	bianco / <i>white</i>	
			90°	CTD16420	3000 K	2070 lm	-	173 lm/W	bianco / <i>white</i>	
				CTD16520	4000 K	2140 lm	-	178 lm/W	bianco / <i>white</i>	
			120°	CTD16440	3000 K	1525 lm	-	127 lm/W	bianco / <i>white</i>	
				CTD16540	4000 K	1585 lm	-	132 lm/W	bianco / <i>white</i>	
		AS	CTD16450	3000 K	2095 lm	-	175 lm/W	bianco / <i>white</i>		
			CTD16550	4000 K	2160 lm	-	180 lm/W	bianco / <i>white</i>		
		SY	CTD16460	3000 K	2155 lm	-	180 lm/W	bianco / <i>white</i>		
			CTD16560	4000 K	2225 lm	-	185 lm/W	bianco / <i>white</i>		
		24W	1131 mm.	60° / UGR<19	CTD32410	3000 K	4260 lm	-	178 lm/W	bianco / <i>white</i>
					CTD32510	4000 K	4400 lm	-	183 lm/W	bianco / <i>white</i>
	90°			CTD32420	3000 K	4140 lm	-	173 lm/W	bianco / <i>white</i>	
				CTD32520	4000 K	4270 lm	-	178 lm/W	bianco / <i>white</i>	
	120°			CTD32440	3000 K	3050 lm	-	127 lm/W	bianco / <i>white</i>	
				CTD32540	4000 K	3165 lm	-	132 lm/W	bianco / <i>white</i>	
	AS		CTD32450	3000 K	4185 lm	-	174 lm/W	bianco / <i>white</i>		
			CTD32550	4000 K	4320 lm	-	180 lm/W	bianco / <i>white</i>		
	SY		CTD32460	3000 K	4305 lm	-	179 lm/W	bianco / <i>white</i>		
			CTD32560	4000 K	4445 lm	-	185 lm/W	bianco / <i>white</i>		
	36W		1691 mm.	60° / UGR<19	CTD48410	3000 K	6395 lm	-	178 lm/W	bianco / <i>white</i>
					CTD48510	4000 K	6600 lm	-	183 lm/W	bianco / <i>white</i>
		90°		CTD48420	3000 K	6205 lm	-	172 lm/W	bianco / <i>white</i>	
				CTD48520	4000 K	6410 lm	-	178 lm/W	bianco / <i>white</i>	
120°		CTD48440		3000 K	4575 lm	-	127 lm/W	bianco / <i>white</i>		
		CTD48540		4000 K	4745 lm	-	132 lm/W	bianco / <i>white</i>		
AS		CTD48450	3000 K	6270 lm	-	174 lm/W	bianco / <i>white</i>			
		CTD48550	4000 K	6470 lm	-	180 lm/W	bianco / <i>white</i>			
SY		CTD48460	3000 K	6455 lm	-	179 lm/W	bianco / <i>white</i>			
		CTD48560	4000 K	6665 lm	-	185 lm/W	bianco / <i>white</i>			
48W		2250 mm.	60° / UGR<19	CTD64410	3000 K	8520 lm	-	178 lm/W	bianco / <i>white</i>	
				CTD64510	4000 K	8800 lm	-	183 lm/W	bianco / <i>white</i>	
	90°		CTD64420	3000 K	8275 lm	-	172 lm/W	bianco / <i>white</i>		
			CTD64520	4000 K	8540 lm	-	178 lm/W	bianco / <i>white</i>		
	120°		CTD64440	3000 K	6095 lm	-	127 lm/W	bianco / <i>white</i>		
			CTD64540	4000 K	6320 lm	-	132 lm/W	bianco / <i>white</i>		
	AS	CTD64450	3000 K	8360 lm	-	174 lm/W	bianco / <i>white</i>			
		CTD64550	4000 K	8630 lm	-	180 lm/W	bianco / <i>white</i>			
	SY	CTD64460	3000 K	8605 lm	-	179 lm/W	bianco / <i>white</i>			
		CTD64560	4000 K	8885 lm	-	185 lm/W	bianco / <i>white</i>			

⊕ IP20 L80-B10 / 60.000 h.

Altre alimentazioni / *Other feedings*

Per ordinare Segno, nella versione Plafone Downlight monoaccensione con alimentazioni alternative rispetto allo standard On/Off, aggiungere al codice standard la sigla riportata nella tabella a fianco.

To order Segno single switch Ceiling Mounted Downlight version differently feeded from standard On / Off model, add the abbreviation shown in the opposite table to the standard code.

Versioni in emergenza per Casambi e Pan Digital su richiesta. Contattare l'Azienda.

Emergency versions with Casambi or Pan Digital feeding on request. Take contact with the Company.

	versione <i>version</i>	DALI	Dimm. Push (*)	Emerg. 1 h	Casambi	Pan Digital
downlight single switch	12W	\	\	\	\	\
	24W	DA	PU	\	CA	PD
	36W	DA	PU	H1	CA	PD
	48W	DA	PU	H1	CA	PD

(*) Massimo 4 moduli illuminanti. / (*) Up to 4 lighting modules.



Steel Covers



Le Steel Covers sono realizzate in acciaio inox fotostampato e permettono di rivestire i moduli di Karma e Segno personalizzando l'aspetto estetico dell'impianto di illuminazione. Si montano a scatto, senza utensili e senza che si debba entrare in contatto con le parti elettriche. Possono essere montate anche successivamente alla prima installazione e possono essere facilmente sostituite.

The Steel Covers are made of photo-stamped stainless steel inox and allow to cover the Karma e Segno modules, customizing the aesthetic appearance of the lighting system. Mount with a click, without tools and without coming into contact with the electrical parts.

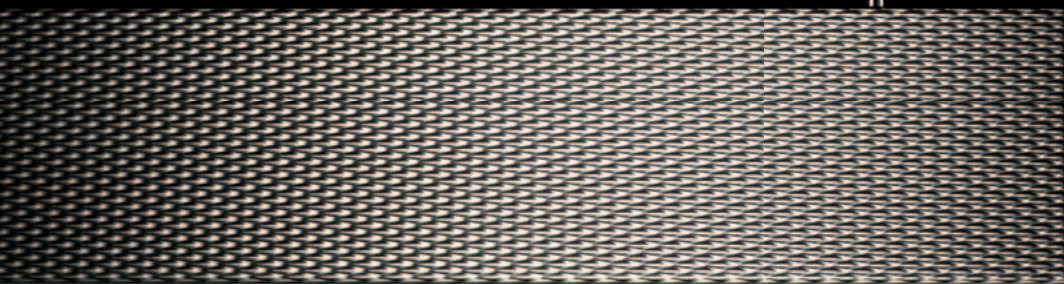
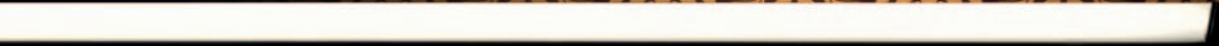

Accessori per Karma e Segno System

Karma and Segno System accessories



Il montaggio delle Steel Covers è a scatto e si effettua senza utensili. Le Steel Covers sono removibili, intercambiabili e si possono montare anche successivamente alla prima installazione. La lunghezza massima delle Steel Covers è di 1700 mm. I moduli di Karma e Segno più lunghi possono essere rivestiti con più lastre adiacenti.

Steel Covers assembly is snap-in and without tools. The Steel Covers are removable, interchangeable and can be mounted even after the first installation. The maximum length of Steel Covers is 1700 mm. Karma and Segno modules longer can be accessoried by adjoining more covers.

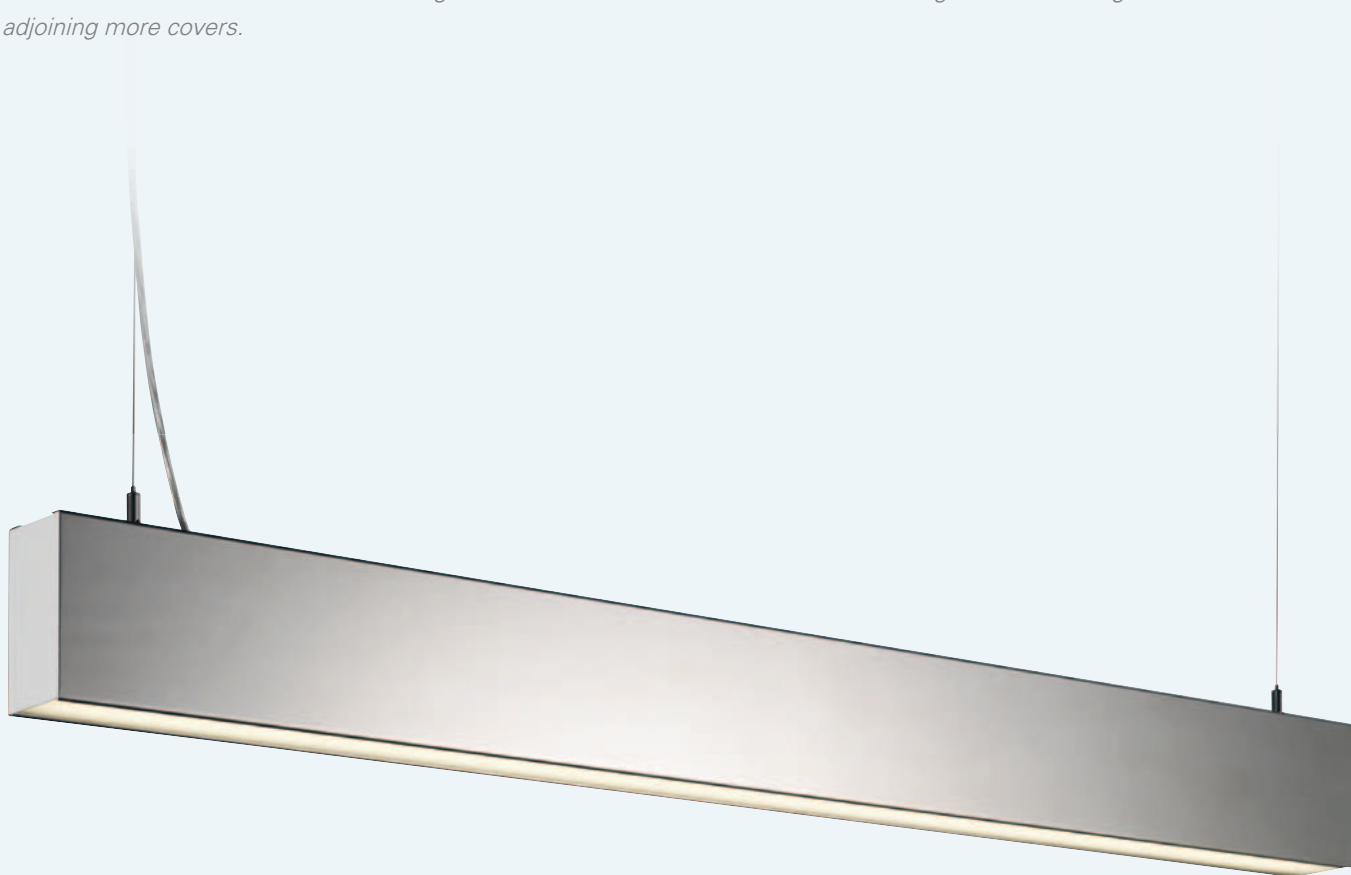



Mirror



Gold



Ocean



Bronze

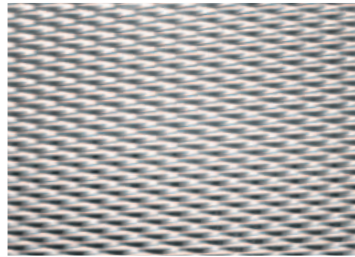

Wave



Stretch

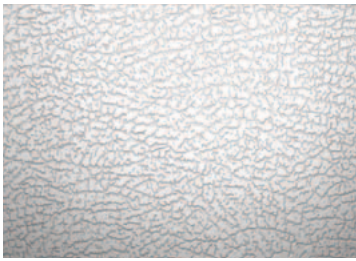

Skin

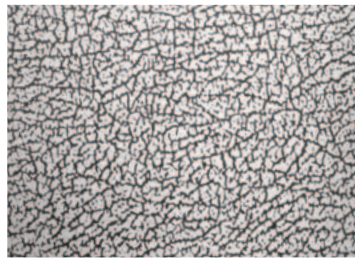

Dark Skin



Dubai

I kit per lunghezze fino a 1700 mm. prevedono una coppia di cover e una coppia di tappi terminali in plastica di colore nero.
I kit per lunghezze superiori a 1700 mm. prevedono due coppie di cover e una coppia di tappi terminali in plastica di colore nero.

*One couple of Steel Cover and one couple of end cap in black plastic are included in the kits for module up to 1700 mm. length.
Two couples of Steel Cover and one couple of end cap in black plastic are included in the kits for module over 1700 mm. length.*

Steel Covers Kits

serie - series	per moduli Karma - for Karma modules			per moduli Segno System - for Segno System modules			
	1140 mm.	1700 mm.	2260 mm.	573 mm.	1131 mm.	1691 mm.	2250 mm.
lunghezza modulo - length module							
Mirror	SCK11401	SCK17001	SCK22601	SCS05701	SCS11301	SCS16901	SCS22501
Gold	SCK11402	SCK17002	SCK22602	SCS05702	SCS11302	SCS16902	SCS22502
Ocean	SCK11403	SCK17003	SCK22603	SCS05703	SCS11303	SCS16903	SCS22503
Bronze	SCK11404	SCK17004	SCK22604	SCS05704	SCS11304	SCS16904	SCS22504
Wave	SCK11405	SCK17005	SCK22605	SCS05705	SCS11305	SCS16905	SCS22505
Stretch	SCK11406	SCK17006	SCK22606	SCS05706	SCS11306	SCS16906	SCS22506
Skin	SCK11407	SCK17007	SCK22607	SCS05707	SCS11307	SCS16907	SCS22507
Dark Skin	SCK11408	SCK17008	SCK22608	SCS05708	SCS11308	SCS16908	SCS22508
Dubai	SCK11409	SCK17009	SCK22609	SCS05709	SCS11309	SCS16909	SCS22509

Rimuovere sempre le pellicole protettive solo al termine dei lavori.
Nelle versioni a plafone applicare le Steel Covers prima di completare l'installazione.

*Always remove the protective films after completing the installation.
In the ceiling-mounted versions, apply the Steel Covers before completing the mounting to the ceiling.*

Karma / Segno System

Ricambi / Spare Parts

Moduli Ottici - Optic Modules

Ricambi - Spare Parts

CRI > 90

versione version	lunghezza length	ottica optic	codice code	CCT CCT	flusso lumen output
16W	573 mm.	120°	RTS16394	3000 K	1465 lm
			RTS16494	4000 K	1520 lm
		90°	RTS16392	3000 K	1990 lm
			RTS16492	4000 K	2055 lm
		60° / UGR<19	RTS16391	3000 K	2050 lm
			RTS16491	4000 K	2115 lm
	AS	RTS16395	3000 K	2010 lm	
		RTS16495	4000 K	2075 lm	
	SY	RTS16396	3000 K	2070 lm	
		RTS16496	4000 K	2135 lm	

32W	1131 mm.	120°	RTS32394	3000 K	2930 lm
			RTS32494	4000 K	3040 lm
		90°	RTS32392	3000 K	3980 lm
			RTS32492	4000 K	4105 lm
		60° / UGR<19	RTS32391	3000 K	4095 lm
			RTS32491	4000 K	4230 lm
	AS	RTS32395	3000 K	4020 lm	
		RTS32495	4000 K	4150 lm	
	SY	RTS32396	3000 K	4135 lm	
		RTS32496	4000 K	4270 lm	

Moduli Ottici - Optic Modules

Ricambi - Spare Parts

CRI > 90

versione version	lunghezza length	ottica optic	codice code	CCT CCT	flusso lumen output
48 W	1691 mm.	120°	RTS48394	3000 K	4395 lm
			RTS48494	4000 K	4560 lm
		90°	RTS48392	3000 K	5965 lm
			RTS48492	4000 K	6160 lm
		60° / UGR<19	RTS48391	3000 K	6145 lm
			RTS48491	4000 K	6345 lm
	AS		RTS48395	3000 K	6025 lm
			RTS48495	4000 K	6220 lm
	SY		RTS48396	3000 K	6205 lm
			RTS48496	4000 K	6405 lm

i moduli lunghezza 1691 mm. versione CRI>90 non possono sostituire i moduli lunghezza 1691 mm. versione CRI>80.
lighting modules length 1691 mm. CRI>90 cannot replace lighting modules length 1691 mm. CRI>80.

64 W	2250 mm.	120°	RTS64394	3000 K	5860 lm
			RTS64494	4000 K	6075 lm
		90°	RTS64392	3000 K	7955 lm
			RTS64492	4000 K	8210 lm
		60° / UGR<19	RTS64391	3000 K	8190 lm
			RTS64491	4000 K	8460 lm
	AS		RTS64395	3000 K	8035 lm
			RTS64495	4000 K	8295 lm
	SY		RTS64396	3000 K	8270 lm
			RTS64496	4000 K	8540 lm

i moduli lunghezza 2250 mm. versione CRI>90 non possono sostituire i moduli lunghezza 2250 mm. versione CRI>80.
lighting modules length 2250 mm. CRI>90 cannot replace lighting modules length 2250 mm. CRI>80.

Incassati

Recessed



Egon

p.200



Nemo Adj/Fix

p.218



Nemo Comfort

p.242



Nemo TL Adj/Fix

p.256



Nemo TL Comfort

p.264



Nemo IP54

p.270



Widot

p.276



Widot AS

p.282



Moby

p.286



Accent

p.296



Bobby
p.302



Jango
p.308



Show IP65
p.312



Shop
p.316



Single
p.320



Turn
p.321



Focus
p.322



Pill
p.326



Microled - Miniled
p.328



Odino
p.334



Song
p.334

Gesso
Plaster



Ettore
p.336

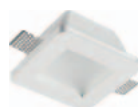

Enea
p.336

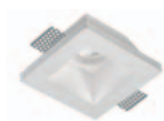

Priamo
p.337

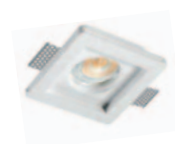

Paride
p.338

Egon





Egon



UP TO

97 lm / W

L80 / B20 50.000 h.



3 YEARS
WARRANTY

Equipaggiati con LED SMD di prima marca e con schermo diffondente, gli incassati Egon sono la soluzione ideale per ottenere effetti di luce morbida e diffusa. Grazie ad una completa gamma e al grado di protezione IP54 del vano ottico, gli incassi Egon sono ideati per l'illuminazione generale di tutti i tipi di ambiente. La serie di anelli per il retrofit li rende particolarmente indicati anche per la sostituzione dei tradizionali downlights a lampade fluorescenti compatte. Egon è garantito 5 anni con un lifetime L80-B20 / 50.000 h.

Equipped with first brand SMD LEDs and with a diffusing screen, Egon recessed are the ideal solution for obtaining soft and diffused light effects. Thanks to a complete range and IP54 bottom side protection degree, Egon recessed luminaires are suitable for general lighting of all types of environments. The series of rings for the retrofit makes them particularly suitable for the replacement of traditional downlights with compact fluorescent lamps. 5 years warranty; lifetime L80-B20 / 50.000 h.



- Alimentazione 220÷240 V / 50÷60 Hz - Classe "II"
- Installabile in controsoffitti con sistema di fissaggio rapido
- Accensione On / Off – Dimmerabile DALI / PUSH / 1...10 V / Casambi / Digital BLL / Emergenza 1h. e 3h.
- Installazione in controsoffitti con spessori da 5 mm. a 25 mm.
- Colore dell'anello decorativo bianco opaco.
- IP54 vano ottico; IP20 vano incassato
- led SMD 3000 K e 4000 K con resa cromatica CRI > 80
- No UV, No IR
- Emissioni luminose da 1350 lm a 2710 lumen
- Efficienza luminosa fino a 97 lm/W
- Efficienza energetica A
- Lifetime L80 / B20 – 50.000 h.
- Ottiche da 90°
- Temperatura ambiente di esercizio da -20°C a +45°C
- Certificazione CE, RoHS
- 3 anni di garanzia

- *Recessed with remote driver included. Feeding 220÷240 V / 50÷60 Hz- Class "II"*
- *False ceiling mounting with rapid system*
- *Switching On / Off – Dimm. DALI / PUSH / 1...10 V / Casambi / Digital BLL / Emergency 1h. or 3h.*
- *Mounting on false ceiling depth from 5 mm. up to 25 mm.*
- *Decorative frame colour matt white*
- *IP54 down; IP20 up*
- *led SMD 3000 K e 4000 K; CRI > 80*
- *No UV, No IR*
- *Light output from 1350 lm up to 2710 lm*
- *Efficacy up to 97 lm/W*
- *Energy Label A*
- *Lifetime L80 / B20 – 50.000 h.*
- *Optics and 90°*
- *Operation -20°C a +45°C*
- *Declaration CE, RoHS*
- *Warranty 3 years*

Egon

Dimensioni / Dimensions

15 W

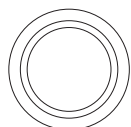

ø162

Ⓛ ø145 mm. 0,65

23 W

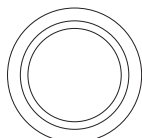
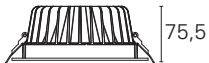

ø193

Ⓛ ø165 mm. 0,90

29 W

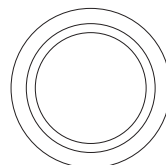

ø230

Ⓛ ø200 mm. 1,25

Ottiche / Optics

90°- 4000 K

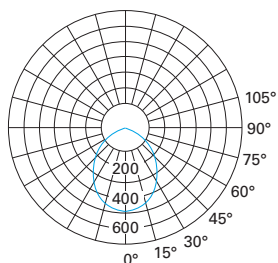

— C0-C180
— C90-C270

	15 W	23 W	29 W
1.0	9	703	1117
1.5	8	312	496
2.0	8	176	279
2.5	7	112	179
3.0	7	78	124
h (m)	d (m)	E ₀ (lx)	

Accessori / Accessories

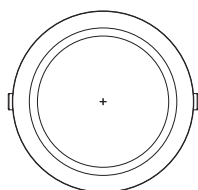

ø235

Ⓛ ø195/220 mm. 0,31



descrizione
description

codice
code

Anello adattatore per retrofit: permette di installare Egon nella versione 23 W da Ø 193 mm. in un foro compreso fra Ø 195 mm e Ø 220 mm.

Retrofit adaptor ring; it allows to install Egon 23 W model Ø 193 mm. in a hole cut from Ø 195 mm. to Ø 220 mm.

GLT14900

Egon

CRI > 80

versione version	dimensione size	potenza power	codice code	CCT CCT	flusso apparecchio lumen output	UGR UGR	ottica optic	colore colour
On / Off 220 ÷ 240 V	Ø 162 mm.	15 W	GLT14110	3000 K	1349 lm	< 22	90°	bianco / white
			GLT14120	4000 K	1410 lm	< 22	90°	bianco / white
	Ø 193 mm.	23 W	GLT14210	3000 K	2170 lm	< 22	90°	bianco / white
			GLT14220	4000 K	2241 lm	< 22	90°	bianco / white
	Ø 230 mm.	29 W	GLT14310	3000 K	2619 lm	< 22	90°	bianco / white
			GLT14320	4000 K	2713 lm	< 22	90°	bianco / white

Versioni dimmerabili / Dimmable versions

con regolazione via cavo
wired dimmable

versioni version	suffisso codice code suffix	nota note	esempio example
Push 1...10 V	DM	per ordinare la versione PUSH / 1...10 V aggiungere DM alla fine del codice to order the PUSH / 1...10 V version add DM to the end of the code	GLT-----DM
DALI	DA	per ordinare la versione DALI aggiungere DA alla fine del codice to order the DALI version add DA to the end of the code	GLT-----DA

con controllo della luce wireless Bluetooth
wireless Bluetooth lighting control

versioni version	suffisso codice code suffix	nota note	esempio example
PAN Digital	PD	per ordinare la versione per smart application PAN Digital aggiungere PD alla fine del codice to order the version for smart application PAN Digital add PD to the end of the code	GLT-----PD
CASAMBI	CA	per ordinare la versione per smart application CASAMBI aggiungere CA alla fine del codice to order the version for smart application CASAMBI add CA to the end of the code	GLT-----CA

versioni Bluetooth per "smart application"; vedi dettagli alle pagine 8 - 9
Bluetooth versions for "smart application"; see details to pages 8 - 9

Kit Emergenza / Emergency Kit

autonomia operation time	tempo di accensione switching time	tempo di ricarica recharging time	foro di incasso minimo (*) minimum recessing hole (*)	IP IP	peso weight	codice code
1 ora / 1 hour	0,5 sec.	24 h.	Ø 75 mm.	IP20	0,43 kg	DRV9092
3 ora / 3 hour	0,5 sec.	24 h.	Ø 100mm.	IP20	0,88 kg	DRV9091

(*) per l'installazione in controsoffitto verificare la compatibilità con il foro di incasso; vedi dettagli a pagina 546
(* for installation in false ceiling check the compatibility with the recessing hole; see details to page 546)

Nemo Program

Il Programma Nemo comprende una vastissima gamma di downlights che permette di personalizzare l'apparecchio da incasso sia nelle sue caratteristiche funzionali sia nell'aspetto estetico, rendendolo adatto a tutti i progetti illuminotecnici.

Tutti i downlights sono equipaggiati con led CoB di ultima generazione, selezionati fra i più performanti ed in grado di assicurare efficacia e qualità cromatica in linea con le prescrizioni illuminotecniche più stringenti. Le sorgenti led sono abbinata a dissipatori opportunamente testati nel tempo, per garantire i lifetime dichiarati. Grazie alle lenti intercambiabili, tutte caratterizzate da trattamento superficiale microprismatico e filtro diffondente integrato, i moduli illuminanti permettono di ottenere effetti di luce morbidamente diffusi e privi di scattering cromatico. Il programma Nemo prevede, oltre ai driver per la tradizionale accensione on/off, tutte le alimentazioni dimmerabili più utilizzate oltre che le più recenti elettroniche digitali bluetooth per la gestione di impianti "point to point" o reti "mesh" da applicazione mobile. L'aspetto estetico dei downlights è personalizzabile grazie ai collari decorativi intercambiabili che si abbinano agli anelli strutturali tondi o quadrati in colore bianco o nero, oppure alle versioni trimless per cartongesso. Completano la gamma le versioni IP54 per le installazioni dove è richiesta l'impermeabilità del vano ottico.

The Nemo Program includes a very wide range of downlights that allows you to customize the recessed luminaire both in its functional characteristics and aesthetic appearance, making it suitable for all lighting projects.

All downlights are equipped with the latest generation of CoB LEDs, selected from among the best performing and capable of ensuring efficacy and chromatic quality suitable with the most stringent lighting requirements. The LED sources are combined with heatsinks suitably tested over time, to guarantee the declared lifetime. Thanks to the interchangeable lenses, all characterized by micro-prismatic surface treatment and integrated diffusing filter, the illuminating modules allow to obtain softly diffused light effects without chromatic scattering. The Nemo program provides, in addition to the drivers for the traditional on / off ignition, all the most used dimmable power feedings as well as the latest digital bluetooth electronics for the management of "point to point" systems or "mesh" networks from mobile application. The aesthetic aspect of the downlights can be customized thanks to the interchangeable decorative collars that combine with the round or square structural rings in white or black, or with the trimless versions for plasterboard. The range is completed by IP54 versions for installations where waterproofing of the optical compartment is required.



Nemo Program – Overview / *Overview*

Gli incassi della serie Nemo sono realizzati nelle configurazioni con ottica fissa, orientabile o ad elevato comfort visivo. Queste configurazioni sono disponibili sia con anello tondo sia con anello quadrato, entrambi in colore in bianco opaco o nero opaco. Completano la gamma le versioni trimless per l'installazione in controsoffitti in cartongesso e le versioni con vetro di protezione per vano ottico IP54.

Tondo / *Rounded*

Adj



white



black



trimless

Fix



white



black



trimless

Comfort



white



black



trimless

IP54



white

The recessed luminaires of the Nemo series are made in configurations with fixed, adjustable or high visual comfort optics. These configurations are available with both rounded and squared rings, in matt white or matt black color. The range is completed by models for trimless installation for plaster ceilings and models with protective glass IP54 for the optical compartment.

Quadrato / Squared



white



black

Models 10 / 15 / 24 / 33 / 42 W
 Light Beams 15° / 24° / 38° / 55°
 Cut-Off 38°
 IP40
 Adjustable Optics - rotation 350° / aiming 30° max
 Ring: white / nero / trimless
 Collars: Matt Silver / Matt White / Mirror / Titanium / Gold



white



black

Models 10 / 15 / 24 / 33 / 42 W
 Light Beams 15° / 24° / 38° / 55°
 Cut-Off 38°
 IP40
 Fixed Optics
 Ring: white / nero / trimless
 Collars: Matt Silver / Matt White / Mirror / Titanium / Gold



white



black

Models 10 / 15 / 24 / 33 / 42 W
 Light Beams 15° / 24° / 38° / 55°
 Cut-Off 48°
 IP40
 High Visual Comfort Optics
 Ring: white / nero / trimless
 Collars: Matt Silver / Matt White / Matt Black / Matt Bronze



white

Models 10 / 15 W
 Light Beams 15° / 24° / 38°
 IP54
 Adjustable Optics - rotation 350° / aiming 30° max
 High Visual Comfort Optics
 Ring: white
 Prismatic Glass Diffuser











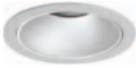













Nemo Program – Collari decorativi / *Decorative collars*

I downlights delle serie Adj, Fix e Comfort sono completi di specifici collari decorativi che, abbinandosi all'anello strutturale bianco, nero o trimless, possono personalizzare la parte visibile dell'apparecchio una volta installato.

Tutte i modelli della serie Adj, Fix e Comfort possono essere equipaggiati con collari in finitura Matt Silver e Matt White.























Ulteriori versioni dei collari decorativi sono in finitura lucida Titanium o Gold per le serie Adj e Fix, mentre la serie Comfort si completa con le finiture satinate Matt Black e Matt Bronze. Tutti i collari decorativi non influiscono né sulla temperatura di colore della luce emessa dalla sorgente led, né sul fascio principale di luce controllato direttamente dalla lente ottica, garantendo quindi l'intercambiabilità nel tempo a parità di effetto luminoso.

Tutti i collari decorativi sono disponibili anche come ricambi (vedi pag. 284)

		Adj / Fix				
		matt silver	matt white	mirror	titanium	gold
Tondo <i>Rounded</i>	anello bianco <i>white ring</i>					
	anello nero <i>black ring</i>					
	versione trimless <i>trimless version</i>					
Quadrato <i>Squared</i>	anello bianco <i>white ring</i>					
	anello nero <i>black ring</i>					

The downlights of the Adj, Fix and Comfort series are with specific decorative collars included which, by combining with the white, black or trimless structural ring, customize the appearance of the recessed luminaires once installed. All models of the Adj, Fix and Comfort series can be equipped with collars in Matt Silver and Matt White finish. Further versions of the decorative collars are available in glossy Titanium or Gold finish for the Adj and Fix series, and the Comfort series is completed with the Matt Black and Matt Bronze finishes. All the decorative collars do not influence neither the color temperature of the light emitted by the led source, nor the main beam of light controlled directly by the optical lens, allowing the interchangeability of the collars with neither influence on the luminous effect also after the first installation.

All decorative collars are also available as spare parts (see page 284)

Comfort				IP54
matt silver	matt white	matt black	matt bronze	prismatic glass
				
				
				
				
				

Nemo Program

Ottiche / Optics

Tutti gli incassi del programma Nemo sono dotati di lenti ottiche che, grazie al trattamento superficiale microprismatizzato e al filtro diffondente integrato, emettono la luce in modo morbido e uniforme, migliorando la qualità dell'effetto luminoso.

Le ottiche nelle versioni Adj e Fix si caratterizzano per un cut-off di 38° che garantisce un elevato controllo dell'abbagliamento diretto;

le versioni Comfort hanno un cut-off di 48° che permette di ottenere il massimo del comfort visivo qualunque sia la direzione di osservazione.

Tutte le ottiche sono disponibili come ricambi (vedi pag. 285)

All the recessed fixtures in the Nemo program are equipped with optical lenses which, thanks to its surface micro-prism and the integrated diffuser filter, emit the light in a soft and uniform way, ensuring the best quality of the light effect.

The optics in the Adj and Fix versions are characterized by a 38 ° cut-off which guarantees a high control of direct glare; the Comfort versions have a 48 ° cut-off that allows to obtain maximum visual comfort from any direction of observation.

All the optic lenses are available as spare parts (see pag. 285)

UGR < 17
UGR < 19
UGR < 21

I valori di UGR sono riportati nelle tabelle tecniche per ogni singolo codice
The UGR values are shown in the technical tables for each individual code

15°

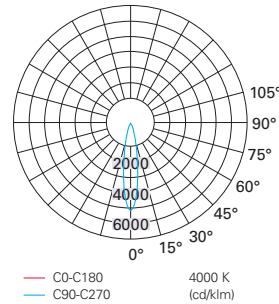

h (m)	d (m)	E ₀ (lx/klm)
1	0,3	5252
2	0,6	1313
3	0,9	584
4	1,2	328
5	1,5	210

24°

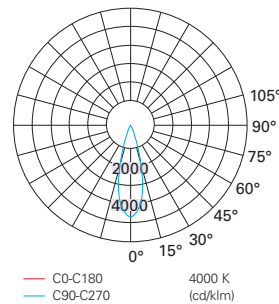

h (m)	d (m)	E ₀ (lx/klm)
1	0,4	4855
2	0,9	1214
3	1,3	539
4	1,7	303
5	2,2	194

38°

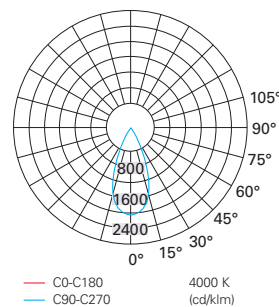

h (m)	d (m)	E ₀ (lx/klm)
1	0,7	2034
2	1,4	509
3	2,1	226
4	2,8	127
5	3,5	81

55°

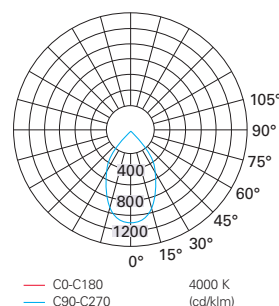

h (m)	d (m)	E ₀ (lx/klm)
1	1	1172
2	1,9	293
3	2,9	130
4	3,9	73
5	4,8	47

Adj

Fix

Comfort

IP54

cut off 38°

cut off 38°

cut off 48°

diffuser

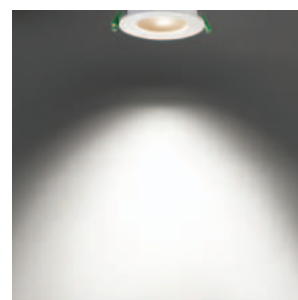
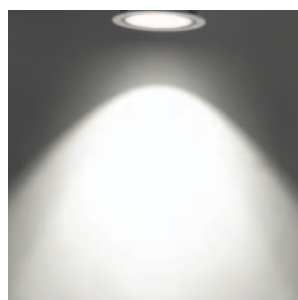
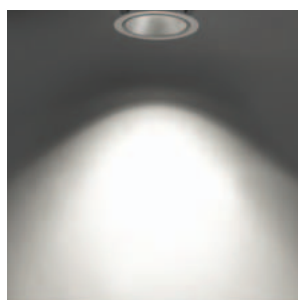
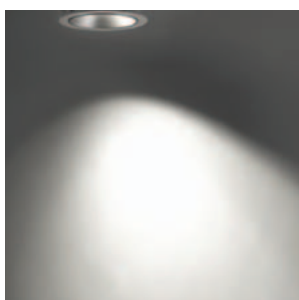
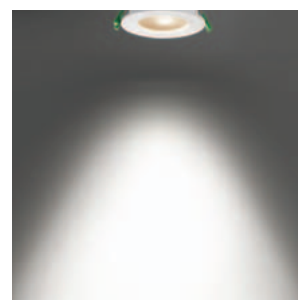
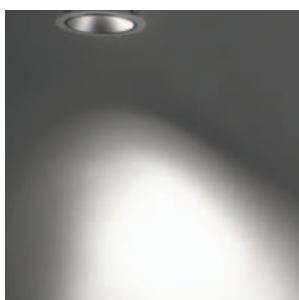
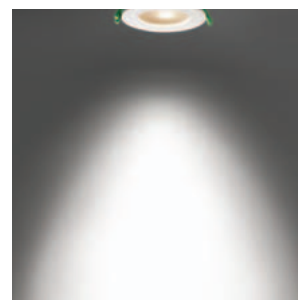
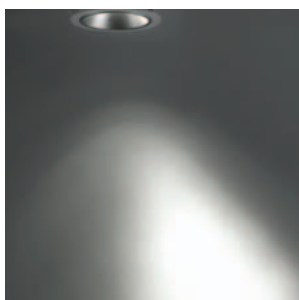
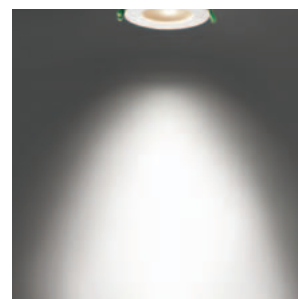
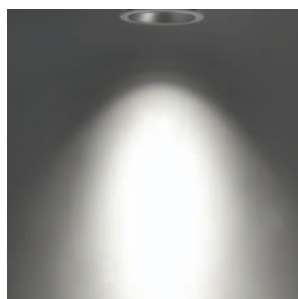
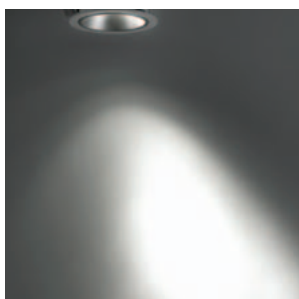

Nemo Program

Resa cromatica / *Color rendering*

CRI

R1 - R15

3000 K
CRI: 90,8

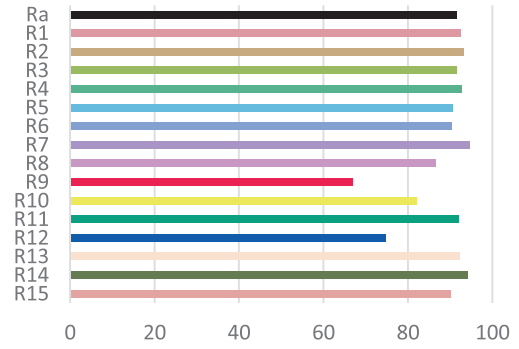
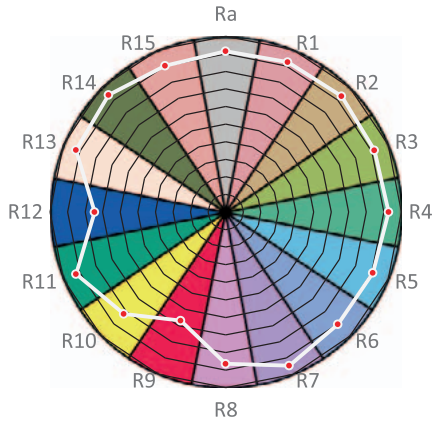

3000 K
CRI: 91,7

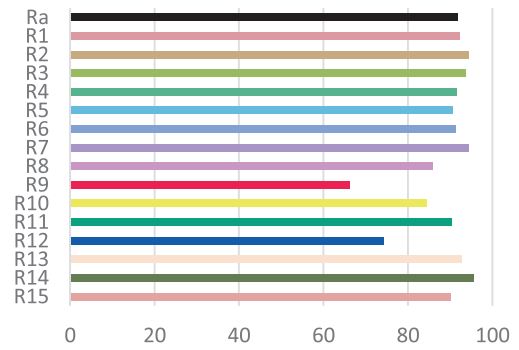
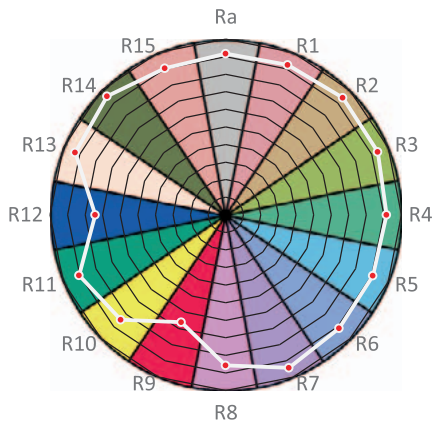

4000 K
CRI: 91,1

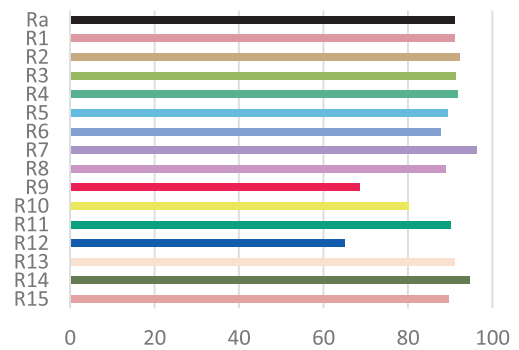
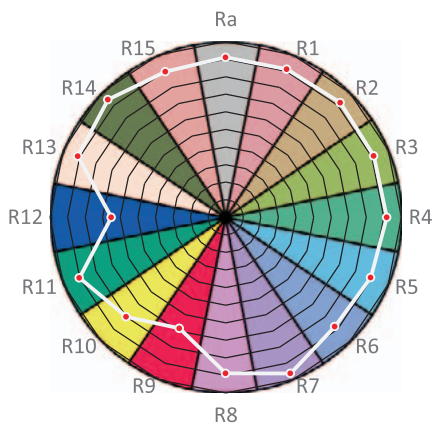

TM-30

Rf / Rg plot

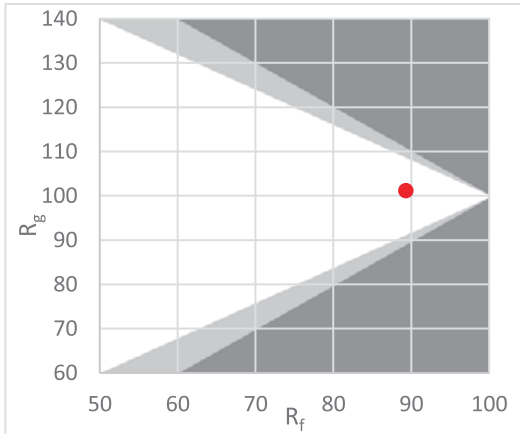

Rf 89,3
Rg 101,2

Color vector graphic

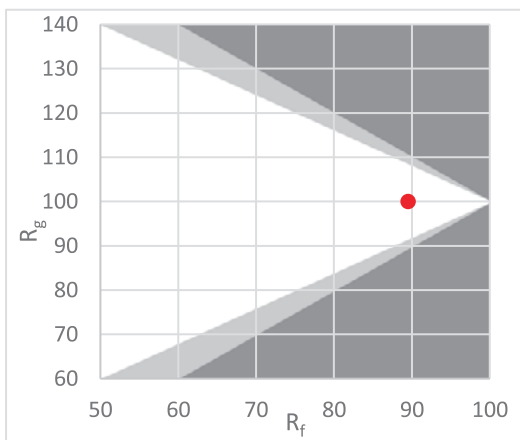
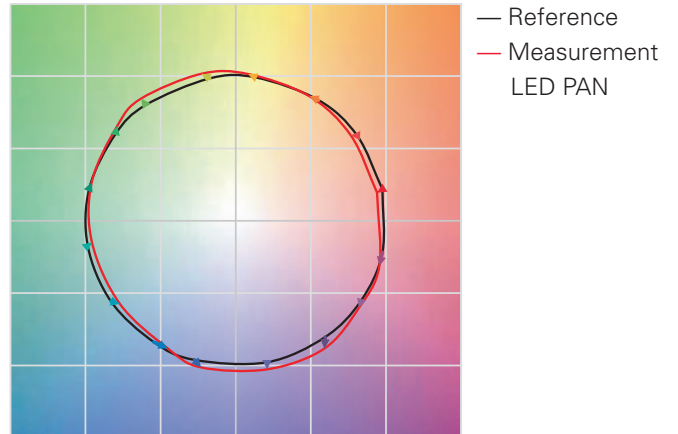

Rf 89,5
Rg 100,0

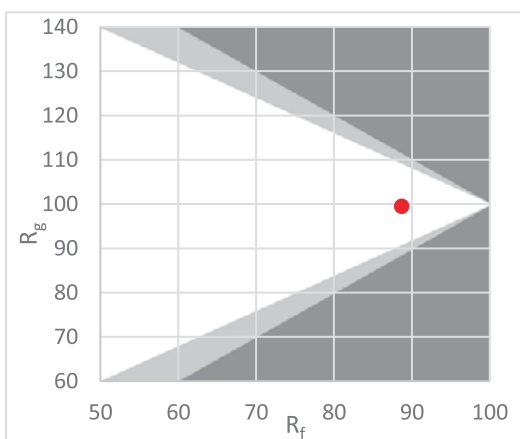
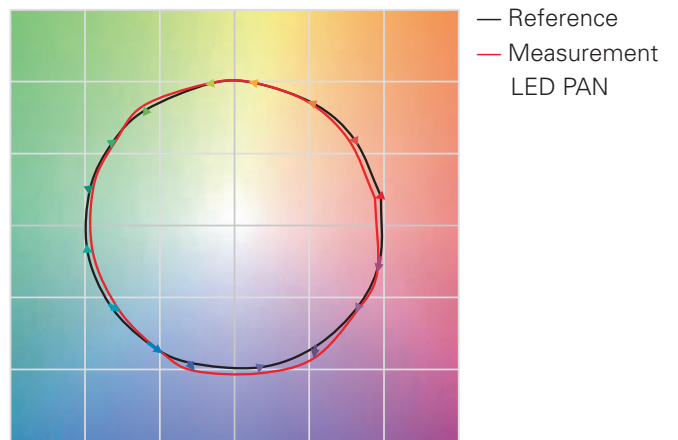

Rf 88,7
Rg 99,5

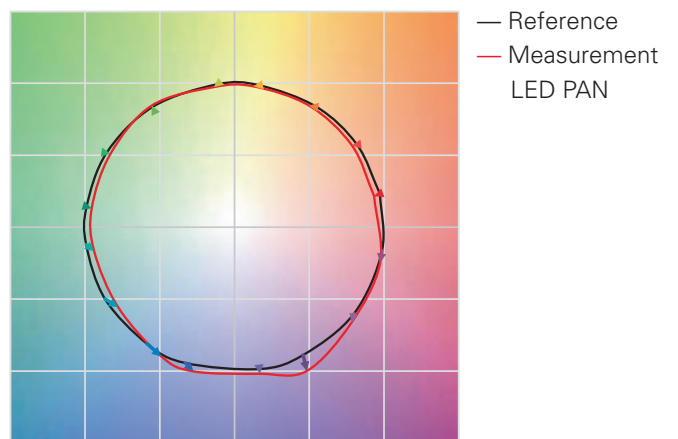

Nemo Program

Caratteristiche / Features

Declinati in cinque diverse potenze, tutti i moduli ottici degli apparecchi del Programma Nemo presentano le medesime caratteristiche delle sorgenti led, assicurando la stessa qualità cromatica della luce anche in progetti caratterizzati dall'impiego di diverse versioni di Nemo.

A parità di potenza, le dimensioni dei fori di incasso sono le medesime fra tutti i modelli Nemo, facilitando le operazioni di cantiere e il dimensionamento del progetto.

Available in five different powers and lumen output, all the optical modules of the Nemo Program luminaires have the same chromatic characteristics, thus ensuring lighting engineering consistency even in projects characterized by the application of different versions of Nemo.

Considering the same power and lumen output, the dimensions of the recessed holes are the same among all Nemo models, make easier the operation on site and deginn of the lighting project

	potenza power	10W	15W	24W	33W	42W
performance performance	flusso apparecchio lumen output	950 lumen	1450 lumen	2200 lumen	3100 lumen	3800 lumen
	lifetime lifetime	L80 / B20 - 50.000 h.				
cromaticità chromaticity	temperatura di colore light temperature	2700 K 3000 K 4000 K				
	CRI CRI	CRI > 90				
	MacAdam MacAdam	SDCM < 3				
versioni tonde rounded versions	foro di incasso hole size	Ø 75 mm.	Ø 75 mm.	Ø 100 mm.	Ø 125 mm.	Ø 150 mm.
	anello bezel size	Ø 85 mm.	Ø 85 mm.	Ø 112 mm.	Ø 140 mm.	Ø 165 mm.
versioni quadrate squared versions	foro di incasso hole size	75 x 75 mm.	75 x 75 mm.	100 x 100 mm.	125 x 125 mm.	150 x 150 mm.
	anello bezel size	85 x 85 mm.	85 x 85 mm.	112 x 112 mm.	140 x 140 mm.	165 x 165 mm.
versioni trimless trimless versions	foro di incasso hole size	Ø 76 mm.	Ø 76 mm.	Ø 100 mm.	Ø 122 mm.	Ø 142 mm.



Il programma Nemo prevede modelli installabili in ambienti dove è richiesta la protezione del vano ottico

The Nemo program includes models that can be installed in ambients where protection of the optical compartment is required.

Gli apparecchi del Programma Nemo sono dotati di mollette in acciaio armonico per una facile installazione in controsoffitti di spessore compreso fra 5 mm. e 25 mm.

All fixtures of the Nemo Program are equipped with harmonic steel clips for easy installation in false ceilings between from 5 mm to 25 mm thickness.



Tutti gli apparecchi del Programma Nemo sono dotati di plug a innesto rapido per il collegamento al driver senza utensili

All fixtures of the Nemo Program are equipped with a quick-fit plug for connection to the driver without tools.

Tutti gli apparecchi della serie Nemo sono dotati di apposito cavetto di sicurezza in acciaio che permette di assicurare il corpo dell'apparecchio al soffitto strutturale, evitando distacchi accidentali anche in caso di eventi sismici.

All the fixtures in the Nemo series are equipped with a special steel safety cable that allows to fix the luminaire body to the structural ceiling, avoiding accidental detachment even in case of seismic events.



Nemo Adj / Fix





Nemo Adj / Fix



Adj

Fix

☐ IP40 ^{UP TO} 100 lm / W L80 / B20 50.000h. CRI > 90 SDCM < 3   5 YEARS WARRANTY

Quattro aperture di fascio con cut-off di 38° e versioni fino a UGR<17 permettono di ottenere il giusto equilibrio fra controllo delle luminanze e diffusione della luce. I moduli illuminanti sono tutti equipaggiati con led di ultima generazione con CRI > 90 e SDCM < 3. I collari decorativi intercambiabili disponibili in cinque diverse finiture estetiche permettono di caratterizzare l'impianto anche successivamente alla prima installazione. Il cavetto di sicurezza in dotazione evita la caduta accidentale e il sistema di connessione al driver di tipo "fast plug" permette un'installazione rapida e sicura. Versione Nemo ADJ per luce di accento con orientabilità di 350° sul piano orizzontale e di 30° sul piano verticale. Nemo Fix per l'illuminazione verticale per il controllo dell'abbagliamento diretto e luce sfumata ai bordi del fascio.

Four beam openings with 38 ° cut-off and versions up to UGR <17 allow to obtain the right balance between luminance control and light diffusion. The lighting modules are all equipped with the latest generation of LEDs (CRI> 90 and SDCM <3). The interchangeable decorative collars are available in five different aesthetic finishes and allow you to customize the system even after the first installation. The safety cable supplied prevents accidental fall and the "fast plug" connection system to the driver allows quick and safe installation. Nemo ADJ version for accent lighting is adjustable 350 ° on the horizontal plane and 30 ° on the vertical plane. Nemo Fix for vertical lighting to control direct glare and soft light at the edges of the beam.

- Alimentazione 220÷240 V / 50÷60 Hz - Classe "II"
- Driver remoto con connessione "fast plug"
- Alimentazioni: On / Off, Dimmerabile Multifunzione (Push / 1...10 V), DALI.
- Kit emergenza 1h / 3h. accessorio remoto.
- Versioni con controllo digitale "Casambi" o "Pan Digital System"
- Installazione in controsoffitti con spessori da 5 mm. a 25 mm.
- Cavetto di sicurezza incluso premontato
- Versioni fisse e orientabili: 350° rotazione orizzontale con stop e 90° inclinazione verticale
- Anello strutturale tondo e quadrato: colori bianco opaco e nero opaco.
- Collare decorativo intercambiabile disponibile in finiture Matt, Mirror, White, Titanium, Gold.
- IP40 vano ottico; IP20 vano incassato
- Led CoB 2700 K / 3000 K / 4000 K con resa cromatica CRI > 90 e MacAdam SDCM < 3
- No UV, No IR
- Emissioni luminose da 890 lm a 3880 lumen
- Efficacia luminosa fino a 100 lm/W
- Efficienza energetica A
- Lifetime L80 / B20 – 50.000 h
- Lenti ottiche da 15° / 24° / 38° / 55° intercambiabili (ricambi)
- Cut-off 38°
- UGR < 17 / < 19 / < 21
- Temperatura ambiente di esercizio da -20°C a +45°C
- Certificazione CE, RoHS
- 5 anni di garanzia

- *Feeding 220÷240 V / 50÷60 Hz - Class "II"*
- *Remote driver with "fast plug" connectors*
- *Switching: On / Off, Multifunction Dimmable (Push / 1... 10 V), DALI.*
- *Emergency Kit 1h / 3h as remote accessory.*
- *Digital Control Versions "Casambi" or "Pan Digital System"*
- *Mounting on false ceiling depth from 5 mm. up to 25 mm.*
- *Safe cable included pre-mounted*
- *Fixed and Adjustable versions: 350° horizontal rotation with stop, 90° vertical rotation*
- *Rounded or squared ring; color matt white or matt black.*
- *Decorative collars interchangeable and available in Matt, Mirror, White, Titanium, Gold finishing.*
- *IP40 down; IP20 up*
- *Led CoB 2700K / 3000 K / 4000 K; CRI > 90; MacAdam SDCM < 3*
- *No UV, No IR*
- *Light output from 880 lm up to 3880 lm*
- *Efficacy up to 100 lm/W*
- *Energy Label A*
- *Lifetime L80 / B20 – 50.000 h*
- *Optic lens 15° / 24° / 38° / 55° (interchangeable as accessory)*
- *Cut-off 38°*
- *UGR < 17 / < 19 / < 21*
- *Operating from -20°C up to +45°C*
- *Compliance CE, RoHS*
- *5 years warranty*

Nemo Adj / Fix

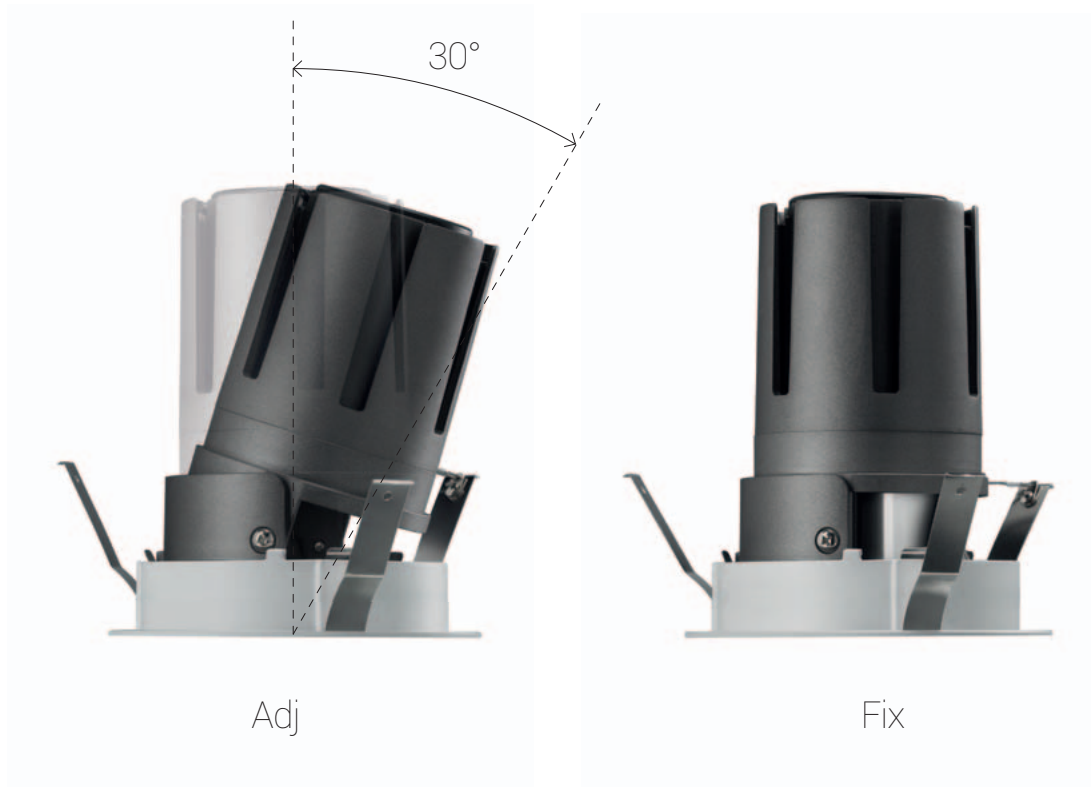

Versioni colore / Color versions

	collari decorativi / decorative collars				
	Satinata <i>Matt</i>	Speculare <i>Mirror</i>	Nero titanio <i>Titanium</i>	Oro lucido <i>Gold</i>	Bianco opaco <i>Matt white</i>
anello bianco <i>white ring</i>					
anello nero <i>black ring</i>					
anello bianco <i>white ring</i>					
anello nero <i>black ring</i>					

Dimensioni / Dimensions

Adj

Fix

Tondo / *Rounded*

Quadrato / *Squared*

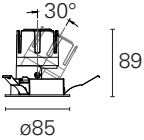
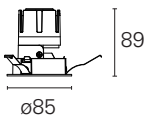
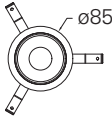
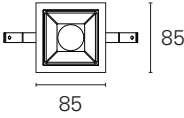
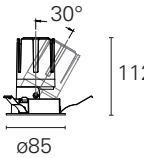
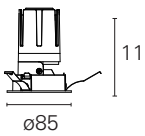
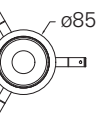
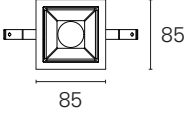
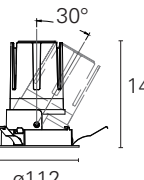
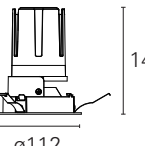
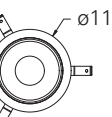
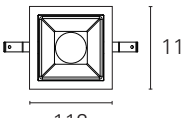
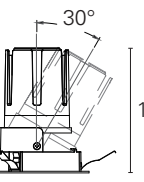
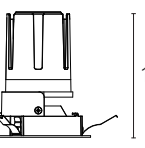
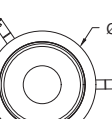
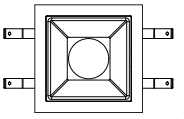
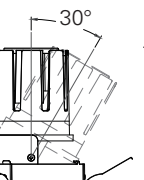
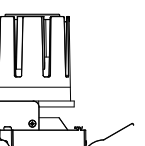
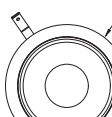
<p>10 W 920 lumen</p>	 <p>89 ø85</p> <p>kg 0,28</p>	 <p>89 ø85</p> <p>kg 0,28</p>	 <p>ø85</p> <p>⊕ ø75 mm.</p>	 <p>85</p> <p>⊕ ø75x75 mm.</p>
<p>15 W 1450 lumen</p>	 <p>112 ø85</p> <p>kg 0,36</p>	 <p>112 ø85</p> <p>kg 0,36</p>	 <p>ø85</p> <p>⊕ ø75 mm.</p>	 <p>85</p> <p>⊕ ø75x75 mm.</p>
<p>24 W 2200 lumen</p>	 <p>140 ø112</p> <p>kg 0,60</p>	 <p>140 ø112</p> <p>kg 0,60</p>	 <p>ø112</p> <p>⊕ ø100 mm.</p>	 <p>112</p> <p>⊕ ø100x100 mm.</p>
<p>33 W 3100 lumen</p>	 <p>169 ø140</p> <p>kg 1,05</p>	 <p>169 ø140</p> <p>kg 1,05</p>	 <p>ø140</p> <p>⊕ ø125 mm.</p>	 <p>140</p> <p>⊕ ø125x125 mm.</p>
<p>42 W 3800 lumen</p>	 <p>184 ø165</p> <p>kg 1,49</p>	 <p>184 ø165</p> <p>kg 1,49</p>	 <p>ø165</p> <p>⊕ ø150 mm.</p>	

Nemo Adj

anello bianco / *white ring*



Ottiche / Optics

vedi pg. 210 / *see pg. 210*

Ricambi / Spare parts

vedi pg. 284 / *see pg. 284*

Versioni dimmerabili / Dimmable versions

con regolazione via cavo
wired dimmable

versioni <i>version</i>	suffisso codice <i>code suffix</i>	nota <i>note</i>	esempio <i>example</i>
Push 1...10 V	DM	per ordinare la versione PUSH / 1...10 V aggiungere DM alla fine del codice <i>to order the PUSH / 1...10 V version add DM to the end of the code</i>	RTL-----DM
DALI	DA	per ordinare la versione DALI aggiungere DA alla fine del codice <i>to order the DALI version add DA to the end of the code</i>	RTL-----DA

con controllo della luce wireless Bluetooth
wireless Bluetooth lighting control

versioni <i>version</i>	suffisso codice <i>code suffix</i>	nota <i>note</i>	esempio <i>example</i>
PAN Digital	PD	per ordinare la versione per smart application PAN Digital aggiungere PD alla fine del codice <i>to order the version for smart application PAN Digital add PD to the end of the code</i>	RTL-----PD
CASAMBI	CA	per ordinare la versione per smart application CASAMBI aggiungere CA alla fine del codice <i>to order the version for smart application CASAMBI add CA to the end of the code</i>	RTL-----CA

versioni Bluetooth per "smart application"; **vedi dettagli alle pagine 8 - 9**
Bluetooth versions for "smart application"; see details to pages 8 - 9

Kit Emergenza / Emergency Kit

autonomia <i>operation time</i>	tempo di accensione <i>switching time</i>	tempo di ricarica <i>recharging time</i>	foro di incasso minimo (*) <i>minimum recessing hole (*)</i>	IP <i>IP</i>	peso <i>weight</i>	codice <i>code</i>
1 ora / 1 hour	0,5 sec.	24 h.	Ø 75 mm.	IP20	0,43 kg	DRV9092
3 ora / 3 hour	0,5 sec.	24 h.	Ø 100mm.	IP20	0,88 kg	DRV9091

(*) per l'installazione in controsoffitto verificare la compatibilità con il foro di incasso; **vedi dettagli a pagina 546**
() for installation in false ceiling check the compatibility with the recessing hole; see details to page 546*



CCT CCT	potenza power	ottica optic	flusso effettivo lumen output	UGR UGR	satinata matt	speculare mirror	nero titanio titanium	oro lucido gold	bianco opaco matt white
2700 K	10 W	15°	888 lm	≤ 19	RTL20141	RTL20241	RTL20341	RTL20441	RTL20541
		24°	894 lm	≤ 19	RTL20142	RTL20242	RTL20342	RTL20442	RTL20542
		38°	896 lm	≤ 19	RTL20143	RTL20243	RTL20343	RTL20443	RTL20543
		55°	899 lm	≤ 19	RTL20144	RTL20244	RTL20344	RTL20444	RTL20544
	15 W	15°	1359 lm	≤ 17	RTL20145	RTL20245	RTL20345	RTL20445	RTL20545
		24°	1363 lm	≤ 17	RTL20146	RTL20246	RTL20346	RTL20446	RTL20546
		38°	1371 lm	≤ 19	RTL20147	RTL20247	RTL20347	RTL20447	RTL20547
		55°	1383 lm	≤ 19	RTL20148	RTL20248	RTL20348	RTL20448	RTL20548
	24 W	15°	2056 lm	≤ 17	RTL20149	RTL20249	RTL20349	RTL20449	RTL20549
		24°	2058 lm	≤ 17	RTL20150	RTL20250	RTL20350	RTL20450	RTL20550
		38°	2064 lm	≤ 19	RTL20151	RTL20251	RTL20351	RTL20451	RTL20551
		55°	2070 lm	≤ 21	RTL20152	RTL20252	RTL20352	RTL20452	RTL20552
	33 W	15°	2938 lm	≤ 17	RTL20153	RTL20253	RTL20353	RTL20453	RTL20553
		24°	2946 lm	≤ 17	RTL20154	RTL20254	RTL20354	RTL20454	RTL20554
		38°	2954 lm	≤ 19	RTL20155	RTL20255	RTL20355	RTL20455	RTL20555
		55°	2960 lm	≤ 21	RTL20156	RTL20256	RTL20356	RTL20456	RTL20556
	42 W	15°	3678 lm	≤ 17	RTL20157	RTL20257	RTL20357	RTL20457	RTL20557
		24°	3684 lm	≤ 17	RTL20158	RTL20258	RTL20358	RTL20458	RTL20558
		38°	3690 lm	≤ 19	RTL20159	RTL20259	RTL20359	RTL20459	RTL20559
		55°	3696 lm	≤ 21	RTL20160	RTL20260	RTL20360	RTL20460	RTL20560
3000 K	10 W	15°	918 lm	≤ 19	RTL20101	RTL20201	RTL20301	RTL20401	RTL20501
		24°	924 lm	≤ 19	RTL20103	RTL20203	RTL20303	RTL20403	RTL20503
		38°	926 lm	≤ 19	RTL20105	RTL20205	RTL20305	RTL20405	RTL20505
		55°	930 lm	≤ 19	RTL20107	RTL20207	RTL20307	RTL20407	RTL20507
	15 W	15°	1408 lm	≤ 17	RTL20109	RTL20209	RTL20309	RTL20409	RTL20509
		24°	1412 lm	≤ 17	RTL20111	RTL20211	RTL20311	RTL20411	RTL20511
		38°	1420 lm	≤ 19	RTL20113	RTL20213	RTL20313	RTL20413	RTL20513
		55°	1432 lm	≤ 19	RTL20115	RTL20215	RTL20315	RTL20415	RTL20515
	24 W	15°	2150 lm	≤ 17	RTL20117	RTL20217	RTL20317	RTL20417	RTL20517
		24°	2152 lm	≤ 17	RTL20119	RTL20219	RTL20319	RTL20419	RTL20519
		38°	2158 lm	≤ 19	RTL20121	RTL20221	RTL20321	RTL20421	RTL20521
		55°	2164 lm	≤ 21	RTL20123	RTL20223	RTL20323	RTL20423	RTL20523
	33 W	15°	3032 lm	≤ 17	RTL20125	RTL20225	RTL20325	RTL20425	RTL20525
		24°	3040 lm	≤ 17	RTL20127	RTL20227	RTL20327	RTL20427	RTL20527
		38°	3048 lm	≤ 19	RTL20129	RTL20229	RTL20329	RTL20429	RTL20529
		55°	3054 lm	≤ 21	RTL20131	RTL20231	RTL20331	RTL20431	RTL20531
	42 W	15°	3780 lm	≤ 17	RTL20133	RTL20233	RTL20333	RTL20433	RTL20533
		24°	3786 lm	≤ 17	RTL20135	RTL20235	RTL20335	RTL20435	RTL20535
		38°	3792 lm	≤ 19	RTL20137	RTL20237	RTL20337	RTL20437	RTL20537
		55°	3798 lm	≤ 21	RTL20139	RTL20239	RTL20339	RTL20439	RTL20539
4000 K	10 W	15°	956 lm	≤ 19	RTL20102	RTL20202	RTL20302	RTL20402	RTL20502
		24°	958 lm	≤ 19	RTL20104	RTL20204	RTL20304	RTL20404	RTL20504
		38°	968 lm	≤ 19	RTL20106	RTL20206	RTL20306	RTL20406	RTL20506
		55°	974 lm	≤ 19	RTL20108	RTL20208	RTL20308	RTL20408	RTL20508
	15 W	15°	1486 lm	≤ 17	RTL20110	RTL20210	RTL20310	RTL20410	RTL20510
		24°	1494 lm	≤ 17	RTL20112	RTL20212	RTL20312	RTL20412	RTL20512
		38°	1500 lm	≤ 19	RTL20114	RTL20214	RTL20314	RTL20414	RTL20514
		55°	1502 lm	≤ 19	RTL20116	RTL20216	RTL20316	RTL20416	RTL20516
	24 W	15°	2210 lm	≤ 17	RTL20118	RTL20218	RTL20318	RTL20418	RTL20518
		24°	2218 lm	≤ 17	RTL20120	RTL20220	RTL20320	RTL20420	RTL20520
		38°	2226 lm	≤ 19	RTL20122	RTL20222	RTL20322	RTL20422	RTL20522
		55°	2234 lm	≤ 21	RTL20124	RTL20224	RTL20324	RTL20424	RTL20524
	33 W	15°	3116 lm	≤ 17	RTL20126	RTL20226	RTL20326	RTL20426	RTL20526
		24°	3120 lm	≤ 17	RTL20128	RTL20228	RTL20328	RTL20428	RTL20528
		38°	3128 lm	≤ 19	RTL20130	RTL20230	RTL20330	RTL20430	RTL20530
		55°	3134 lm	≤ 21	RTL20132	RTL20232	RTL20332	RTL20432	RTL20532
	42 W	15°	3842 lm	≤ 17	RTL20134	RTL20234	RTL20334	RTL20434	RTL20534
		24°	3858 lm	≤ 17	RTL20136	RTL20236	RTL20336	RTL20436	RTL20536
		38°	3864 lm	≤ 19	RTL20138	RTL20238	RTL20338	RTL20438	RTL20538
		55°	3878 lm	≤ 21	RTL20140	RTL20240	RTL20340	RTL20440	RTL20540

Nemo Adj

anello nero / *black ring*



Ottiche / Optics

vedi pg. 210 / *see pg. 210*

Ricambi / Spare parts

vedi pg. 284 / *see pg. 284*

Versioni dimmerabili / Dimmable versions

con regolazione via cavo
wired dimmable

versioni <i>version</i>	suffisso codice <i>code suffix</i>	nota <i>note</i>	esempio <i>example</i>
Push 1...10 V	DM	per ordinare la versione PUSH / 1...10 V aggiungere DM alla fine del codice <i>to order the PUSH / 1...10 V version add DM to the end of the code</i>	RTB-----DM
DALI	DA	per ordinare la versione DALI aggiungere DA alla fine del codice <i>to order the DALI version add DA to the end of the code</i>	RTB-----DA

con controllo della luce wireless Bluetooth
wireless Bluetooth lighting control

versioni <i>version</i>	suffisso codice <i>code suffix</i>	nota <i>note</i>	esempio <i>example</i>
PAN Digital	PD	per ordinare la versione per smart application PAN Digital aggiungere PD alla fine del codice <i>to order the version for smart application PAN Digital add PD to the end of the code</i>	RTB-----PD
CASAMBI	CA	per ordinare la versione per smart application CASAMBI aggiungere CA alla fine del codice <i>to order the version for smart application CASAMBI add CA to the end of the code</i>	RTB-----CA

versioni Bluetooth per "smart application"; **vedi dettagli alle pagine 8 - 9**
Bluetooth versions for "smart application"; see details to pages 8 - 9

Kit Emergenza / Emergency Kit

autonomia <i>operation time</i>	tempo di accensione <i>switching time</i>	tempo di ricarica <i>recharging time</i>	foro di incasso minimo (*) <i>minimum recessing hole (*)</i>	IP <i>IP</i>	peso <i>weight</i>	codice <i>code</i>
1 ora / 1 hour	0,5 sec.	24 h.	Ø 75 mm.	IP20	0,43 kg	DRV9092
3 ora / 3 hour	0,5 sec.	24 h.	Ø 100mm.	IP20	0,88 kg	DRV9091

(*) per l'installazione in controsoffitto verificare la compatibilità con il foro di incasso; **vedi dettagli a pagina 546**
() for installation in false ceiling check the compatibility with the recessing hole; see details to page 546*



CCT CCT	potenza power	ottica optic	flusso effettivo lumen output	UGR UGR	satinata matt	speculare mirror	nero titanio titanium	oro lucido gold	bianco opaco matt white
2700 K	10 W	15°	888 lm	≤ 19	RTB20141	RTB20241	RTB20341	RTB20441	RTB20541
		24°	894 lm	≤ 19	RTB20142	RTB20242	RTB20342	RTB20442	RTB20542
		38°	896 lm	≤ 19	RTB20143	RTB20243	RTB20343	RTB20443	RTB20543
		55°	899 lm	≤ 19	RTB20144	RTB20244	RTB20344	RTB20444	RTB20544
	15 W	15°	1359 lm	≤ 17	RTB20145	RTB20245	RTB20345	RTB20445	RTB20545
		24°	1363 lm	≤ 17	RTB20146	RTB20246	RTB20346	RTB20446	RTB20546
		38°	1371 lm	≤ 19	RTB20147	RTB20247	RTB20347	RTB20447	RTB20547
		55°	1383 lm	≤ 19	RTB20148	RTB20248	RTB20348	RTB20448	RTB20548
	24 W	15°	2056 lm	≤ 17	RTB20149	RTB20249	RTB20349	RTB20449	RTB20549
		24°	2058 lm	≤ 17	RTB20150	RTB20250	RTB20350	RTB20450	RTB20550
		38°	2064 lm	≤ 19	RTB20151	RTB20251	RTB20351	RTB20451	RTB20551
		55°	2070 lm	≤ 21	RTB20152	RTB20252	RTB20352	RTB20452	RTB20552
	33 W	15°	2938 lm	≤ 17	RTB20153	RTB20253	RTB20353	RTB20453	RTB20553
		24°	2946 lm	≤ 17	RTB20154	RTB20254	RTB20354	RTB20454	RTB20554
		38°	2954 lm	≤ 19	RTB20155	RTB20255	RTB20355	RTB20455	RTB20555
		55°	2960 lm	≤ 21	RTB20156	RTB20256	RTB20356	RTB20456	RTB20556
	42 W	15°	3678 lm	≤ 17	RTB20157	RTB20257	RTB20357	RTB20457	RTB20557
		24°	3684 lm	≤ 17	RTB20158	RTB20258	RTB20358	RTB20458	RTB20558
		38°	3690 lm	≤ 19	RTB20159	RTB20259	RTB20359	RTB20459	RTB20559
		55°	3696 lm	≤ 21	RTB20160	RTB20260	RTB20360	RTB20460	RTB20560
3000 K	10 W	15°	918 lm	≤ 19	RTB20101	RTB20201	RTB20301	RTB20401	RTB20501
		24°	924 lm	≤ 19	RTB20103	RTB20203	RTB20303	RTB20403	RTB20503
		38°	926 lm	≤ 19	RTB20105	RTB20205	RTB20305	RTB20405	RTB20505
		55°	930 lm	≤ 19	RTB20107	RTB20207	RTB20307	RTB20407	RTB20507
	15 W	15°	1408 lm	≤ 17	RTB20109	RTB20209	RTB20309	RTB20409	RTB20509
		24°	1412 lm	≤ 17	RTB20111	RTB20211	RTB20311	RTB20411	RTB20511
		38°	1420 lm	≤ 19	RTB20113	RTB20213	RTB20313	RTB20413	RTB20513
		55°	1432 lm	≤ 19	RTB20115	RTB20215	RTB20315	RTB20415	RTB20515
	24 W	15°	2150 lm	≤ 17	RTB20117	RTB20217	RTB20317	RTB20417	RTB20517
		24°	2152 lm	≤ 17	RTB20119	RTB20219	RTB20319	RTB20419	RTB20519
		38°	2158 lm	≤ 19	RTB20121	RTB20221	RTB20321	RTB20421	RTB20521
		55°	2164 lm	≤ 21	RTB20123	RTB20223	RTB20323	RTB20423	RTB20523
	33 W	15°	3032 lm	≤ 17	RTB20125	RTB20225	RTB20325	RTB20425	RTB20525
		24°	3040 lm	≤ 17	RTB20127	RTB20227	RTB20327	RTB20427	RTB20527
		38°	3048 lm	≤ 19	RTB20129	RTB20229	RTB20329	RTB20429	RTB20529
		55°	3054 lm	≤ 21	RTB20131	RTB20231	RTB20331	RTB20431	RTB20531
	42 W	15°	3780 lm	≤ 17	RTB20133	RTB20233	RTB20333	RTB20433	RTB20533
		24°	3786 lm	≤ 17	RTB20135	RTB20235	RTB20335	RTB20435	RTB20535
		38°	3792 lm	≤ 19	RTB20137	RTB20237	RTB20337	RTB20437	RTB20537
		55°	3798 lm	≤ 21	RTB20139	RTB20239	RTB20339	RTB20439	RTB20539
4000 K	10 W	15°	956 lm	≤ 19	RTB20102	RTB20202	RTB20302	RTB20402	RTB20502
		24°	958 lm	≤ 19	RTB20104	RTB20204	RTB20304	RTB20404	RTB20504
		38°	968 lm	≤ 19	RTB20106	RTB20206	RTB20306	RTB20406	RTB20506
		55°	974 lm	≤ 19	RTB20108	RTB20208	RTB20308	RTB20408	RTB20508
	15 W	15°	1486 lm	≤ 17	RTB20110	RTB20210	RTB20310	RTB20410	RTB20510
		24°	1494 lm	≤ 17	RTB20112	RTB20212	RTB20312	RTB20412	RTB20512
		38°	1500 lm	≤ 19	RTB20114	RTB20214	RTB20314	RTB20414	RTB20514
		55°	1502 lm	≤ 19	RTB20116	RTB20216	RTB20316	RTB20416	RTB20516
	24 W	15°	2210 lm	≤ 17	RTB20118	RTB20218	RTB20318	RTB20418	RTB20518
		24°	2218 lm	≤ 17	RTB20120	RTB20220	RTB20320	RTB20420	RTB20520
		38°	2226 lm	≤ 19	RTB20122	RTB20222	RTB20322	RTB20422	RTB20522
		55°	2234 lm	≤ 21	RTB20124	RTB20224	RTB20324	RTB20424	RTB20524
	33 W	15°	3116 lm	≤ 17	RTB20126	RTB20226	RTB20326	RTB20426	RTB20526
		24°	3120 lm	≤ 17	RTB20128	RTB20228	RTB20328	RTB20428	RTB20528
		38°	3128 lm	≤ 19	RTB20130	RTB20230	RTB20330	RTB20430	RTB20530
		55°	3134 lm	≤ 21	RTB20132	RTB20232	RTB20332	RTB20432	RTB20532
	42 W	15°	3842 lm	≤ 17	RTB20134	RTB20234	RTB20334	RTB20434	RTB20534
		24°	3858 lm	≤ 17	RTB20136	RTB20236	RTB20336	RTB20436	RTB20536
		38°	3864 lm	≤ 19	RTB20138	RTB20238	RTB20338	RTB20438	RTB20538
		55°	3878 lm	≤ 21	RTB20140	RTB20240	RTB20340	RTB20440	RTB20540

Nemo Adj

anello bianco / *white ring*



Ottiche / *Optics*

vedi pg. 210 / *see pg. 210*

Ricambi / *Spare parts*

vedi pg. 284 / *see pg. 284*

Versioni dimmerabili / *Dimmable versions*

con regolazione via cavo
wired dimmable

versioni <i>version</i>	suffisso codice <i>code suffix</i>	nota <i>note</i>	esempio <i>example</i>
Push 1...10 V	DM	per ordinare la versione PUSH / 1...10 V aggiungere DM alla fine del codice <i>to order the PUSH / 1...10 V version add DM to the end of the code</i>	RTL-----DM
DALI	DA	per ordinare la versione DALI aggiungere DA alla fine del codice <i>to order the DALI version add DA to the end of the code</i>	RTL-----DA

con controllo della luce wireless Bluetooth
wireless Bluetooth lighting control

versioni <i>version</i>	suffisso codice <i>code suffix</i>	nota <i>note</i>	esempio <i>example</i>
PAN Digital	PD	per ordinare la versione per smart application PAN Digital aggiungere PD alla fine del codice <i>to order the version for smart application PAN Digital add PD to the end of the code</i>	RTL-----PD
CASAMBI	CA	per ordinare la versione per smart application CASAMBI aggiungere CA alla fine del codice <i>to order the version for smart application CASAMBI add CA to the end of the code</i>	RTL-----CA

versioni Bluetooth per "smart application"; **vedi dettagli alle pagine 8 - 9**
Bluetooth versions for "smart application"; see details to pages 8 - 9

Kit Emergenza / *Emergency Kit*

autonomia <i>operation time</i>	tempo di accensione <i>switching time</i>	tempo di ricarica <i>recharging time</i>	foro di incasso minimo (*) <i>minimum recessing hole (*)</i>	IP <i>IP</i>	peso <i>weight</i>	codice <i>code</i>
1 ora / 1 hour	0,5 sec.	24 h.	Ø 75 mm.	IP20	0,43 kg	DRV9092
3 ora / 3 hour	0,5 sec.	24 h.	Ø 100mm.	IP20	0,88 kg	DRV9091

(*) per l'installazione in controsoffitto verificare la compatibilità con il foro di incasso; **vedi dettagli a pagina 546**
() for installation in false ceiling check the compatibility with the recessing hole; see details to page 546*

Nemo Adj

anello bianco / white ring



CCT CCT	potenza power	ottica optic	flusso effettivo lumen output	UGR UGR	satinata matt	speculare mirror	nero titanio titanium	oro lucido gold	bianco opaco matt white	
2700 K	10 W	15°	888 lm	≤ 19	RTL25141	RTL25241	RTL25341	RTL25441	RTL25541	
		24°	894 lm	≤ 19	RTL25142	RTL25242	RTL25342	RTL25442	RTL25542	
		38°	896 lm	≤ 19	RTL25143	RTL25243	RTL25343	RTL25443	RTL25543	
		55°	899 lm	≤ 19	RTL25144	RTL25244	RTL25344	RTL25444	RTL25544	
	15 W	15°	1359 lm	≤ 17	RTL25145	RTL25245	RTL25345	RTL25445	RTL25545	
		24°	1363 lm	≤ 17	RTL25146	RTL25246	RTL25346	RTL25446	RTL25546	
		38°	1371 lm	≤ 19	RTL25147	RTL25247	RTL25347	RTL25447	RTL25547	
		55°	1383 lm	≤ 19	RTL25148	RTL25248	RTL25348	RTL25448	RTL25548	
	24 W	15°	2056 lm	≤ 17	RTL25149	RTL25249	RTL25349	RTL25449	RTL25549	
		24°	2058 lm	≤ 17	RTL25150	RTL25250	RTL25350	RTL25450	RTL25550	
		38°	2064 lm	≤ 19	RTL25151	RTL25251	RTL25351	RTL25451	RTL25551	
		55°	2070 lm	≤ 21	RTL25152	RTL25252	RTL25352	RTL25452	RTL25552	
	33 W	15°	2938 lm	≤ 17	RTL25153	RTL25253	RTL25353	RTL25453	RTL25553	
		24°	2946 lm	≤ 17	RTL25154	RTL25254	RTL25354	RTL25454	RTL25554	
		38°	2954 lm	≤ 19	RTL25155	RTL25255	RTL25355	RTL25455	RTL25555	
		55°	2960 lm	≤ 21	RTL25156	RTL25256	RTL25356	RTL25456	RTL25556	
	3000 K	10 W	15°	918 lm	≤ 19	RTL25101	RTL25201	RTL25301	RTL25401	RTL25501
			24°	924 lm	≤ 19	RTL25103	RTL25203	RTL25303	RTL25403	RTL25503
			38°	926 lm	≤ 19	RTL25105	RTL25205	RTL25305	RTL25405	RTL25505
			55°	930 lm	≤ 19	RTL25107	RTL25207	RTL25307	RTL25407	RTL25507
15 W		15°	1408 lm	≤ 17	RTL25109	RTL25209	RTL25309	RTL25409	RTL25509	
		24°	1412 lm	≤ 17	RTL25111	RTL25211	RTL25311	RTL25411	RTL25511	
		38°	1420 lm	≤ 19	RTL25113	RTL25213	RTL25313	RTL25413	RTL25513	
		55°	1432 lm	≤ 19	RTL25115	RTL25215	RTL25315	RTL25415	RTL25515	
24 W		15°	2150 lm	≤ 17	RTL25117	RTL25217	RTL25317	RTL25417	RTL25517	
		24°	2152 lm	≤ 17	RTL25119	RTL25219	RTL25319	RTL25419	RTL25519	
		38°	2158 lm	≤ 19	RTL25121	RTL25221	RTL25321	RTL25421	RTL25521	
		55°	2164 lm	≤ 21	RTL25123	RTL25223	RTL25323	RTL25423	RTL25523	
33 W		15°	3032 lm	≤ 17	RTL25125	RTL25225	RTL25325	RTL25425	RTL25525	
		24°	3040 lm	≤ 17	RTL25127	RTL25227	RTL25327	RTL25427	RTL25527	
		38°	3048 lm	≤ 19	RTL25129	RTL25229	RTL25329	RTL25429	RTL25529	
		55°	3054 lm	≤ 21	RTL25131	RTL25231	RTL25331	RTL25431	RTL25531	
4000 K		10 W	15°	956 lm	≤ 19	RTL25102	RTL25202	RTL25302	RTL25402	RTL25502
			24°	958 lm	≤ 19	RTL25104	RTL25204	RTL25304	RTL25404	RTL25504
			38°	968 lm	≤ 19	RTL25106	RTL25206	RTL25306	RTL25406	RTL25506
			55°	974 lm	≤ 19	RTL25108	RTL25208	RTL25308	RTL25408	RTL25508
	15 W	15°	1486 lm	≤ 17	RTL25110	RTL25210	RTL25310	RTL25410	RTL25510	
		24°	1494 lm	≤ 17	RTL25112	RTL25212	RTL25312	RTL25412	RTL25512	
		38°	1500 lm	≤ 19	RTL25114	RTL25214	RTL25314	RTL25414	RTL25514	
		55°	1502 lm	≤ 19	RTL25116	RTL25216	RTL25316	RTL25416	RTL25516	
	24 W	15°	2210 lm	≤ 17	RTL25118	RTL25218	RTL25318	RTL25418	RTL25518	
		24°	2218 lm	≤ 17	RTL25120	RTL25220	RTL25320	RTL25420	RTL25520	
		38°	2226 lm	≤ 19	RTL25122	RTL25222	RTL25322	RTL25422	RTL25522	
		55°	2234 lm	≤ 21	RTL25124	RTL25224	RTL25324	RTL25424	RTL25524	
	33 W	15°	3116 lm	≤ 17	RTL25126	RTL25226	RTL25326	RTL25426	RTL25526	
		24°	3120 lm	≤ 17	RTL25128	RTL25228	RTL25328	RTL25428	RTL25528	
		38°	3128 lm	≤ 19	RTL25130	RTL25230	RTL25330	RTL25430	RTL25530	
		55°	3134 lm	≤ 21	RTL25132	RTL25232	RTL25332	RTL25432	RTL25532	

Nemo Adj

anello nero / *black ring*



Ottiche / Optics

vedi pg. 210 / *see pg. 210*

Ricambi / Spare parts

vedi pg. 284 / *see pg. 284*

Versioni dimmerabili / Dimmable versions

con regolazione via cavo
wired dimmable

versioni <i>version</i>	suffisso codice <i>code suffix</i>	nota <i>note</i>	esempio <i>example</i>
Push 1...10 V	DM	per ordinare la versione PUSH / 1...10 V aggiungere DM alla fine del codice <i>to order the PUSH / 1...10 V version add DM to the end of the code</i>	RTB-----DM
DALI	DA	per ordinare la versione DALI aggiungere DA alla fine del codice <i>to order the DALI version add DA to the end of the code</i>	RTB-----DA

con controllo della luce wireless Bluetooth
wireless Bluetooth lighting control

versioni <i>version</i>	suffisso codice <i>code suffix</i>	nota <i>note</i>	esempio <i>example</i>
PAN Digital	PD	per ordinare la versione per smart application PAN Digital aggiungere PD alla fine del codice <i>to order the version for smart application PAN Digital add PD to the end of the code</i>	RTB-----PD
CASAMBI	CA	per ordinare la versione per smart application CASAMBI aggiungere CA alla fine del codice <i>to order the version for smart application CASAMBI add CA to the end of the code</i>	RTB-----CA

versioni Bluetooth per "smart application"; **vedi dettagli alle pagine 8 - 9**
Bluetooth versions for "smart application"; see details to pages 8 - 9

Kit Emergenza / Emergency Kit

autonomia <i>operation time</i>	tempo di accensione <i>switching time</i>	tempo di ricarica <i>recharging time</i>	foro di incasso minimo (*) <i>minimum recessing hole (*)</i>	IP <i>IP</i>	peso <i>weight</i>	codice <i>code</i>
1 ora / 1 hour	0,5 sec.	24 h.	Ø 75 mm.	IP20	0,43 kg	DRV9092
3 ora / 3 hour	0,5 sec.	24 h.	Ø 100mm.	IP20	0,88 kg	DRV9091

(*) per l'installazione in controsoffitto verificare la compatibilità con il foro di incasso; **vedi dettagli a pagina 546**
() for installation in false ceiling check the compatibility with the recessing hole; see details to page 546*

Nemo Adj anello nero / black ring



CCT CCT	potenza power	ottica optic	flusso effettivo lumen output	UGR UGR	satinata matt	speculare mirror	nero titanio titanium	oro lucido gold	bianco opaco matt white	
2700 K	10 W	15°	888 lm	≤ 19	RTB25141	RTB25241	RTB25341	RTB25441	RTB25541	
		24°	894 lm	≤ 19	RTB25142	RTB25242	RTB25342	RTB25442	RTB25542	
		38°	896 lm	≤ 19	RTB25143	RTB25243	RTB25343	RTB25443	RTB25543	
		55°	899 lm	≤ 19	RTB25144	RTB25244	RTB25344	RTB25444	RTB25544	
	15 W	15°	1359 lm	≤ 17	RTB25145	RTB25245	RTB25345	RTB25445	RTB25545	
		24°	1363 lm	≤ 17	RTB25146	RTB25246	RTB25346	RTB25446	RTB25546	
		38°	1371 lm	≤ 19	RTB25147	RTB25247	RTB25347	RTB25447	RTB25547	
		55°	1383 lm	≤ 19	RTB25148	RTB25248	RTB25348	RTB25448	RTB25548	
	24 W	15°	2056 lm	≤ 17	RTB25149	RTB25249	RTB25349	RTB25449	RTB25549	
		24°	2058 lm	≤ 17	RTB25150	RTB25250	RTB25350	RTB25450	RTB25550	
		38°	2064 lm	≤ 19	RTB25151	RTB25251	RTB25351	RTB25451	RTB25551	
		55°	2070 lm	≤ 21	RTB25152	RTB25252	RTB25352	RTB25452	RTB25552	
	33 W	15°	2938 lm	≤ 17	RTB25153	RTB25253	RTB25353	RTB25453	RTB25553	
		24°	2946 lm	≤ 17	RTB25154	RTB25254	RTB25354	RTB25454	RTB25554	
		38°	2954 lm	≤ 19	RTB25155	RTB25255	RTB25355	RTB25455	RTB25555	
		55°	2960 lm	≤ 21	RTB25156	RTB25256	RTB25356	RTB25456	RTB25556	
	3000 K	10 W	15°	918 lm	≤ 19	RTB25101	RTB25201	RTB25301	RTB25401	RTB25501
			24°	924 lm	≤ 19	RTB25103	RTB25203	RTB25303	RTB25403	RTB25503
			38°	926 lm	≤ 19	RTB25105	RTB25205	RTB25305	RTB25405	RTB25505
			55°	930 lm	≤ 19	RTB25107	RTB25207	RTB25307	RTB25407	RTB25507
15 W		15°	1408 lm	≤ 17	RTB25109	RTB25209	RTB25309	RTB25409	RTB25509	
		24°	1412 lm	≤ 17	RTB25111	RTB25211	RTB25311	RTB25411	RTB25511	
		38°	1420 lm	≤ 19	RTB25113	RTB25213	RTB25313	RTB25413	RTB25513	
		55°	1432 lm	≤ 19	RTB25115	RTB25215	RTB25315	RTB25415	RTB25515	
24 W		15°	2150 lm	≤ 17	RTB25117	RTB25217	RTB25317	RTB25417	RTB25517	
		24°	2152 lm	≤ 17	RTB25119	RTB25219	RTB25319	RTB25419	RTB25519	
		38°	2158 lm	≤ 19	RTB25121	RTB25221	RTB25321	RTB25421	RTB25521	
		55°	2164 lm	≤ 21	RTB25123	RTB25223	RTB25323	RTB25423	RTB25523	
33 W		15°	3032 lm	≤ 17	RTB25125	RTB25225	RTB25325	RTB25425	RTB25525	
		24°	3040 lm	≤ 17	RTB25127	RTB25227	RTB25327	RTB25427	RTB25527	
		38°	3048 lm	≤ 19	RTB25129	RTB25229	RTB25329	RTB25429	RTB25529	
		55°	3054 lm	≤ 21	RTB25131	RTB25231	RTB25331	RTB25431	RTB25531	
4000 K		10 W	15°	956 lm	≤ 19	RTB25102	RTB25202	RTB25302	RTB25402	RTB25502
			24°	958 lm	≤ 19	RTB25104	RTB25204	RTB25304	RTB25404	RTB25504
			38°	968 lm	≤ 19	RTB25106	RTB25206	RTB25306	RTB25406	RTB25506
			55°	974 lm	≤ 19	RTB25108	RTB25208	RTB25308	RTB25408	RTB25508
	15 W	15°	1486 lm	≤ 17	RTB25110	RTB25210	RTB25310	RTB25410	RTB25510	
		24°	1494 lm	≤ 17	RTB25112	RTB25212	RTB25312	RTB25412	RTB25512	
		38°	1500 lm	≤ 19	RTB25114	RTB25214	RTB25314	RTB25414	RTB25514	
		55°	1502 lm	≤ 19	RTB25116	RTB25216	RTB25316	RTB25416	RTB25516	
	24 W	15°	2210 lm	≤ 17	RTB25118	RTB25218	RTB25318	RTB25418	RTB25518	
		24°	2218 lm	≤ 17	RTB25120	RTB25220	RTB25320	RTB25420	RTB25520	
		38°	2226 lm	≤ 19	RTB25122	RTB25222	RTB25322	RTB25422	RTB25522	
		55°	2234 lm	≤ 21	RTB25124	RTB25224	RTB25324	RTB25424	RTB25524	
	33 W	15°	3116 lm	≤ 17	RTB25126	RTB25226	RTB25326	RTB25426	RTB25526	
		24°	3120 lm	≤ 17	RTB25128	RTB25228	RTB25328	RTB25428	RTB25528	
		38°	3128 lm	≤ 19	RTB25130	RTB25230	RTB25330	RTB25430	RTB25530	
		55°	3134 lm	≤ 21	RTB25132	RTB25232	RTB25332	RTB25432	RTB25532	





Nemo Fix

anello bianco / *white ring*



Ottiche / Optics

vedi pg. 210 / *see pg. 210*

Ricambi / Spare parts

vedi pg. 284 / *see pg. 284*

Versioni dimmerabili / Dimmable versions

con regolazione via cavo
wired dimmable

versioni <i>version</i>	suffisso codice <i>code suffix</i>	nota <i>note</i>	esempio <i>example</i>
Push 1...10 V	DM	per ordinare la versione PUSH / 1...10 V aggiungere DM alla fine del codice <i>to order the PUSH / 1...10 V version add DM to the end of the code</i>	RTL-----DM
DALI	DA	per ordinare la versione DALI aggiungere DA alla fine del codice <i>to order the DALI version add DA to the end of the code</i>	RTL-----DA

con controllo della luce wireless Bluetooth
wireless Bluetooth lighting control

versioni <i>version</i>	suffisso codice <i>code suffix</i>	nota <i>note</i>	esempio <i>example</i>
PAN Digital	PD	per ordinare la versione per smart application PAN Digital aggiungere PD alla fine del codice <i>to order the version for smart application PAN Digital add PD to the end of the code</i>	RTL-----PD
CASAMBI	CA	per ordinare la versione per smart application CASAMBI aggiungere CA alla fine del codice <i>to order the version for smart application CASAMBI add CA to the end of the code</i>	RTL-----CA

versioni Bluetooth per "smart application"; **vedi dettagli alle pagine 8 - 9**
Bluetooth versions for "smart application"; see details to pages 8 - 9

Kit Emergenza / Emergency Kit

autonomia <i>operation time</i>	tempo di accensione <i>switching time</i>	tempo di ricarica <i>recharging time</i>	foro di incasso minimo (*) <i>minimum recessing hole (*)</i>	IP <i>IP</i>	peso <i>weight</i>	codice <i>code</i>
1 ora / 1 hour	0,5 sec.	24 h.	Ø 75 mm.	IP20	0,43 kg	DRV9092
3 ora / 3 hour	0,5 sec.	24 h.	Ø 100mm.	IP20	0,88 kg	DRV9091

(*) per l'installazione in controsoffitto verificare la compatibilità con il foro di incasso; **vedi dettagli a pagina 546**
() for installation in false ceiling check the compatibility with the recessing hole; see details to page 546*

Nemo Fix anello bianco / white ring



CCT CCT	potenza power	ottica optic	flusso effettivo lumen output	UGR UGR	satinata matt	speculare mirror	nero titanio titanium	oro lucido gold	bianco opaco matt white
2700 K	10 W	15°	888 lm	≤ 19	RTL21141	RTL21241	RTL21341	RTL21441	RTL21541
		24°	894 lm	≤ 19	RTL21142	RTL21242	RTL21342	RTL21442	RTL21542
		38°	896 lm	≤ 19	RTL21143	RTL21243	RTL21343	RTL21443	RTL21543
		55°	899 lm	≤ 19	RTL21144	RTL21244	RTL21344	RTL21444	RTL21544
	15 W	15°	1359 lm	≤ 17	RTL21145	RTL21245	RTL21345	RTL21445	RTL21545
		24°	1363 lm	≤ 17	RTL21146	RTL21246	RTL21346	RTL21446	RTL21546
		38°	1371 lm	≤ 19	RTL21147	RTL21247	RTL21347	RTL21447	RTL21547
		55°	1383 lm	≤ 19	RTL21148	RTL21248	RTL21348	RTL21448	RTL21548
	24 W	15°	2056 lm	≤ 17	RTL21149	RTL21249	RTL21349	RTL21449	RTL21549
		24°	2058 lm	≤ 17	RTL21150	RTL21250	RTL21350	RTL21450	RTL21550
		38°	2064 lm	≤ 19	RTL21151	RTL21251	RTL21351	RTL21451	RTL21551
		55°	2070 lm	≤ 21	RTL21152	RTL21252	RTL21352	RTL21452	RTL21552
	33 W	15°	2938 lm	≤ 17	RTL21153	RTL21253	RTL21353	RTL21453	RTL21553
		24°	2946 lm	≤ 17	RTL21154	RTL21254	RTL21354	RTL21454	RTL21554
		38°	2954 lm	≤ 19	RTL21155	RTL21255	RTL21355	RTL21455	RTL21555
		55°	2960 lm	≤ 21	RTL21156	RTL21256	RTL21356	RTL21456	RTL21556
	42 W	15°	3678 lm	≤ 17	RTL21157	RTL21257	RTL21357	RTL21457	RTL21557
		24°	3684 lm	≤ 17	RTL21158	RTL21258	RTL21358	RTL21458	RTL21558
		38°	3690 lm	≤ 19	RTL21159	RTL21259	RTL21359	RTL21459	RTL21559
		55°	3696 lm	≤ 21	RTL21160	RTL21260	RTL21360	RTL21460	RTL21560
3000 K	10 W	15°	918 lm	≤ 19	RTL21101	RTL21201	RTL21301	RTL21401	RTL21501
		24°	924 lm	≤ 19	RTL21103	RTL21203	RTL21303	RTL21403	RTL21503
		38°	926 lm	≤ 19	RTL21105	RTL21205	RTL21305	RTL21405	RTL21505
		55°	930 lm	≤ 19	RTL21107	RTL21207	RTL21307	RTL21407	RTL21507
	15 W	15°	1408 lm	≤ 17	RTL21109	RTL21209	RTL21309	RTL21409	RTL21509
		24°	1412 lm	≤ 17	RTL21111	RTL21211	RTL21311	RTL21411	RTL21511
		38°	1420 lm	≤ 19	RTL21113	RTL21213	RTL21313	RTL21413	RTL21513
		55°	1432 lm	≤ 19	RTL21115	RTL21215	RTL21315	RTL21415	RTL21515
	24 W	15°	2150 lm	≤ 17	RTL21117	RTL21217	RTL21317	RTL21417	RTL21517
		24°	2152 lm	≤ 17	RTL21119	RTL21219	RTL21319	RTL21419	RTL21519
		38°	2158 lm	≤ 19	RTL21121	RTL21221	RTL21321	RTL21421	RTL21521
		55°	2164 lm	≤ 21	RTL21123	RTL21223	RTL21323	RTL21423	RTL21523
	33 W	15°	3032 lm	≤ 17	RTL21125	RTL21225	RTL21325	RTL21425	RTL21525
		24°	3040 lm	≤ 17	RTL21127	RTL21227	RTL21327	RTL21427	RTL21527
		38°	3048 lm	≤ 19	RTL21129	RTL21229	RTL21329	RTL21429	RTL21529
		55°	3054 lm	≤ 21	RTL21131	RTL21231	RTL21331	RTL21431	RTL21531
	42 W	15°	3780 lm	≤ 17	RTL21133	RTL21233	RTL21333	RTL21433	RTL21533
		24°	3786 lm	≤ 17	RTL21135	RTL21235	RTL21335	RTL21435	RTL21535
		38°	3792 lm	≤ 19	RTL21137	RTL21237	RTL21337	RTL21437	RTL21537
		55°	3798 lm	≤ 21	RTL21139	RTL21239	RTL21339	RTL21439	RTL21539
4000 K	10 W	15°	956 lm	≤ 19	RTL21102	RTL21202	RTL21302	RTL21402	RTL21502
		24°	958 lm	≤ 19	RTL21104	RTL21204	RTL21304	RTL21404	RTL21504
		38°	968 lm	≤ 19	RTL21106	RTL21206	RTL21306	RTL21406	RTL21506
		55°	974 lm	≤ 19	RTL21108	RTL21208	RTL21308	RTL21408	RTL21508
	15 W	15°	1486 lm	≤ 17	RTL21110	RTL21210	RTL21310	RTL21410	RTL21510
		24°	1494 lm	≤ 17	RTL21112	RTL21212	RTL21312	RTL21412	RTL21512
		38°	1500 lm	≤ 19	RTL21114	RTL21214	RTL21314	RTL21414	RTL21514
		55°	1502 lm	≤ 19	RTL21116	RTL21216	RTL21316	RTL21416	RTL21516
	24 W	15°	2210 lm	≤ 17	RTL21118	RTL21218	RTL21318	RTL21418	RTL21518
		24°	2218 lm	≤ 17	RTL21120	RTL21220	RTL21320	RTL21420	RTL21520
		38°	2226 lm	≤ 19	RTL21122	RTL21222	RTL21322	RTL21422	RTL21522
		55°	2234 lm	≤ 21	RTL21124	RTL21224	RTL21324	RTL21424	RTL21524
	33 W	15°	3116 lm	≤ 17	RTL21126	RTL21226	RTL21326	RTL21426	RTL21526
		24°	3120 lm	≤ 17	RTL21128	RTL21228	RTL21328	RTL21428	RTL21528
		38°	3128 lm	≤ 19	RTL21130	RTL21230	RTL21330	RTL21430	RTL21530
		55°	3134 lm	≤ 21	RTL21132	RTL21232	RTL21332	RTL21432	RTL21532
	42 W	15°	3842 lm	≤ 17	RTL21134	RTL21234	RTL21334	RTL21434	RTL21534
		24°	3858 lm	≤ 17	RTL21136	RTL21236	RTL21336	RTL21436	RTL21536
		38°	3864 lm	≤ 19	RTL21138	RTL21238	RTL21338	RTL21438	RTL21538
		55°	3878 lm	≤ 21	RTL21140	RTL21240	RTL21340	RTL21440	RTL21540

Nemo Fix

anello nero / *black ring*



Ottiche / Optics

vedi pg. 210 / *see pg. 210*

Ricambi / Spare parts

vedi pg. 284 / *see pg. 284*

Versioni dimmerabili / Dimmable versions

con regolazione via cavo
wired dimmable

versioni <i>version</i>	suffisso codice <i>code suffix</i>	nota <i>note</i>	esempio <i>example</i>
Push 1...10 V	DM	per ordinare la versione PUSH / 1...10 V aggiungere DM alla fine del codice <i>to order the PUSH / 1...10 V version add DM to the end of the code</i>	RTB-----DM
DALI	DA	per ordinare la versione DALI aggiungere DA alla fine del codice <i>to order the DALI version add DA to the end of the code</i>	RTB-----DA

con controllo della luce wireless Bluetooth
wireless Bluetooth lighting control

versioni <i>version</i>	suffisso codice <i>code suffix</i>	nota <i>note</i>	esempio <i>example</i>
PAN Digital	PD	per ordinare la versione per smart application PAN Digital aggiungere PD alla fine del codice <i>to order the version for smart application PAN Digital add PD to the end of the code</i>	RTB-----PD
CASAMBI	CA	per ordinare la versione per smart application CASAMBI aggiungere CA alla fine del codice <i>to order the version for smart application CASAMBI add CA to the end of the code</i>	RTB-----CA

versioni Bluetooth per "smart application"; **vedi dettagli alle pagine 8 - 9**
Bluetooth versions for "smart application"; see details to pages 8 - 9

Kit Emergenza / Emergency Kit

autonomia <i>operation time</i>	tempo di accensione <i>switching time</i>	tempo di ricarica <i>recharging time</i>	foro di incasso minimo (*) <i>minimum recessing hole (*)</i>	IP <i>IP</i>	peso <i>weight</i>	codice <i>code</i>
1 ora / 1 hour	0,5 sec.	24 h.	Ø 75 mm.	IP20	0,43 kg	DRV9092
3 ora / 3 hour	0,5 sec.	24 h.	Ø 100mm.	IP20	0,88 kg	DRV9091

(*) per l'installazione in controsoffitto verificare la compatibilità con il foro di incasso; **vedi dettagli a pagina 546**
() for installation in false ceiling check the compatibility with the recessing hole; see details to page 546*

Nemo Fix anello nero / black ring



CCT CCT	potenza power	ottica optic	flusso effettivo lumen output	UGR UGR	satinata matt	speculare mirror	nero titanio titanium	oro lucido gold	bianco opaco matt white
2700 K	10 W	15°	888 lm	≤ 19	RTB21141	RTB21241	RTB21341	RTB21441	RTB21541
		24°	894 lm	≤ 19	RTB21142	RTB21242	RTB21342	RTB21442	RTB21542
		38°	896 lm	≤ 19	RTB21143	RTB21243	RTB21343	RTB21443	RTB21543
		55°	899 lm	≤ 19	RTB21144	RTB21244	RTB21344	RTB21444	RTB21544
	15 W	15°	1359 lm	≤ 17	RTB21145	RTB21245	RTB21345	RTB21445	RTB21545
		24°	1363 lm	≤ 17	RTB21146	RTB21246	RTB21346	RTB21446	RTB21546
		38°	1371 lm	≤ 19	RTB21147	RTB21247	RTB21347	RTB21447	RTB21547
		55°	1383 lm	≤ 19	RTB21148	RTB21248	RTB21348	RTB21448	RTB21548
	24 W	15°	2056 lm	≤ 17	RTB21149	RTB21249	RTB21349	RTB21449	RTB21549
		24°	2058 lm	≤ 17	RTB21150	RTB21250	RTB21350	RTB21450	RTB21550
		38°	2064 lm	≤ 19	RTB21151	RTB21251	RTB21351	RTB21451	RTB21551
		55°	2070 lm	≤ 21	RTB21152	RTB21252	RTB21352	RTB21452	RTB21552
	33 W	15°	2938 lm	≤ 17	RTB21153	RTB21253	RTB21353	RTB21453	RTB21553
		24°	2946 lm	≤ 17	RTB21154	RTB21254	RTB21354	RTB21454	RTB21554
		38°	2954 lm	≤ 19	RTB21155	RTB21255	RTB21355	RTB21455	RTB21555
		55°	2960 lm	≤ 21	RTB21156	RTB21256	RTB21356	RTB21456	RTB21556
	42 W	15°	3678 lm	≤ 17	RTB21157	RTB21257	RTB21357	RTB21457	RTB21557
		24°	3684 lm	≤ 17	RTB21158	RTB21258	RTB21358	RTB21458	RTB21558
		38°	3690 lm	≤ 19	RTB21159	RTB21259	RTB21359	RTB21459	RTB21559
		55°	3696 lm	≤ 21	RTB21160	RTB21260	RTB21360	RTB21460	RTB21560
3000 K	10 W	15°	918 lm	≤ 19	RTB21101	RTB21201	RTB21301	RTB21401	RTB21501
		24°	924 lm	≤ 19	RTB21103	RTB21203	RTB21303	RTB21403	RTB21503
		38°	926 lm	≤ 19	RTB21105	RTB21205	RTB21305	RTB21405	RTB21505
		55°	930 lm	≤ 19	RTB21107	RTB21207	RTB21307	RTB21407	RTB21507
	15 W	15°	1408 lm	≤ 17	RTB21109	RTB21209	RTB21309	RTB21409	RTB21509
		24°	1412 lm	≤ 17	RTB21111	RTB21211	RTB21311	RTB21411	RTB21511
		38°	1420 lm	≤ 19	RTB21113	RTB21213	RTB21313	RTB21413	RTB21513
		55°	1432 lm	≤ 19	RTB21115	RTB21215	RTB21315	RTB21415	RTB21515
	24 W	15°	2150 lm	≤ 17	RTB21117	RTB21217	RTB21317	RTB21417	RTB21517
		24°	2152 lm	≤ 17	RTB21119	RTB21219	RTB21319	RTB21419	RTB21519
		38°	2158 lm	≤ 19	RTB21121	RTB21221	RTB21321	RTB21421	RTB21521
		55°	2164 lm	≤ 21	RTB21123	RTB21223	RTB21323	RTB21423	RTB21523
	33 W	15°	3032 lm	≤ 17	RTB21125	RTB21225	RTB21325	RTB21425	RTB21525
		24°	3040 lm	≤ 17	RTB21127	RTB21227	RTB21327	RTB21427	RTB21527
		38°	3048 lm	≤ 19	RTB21129	RTB21229	RTB21329	RTB21429	RTB21529
		55°	3054 lm	≤ 21	RTB21131	RTB21231	RTB21331	RTB21431	RTB21531
	42 W	15°	3780 lm	≤ 17	RTB21133	RTB21233	RTB21333	RTB21433	RTB21533
		24°	3786 lm	≤ 17	RTB21135	RTB21235	RTB21335	RTB21435	RTB21535
		38°	3792 lm	≤ 19	RTB21137	RTB21237	RTB21337	RTB21437	RTB21537
		55°	3798 lm	≤ 21	RTB21139	RTB21239	RTB21339	RTB21439	RTB21539
4000 K	10 W	15°	956 lm	≤ 19	RTB21102	RTB21202	RTB21302	RTB21402	RTB21502
		24°	958 lm	≤ 19	RTB21104	RTB21204	RTB21304	RTB21404	RTB21504
		38°	968 lm	≤ 19	RTB21106	RTB21206	RTB21306	RTB21406	RTB21506
		55°	974 lm	≤ 19	RTB21108	RTB21208	RTB21308	RTB21408	RTB21508
	15 W	15°	1486 lm	≤ 17	RTB21110	RTB21210	RTB21310	RTB21410	RTB21510
		24°	1494 lm	≤ 17	RTB21112	RTB21212	RTB21312	RTB21412	RTB21512
		38°	1500 lm	≤ 19	RTB21114	RTB21214	RTB21314	RTB21414	RTB21514
		55°	1502 lm	≤ 19	RTB21116	RTB21216	RTB21316	RTB21416	RTB21516
	24 W	15°	2210 lm	≤ 17	RTB21118	RTB21218	RTB21318	RTB21418	RTB21518
		24°	2218 lm	≤ 17	RTB21120	RTB21220	RTB21320	RTB21420	RTB21520
		38°	2226 lm	≤ 19	RTB21122	RTB21222	RTB21322	RTB21422	RTB21522
		55°	2234 lm	≤ 21	RTB21124	RTB21224	RTB21324	RTB21424	RTB21524
	33 W	15°	3116 lm	≤ 17	RTB21126	RTB21226	RTB21326	RTB21426	RTB21526
		24°	3120 lm	≤ 17	RTB21128	RTB21228	RTB21328	RTB21428	RTB21528
		38°	3128 lm	≤ 19	RTB21130	RTB21230	RTB21330	RTB21430	RTB21530
		55°	3134 lm	≤ 21	RTB21132	RTB21232	RTB21332	RTB21432	RTB21532
	42 W	15°	3842 lm	≤ 17	RTB21134	RTB21234	RTB21334	RTB21434	RTB21534
		24°	3858 lm	≤ 17	RTB21136	RTB21236	RTB21336	RTB21436	RTB21536
		38°	3864 lm	≤ 19	RTB21138	RTB21238	RTB21338	RTB21438	RTB21538
		55°	3878 lm	≤ 21	RTB21140	RTB21240	RTB21340	RTB21440	RTB21540

Nemo Fix

anello bianco / *white ring*



Ottiche / Optics

vedi pg. 210 / *see pg. 210*

Ricambi / Spare parts

vedi pg. 284 / *see pg. 284*

Versioni dimmerabili / Dimmable versions

con regolazione via cavo
wired dimmable

versioni <i>version</i>	suffisso codice <i>code suffix</i>	nota <i>note</i>	esempio <i>example</i>
Push 1...10 V	DM	per ordinare la versione PUSH / 1...10 V aggiungere DM alla fine del codice <i>to order the PUSH / 1...10 V version add DM to the end of the code</i>	RTL-----DM
DALI	DA	per ordinare la versione DALI aggiungere DA alla fine del codice <i>to order the DALI version add DA to the end of the code</i>	RTL-----DA

con controllo della luce wireless Bluetooth
wireless Bluetooth lighting control

versioni <i>version</i>	suffisso codice <i>code suffix</i>	nota <i>note</i>	esempio <i>example</i>
PAN Digital	PD	per ordinare la versione per smart application PAN Digital aggiungere PD alla fine del codice <i>to order the version for smart application PAN Digital add PD to the end of the code</i>	RTL-----PD
CASAMBI	CA	per ordinare la versione per smart application CASAMBI aggiungere CA alla fine del codice <i>to order the version for smart application CASAMBI add CA to the end of the code</i>	RTL-----CA

versioni Bluetooth per "smart application"; **vedi dettagli alle pagine 8 - 9**
Bluetooth versions for "smart application"; see details to pages 8 - 9

Kit Emergenza / Emergency Kit

autonomia <i>operation time</i>	tempo di accensione <i>switching time</i>	tempo di ricarica <i>recharging time</i>	foro di incasso minimo (*) <i>minimum recessing hole (*)</i>	IP <i>IP</i>	peso <i>weight</i>	codice <i>code</i>
1 ora / 1 hour	0,5 sec.	24 h.	Ø 75 mm.	IP20	0,43 kg	DRV9092
3 ora / 3 hour	0,5 sec.	24 h.	Ø 100mm.	IP20	0,88 kg	DRV9091

(*) per l'installazione in controsoffitto verificare la compatibilità con il foro di incasso; **vedi dettagli a pagina 546**
() for installation in false ceiling check the compatibility with the recessing hole; see details to page 546*

Nemo Fix anello bianco / white ring



CCT CCT	potenza power	ottica optic	flusso effettivo lumen output	UGR UGR	satinata matt	speculare mirror	nero titanio titanium	oro lucido gold	bianco opaco matt white	
2700 K	10 W	15°	888 lm	≤ 19	RTL26141	RTL26241	RTL26341	RTL26441	RTL26541	
		24°	894 lm	≤ 19	RTL26142	RTL26242	RTL26342	RTL26442	RTL26542	
		38°	896 lm	≤ 19	RTL26143	RTL26243	RTL26343	RTL26443	RTL26543	
		55°	899 lm	≤ 19	RTL26144	RTL26244	RTL26344	RTL26444	RTL26544	
	15 W	15°	1359 lm	≤ 17	RTL26145	RTL26245	RTL26345	RTL26445	RTL26545	
		24°	1363 lm	≤ 17	RTL26146	RTL26246	RTL26346	RTL26446	RTL26546	
		38°	1371 lm	≤ 19	RTL26147	RTL26247	RTL26347	RTL26447	RTL26547	
		55°	1383 lm	≤ 19	RTL26148	RTL26248	RTL26348	RTL26448	RTL26548	
	24 W	15°	2056 lm	≤ 17	RTL26149	RTL26249	RTL26349	RTL26449	RTL26549	
		24°	2058 lm	≤ 17	RTL26150	RTL26250	RTL26350	RTL26450	RTL26550	
		38°	2064 lm	≤ 19	RTL26151	RTL26251	RTL26351	RTL26451	RTL26551	
		55°	2070 lm	≤ 21	RTL26152	RTL26252	RTL26352	RTL26452	RTL26552	
	33 W	15°	2938 lm	≤ 17	RTL26153	RTL26253	RTL26353	RTL26453	RTL26553	
		24°	2946 lm	≤ 17	RTL26154	RTL26254	RTL26354	RTL26454	RTL26554	
		38°	2954 lm	≤ 19	RTL26155	RTL26255	RTL26355	RTL26455	RTL26555	
		55°	2960 lm	≤ 21	RTL26156	RTL26256	RTL26356	RTL26456	RTL26556	
	3000 K	10 W	15°	918 lm	≤ 19	RTL26101	RTL26201	RTL26301	RTL26401	RTL26501
			24°	924 lm	≤ 19	RTL26103	RTL26203	RTL26303	RTL26403	RTL26503
			38°	926 lm	≤ 19	RTL26105	RTL26205	RTL26305	RTL26405	RTL26505
			55°	930 lm	≤ 19	RTL26107	RTL26207	RTL26307	RTL26407	RTL26507
15 W		15°	1408 lm	≤ 17	RTL26109	RTL26209	RTL26309	RTL26409	RTL26509	
		24°	1412 lm	≤ 17	RTL26111	RTL26211	RTL26311	RTL26411	RTL26511	
		38°	1420 lm	≤ 19	RTL26113	RTL26213	RTL26313	RTL26413	RTL26513	
		55°	1432 lm	≤ 19	RTL26115	RTL26215	RTL26315	RTL26415	RTL26515	
24 W		15°	2150 lm	≤ 17	RTL26117	RTL26217	RTL26317	RTL26417	RTL26517	
		24°	2152 lm	≤ 17	RTL26119	RTL26219	RTL26319	RTL26419	RTL26519	
		38°	2158 lm	≤ 19	RTL26121	RTL26221	RTL26321	RTL26421	RTL26521	
		55°	2164 lm	≤ 21	RTL26123	RTL26223	RTL26323	RTL26423	RTL26523	
33 W		15°	3032 lm	≤ 17	RTL26125	RTL26225	RTL26325	RTL26425	RTL26525	
		24°	3040 lm	≤ 17	RTL26127	RTL26227	RTL26327	RTL26427	RTL26527	
		38°	3048 lm	≤ 19	RTL26129	RTL26229	RTL26329	RTL26429	RTL26529	
		55°	3054 lm	≤ 21	RTL26131	RTL26231	RTL26331	RTL26431	RTL26531	
4000 K		10 W	15°	956 lm	≤ 19	RTL26102	RTL26202	RTL26302	RTL26402	RTL26502
			24°	958 lm	≤ 19	RTL26104	RTL26204	RTL26304	RTL26404	RTL26504
			38°	968 lm	≤ 19	RTL26106	RTL26206	RTL26306	RTL26406	RTL26506
			55°	974 lm	≤ 19	RTL26108	RTL26208	RTL26308	RTL26408	RTL26508
	15 W	15°	1486 lm	≤ 17	RTL26110	RTL26210	RTL26310	RTL26410	RTL26510	
		24°	1494 lm	≤ 17	RTL26112	RTL26212	RTL26312	RTL26412	RTL26512	
		38°	1500 lm	≤ 19	RTL26114	RTL26214	RTL26314	RTL26414	RTL26514	
		55°	1502 lm	≤ 19	RTL26116	RTL26216	RTL26316	RTL26416	RTL26516	
	24 W	15°	2210 lm	≤ 17	RTL26118	RTL26218	RTL26318	RTL26418	RTL26518	
		24°	2218 lm	≤ 17	RTL26120	RTL26220	RTL26320	RTL26420	RTL26520	
		38°	2226 lm	≤ 19	RTL26122	RTL26222	RTL26322	RTL26422	RTL26522	
		55°	2234 lm	≤ 21	RTL26124	RTL26224	RTL26324	RTL26424	RTL26524	
	33 W	15°	3116 lm	≤ 17	RTL26126	RTL26226	RTL26326	RTL26426	RTL26526	
		24°	3120 lm	≤ 17	RTL26128	RTL26228	RTL26328	RTL26428	RTL26528	
		38°	3128 lm	≤ 19	RTL26130	RTL26230	RTL26330	RTL26430	RTL26530	
		55°	3134 lm	≤ 21	RTL26132	RTL26232	RTL26332	RTL26432	RTL26532	

Nemo Fix

anello nero / *black ring*



Ottiche / Optics

vedi pg. 210 / *see pg. 210*

Ricambi / Spare parts

vedi pg. 284 / *see pg. 284*

Versioni dimmerabili / Dimmable versions

con regolazione via cavo
wired dimmable

versioni <i>version</i>	suffisso codice <i>code suffix</i>	nota <i>note</i>	esempio <i>example</i>
Push 1...10 V	DM	per ordinare la versione PUSH / 1...10 V aggiungere DM alla fine del codice <i>to order the PUSH / 1...10 V version add DM to the end of the code</i>	RTB-----DM
DALI	DA	per ordinare la versione DALI aggiungere DA alla fine del codice <i>to order the DALI version add DA to the end of the code</i>	RTB-----DA

con controllo della luce wireless Bluetooth
wireless Bluetooth lighting control

versioni <i>version</i>	suffisso codice <i>code suffix</i>	nota <i>note</i>	esempio <i>example</i>
PAN Digital	PD	per ordinare la versione per smart application PAN Digital aggiungere PD alla fine del codice <i>to order the version for smart application PAN Digital add PD to the end of the code</i>	RTB-----PD
CASAMBI	CA	per ordinare la versione per smart application CASAMBI aggiungere CA alla fine del codice <i>to order the version for smart application CASAMBI add CA to the end of the code</i>	RTB-----CA

versioni Bluetooth per "smart application"; **vedi dettagli alle pagine 8 - 9**
Bluetooth versions for "smart application"; see details to pages 8 - 9

Kit Emergenza / Emergency Kit

autonomia <i>operation time</i>	tempo di accensione <i>switching time</i>	tempo di ricarica <i>recharging time</i>	foro di incasso minimo (*) <i>minimum recessing hole (*)</i>	IP <i>IP</i>	peso <i>weight</i>	codice <i>code</i>
1 ora / 1 hour	0,5 sec.	24 h.	Ø 75 mm.	IP20	0,43 kg	DRV9092
3 ora / 3 hour	0,5 sec.	24 h.	Ø 100mm.	IP20	0,88 kg	DRV9091

(*) per l'installazione in controsoffitto verificare la compatibilità con il foro di incasso; **vedi dettagli a pagina 546**
() for installation in false ceiling check the compatibility with the recessing hole; see details to page 546*

Nemo Fix anello nero / black ring



CCT CCT	potenza power	ottica optic	flusso effettivo lumen output	UGR UGR	satinata matt	speculare mirror	nero titanio titanium	oro lucido gold	bianco opaco matt white	
2700 K	10 W	15°	888 lm	≤ 19	RTB26141	RTB26241	RTB26341	RTB26441	RTB26541	
		24°	894 lm	≤ 19	RTB26142	RTB26242	RTB26342	RTB26442	RTB26542	
		38°	896 lm	≤ 19	RTB26143	RTB26243	RTB26343	RTB26443	RTB26543	
		55°	899 lm	≤ 19	RTB26144	RTB26244	RTB26344	RTB26444	RTB26544	
	15 W	15°	1359 lm	≤ 17	RTB26145	RTB26245	RTB26345	RTB26445	RTB26545	
		24°	1363 lm	≤ 17	RTB26146	RTB26246	RTB26346	RTB26446	RTB26546	
		38°	1371 lm	≤ 19	RTB26147	RTB26247	RTB26347	RTB26447	RTB26547	
		55°	1383 lm	≤ 19	RTB26148	RTB26248	RTB26348	RTB26448	RTB26548	
	24 W	15°	2056 lm	≤ 17	RTB26149	RTB26249	RTB26349	RTB26449	RTB26549	
		24°	2058 lm	≤ 17	RTB26150	RTB26250	RTB26350	RTB26450	RTB26550	
		38°	2064 lm	≤ 19	RTB26151	RTB26251	RTB26351	RTB26451	RTB26551	
		55°	2070 lm	≤ 21	RTB26152	RTB26252	RTB26352	RTB26452	RTB26552	
	33 W	15°	2938 lm	≤ 17	RTB26153	RTB26253	RTB26353	RTB26453	RTB26553	
		24°	2946 lm	≤ 17	RTB26154	RTB26254	RTB26354	RTB26454	RTB26554	
		38°	2954 lm	≤ 19	RTB26155	RTB26255	RTB26355	RTB26455	RTB26555	
		55°	2960 lm	≤ 21	RTB26156	RTB26256	RTB26356	RTB26456	RTB26556	
	3000 K	10 W	15°	918 lm	≤ 19	RTB26101	RTB26201	RTB26301	RTB26401	RTB26501
			24°	924 lm	≤ 19	RTB26103	RTB26203	RTB26303	RTB26403	RTB26503
			38°	926 lm	≤ 19	RTB26105	RTB26205	RTB26305	RTB26405	RTB26505
			55°	930 lm	≤ 19	RTB26107	RTB26207	RTB26307	RTB26407	RTB26507
15 W		15°	1408 lm	≤ 17	RTB26109	RTB26209	RTB26309	RTB26409	RTB26509	
		24°	1412 lm	≤ 17	RTB26111	RTB26211	RTB26311	RTB26411	RTB26511	
		38°	1420 lm	≤ 19	RTB26113	RTB26213	RTB26313	RTB26413	RTB26513	
		55°	1432 lm	≤ 19	RTB26115	RTB26215	RTB26315	RTB26415	RTB26515	
24 W		15°	2150 lm	≤ 17	RTB26117	RTB26217	RTB26317	RTB26417	RTB26517	
		24°	2152 lm	≤ 17	RTB26119	RTB26219	RTB26319	RTB26419	RTB26519	
		38°	2158 lm	≤ 19	RTB26121	RTB26221	RTB26321	RTB26421	RTB26521	
		55°	2164 lm	≤ 21	RTB26123	RTB26223	RTB26323	RTB26423	RTB26523	
33 W		15°	3032 lm	≤ 17	RTB26125	RTB26225	RTB26325	RTB26425	RTB26525	
		24°	3040 lm	≤ 17	RTB26127	RTB26227	RTB26327	RTB26427	RTB26527	
		38°	3048 lm	≤ 19	RTB26129	RTB26229	RTB26329	RTB26429	RTB26529	
		55°	3054 lm	≤ 21	RTB26131	RTB26231	RTB26331	RTB26431	RTB26531	
4000 K		10 W	15°	956 lm	≤ 19	RTB26102	RTB26202	RTB26302	RTB26402	RTB26502
			24°	958 lm	≤ 19	RTB26104	RTB26204	RTB26304	RTB26404	RTB26504
			38°	968 lm	≤ 19	RTB26106	RTB26206	RTB26306	RTB26406	RTB26506
			55°	974 lm	≤ 19	RTB26108	RTB26208	RTB26308	RTB26408	RTB26508
	15 W	15°	1486 lm	≤ 17	RTB26110	RTB26210	RTB26310	RTB26410	RTB26510	
		24°	1494 lm	≤ 17	RTB26112	RTB26212	RTB26312	RTB26412	RTB26512	
		38°	1500 lm	≤ 19	RTB26114	RTB26214	RTB26314	RTB26414	RTB26514	
		55°	1502 lm	≤ 19	RTB26116	RTB26216	RTB26316	RTB26416	RTB26516	
	24 W	15°	2210 lm	≤ 17	RTB26118	RTB26218	RTB26318	RTB26418	RTB26518	
		24°	2218 lm	≤ 17	RTB26120	RTB26220	RTB26320	RTB26420	RTB26520	
		38°	2226 lm	≤ 19	RTB26122	RTB26222	RTB26322	RTB26422	RTB26522	
		55°	2234 lm	≤ 21	RTB26124	RTB26224	RTB26324	RTB26424	RTB26524	
	33 W	15°	3116 lm	≤ 17	RTB26126	RTB26226	RTB26326	RTB26426	RTB26526	
		24°	3120 lm	≤ 17	RTB26128	RTB26228	RTB26328	RTB26428	RTB26528	
		38°	3128 lm	≤ 19	RTB26130	RTB26230	RTB26330	RTB26430	RTB26530	
		55°	3134 lm	≤ 21	RTB26132	RTB26232	RTB26332	RTB26432	RTB26532	





Nemo Comfort



□ IP40 ^{UP TO} 96 lm/W L80/B20 50.000 h. CRI > 90 SDCM < 3   5 YEARS WARRANTY

Nemo Comfort è la soluzione ideale per le installazioni che devono garantire il massimo comfort visivo; grazie al suo cut off a 48° e alla sua gamma di riflettori satinati, la versione Comfort della serie Nemo garantisce il massimo controllo dell'abbagliamento diretto. I moduli illuminanti sono tutti equipaggiati con led di ultima generazione con CRI > 90 e SDCM < 3. I collari decorativi intercambiabili disponibili in quattro diverse finiture satinare permettono di caratterizzare esteticamente l'impianto anche successivamente alla prima installazione senza alterare la performance illuminotecnica. Il cavetto di sicurezza in dotazione evita la caduta accidentale e il sistema di connessione al driver di tipo "fast plug" permette un'installazione rapida e sicura.

Nemo Comfort is the ideal solution for installations with maximum visual comfort; thanks to its 48 ° cut off and its range of satin reflectors, Nemo Comfort guarantees maximum control of direct glare. The lighting modules are all equipped with the latest generation of LEDs (CRI > 90 and SDCM < 3). The interchangeable decorative collars are available in four different satin finishes and allow you to aesthetically characterize the system even after the first installation without changing the lighting performance. The safety cable supplied prevents accidental fall and the "fast plug" connection system to the driver allows quick and safe installation.















- Alimentazione 220÷240 V / 50÷60 Hz - Classe "II"
- Driver remoto con connessione "fast plug"
- Alimentazioni: On / Off, Dimmerabile Multifunzione (Push / 1...10 V), DALI.
- Kit emergenza 1h / 3h. accessorio remoto
- Versioni con controllo digitale "Casambi" o "Pan Digital System"
- Installazione in controsoffitti con spessori da 5 mm. a 25 mm.
- Cavetto di sicurezza incluso premontato
- Anello strutturale tondo e quadrato: colori bianco opaco e nero opaco.
- Collare decorativo intercambiabile disponibile in finiture Matt Silver, Matt White, Matt Black, Matt Bronze.
- IP40 vano ottico; IP20 vano incassato
- Led CoB 2700 K / 3000 K / 4000 K con resa cromatica CRI > 90 e MacAdam SDCM < 3
- No UV, No IR
- Emissioni luminose da 880 lm a 3880 lumen
- Efficacia luminosa fino a 100 lm/W
- Efficienza energetica A
- Lifetime L80 / B20 – 50.000 h
- Lenti ottiche da 15° / 24° / 38° / 55° intercambiabili (ricambi)
- Cut-off 48°
- UGR < 17 / < 19 / < 21
- Classe "II"
- Temperatura ambiente di esercizio da -20°C a +45°C
- Certificazione CE, RoHS
- 5 anni di garanzia

- *Feeding 220÷240 V / 50÷60 Hz - Class "II"*
- *Remote driver with "fast plug" connectors*
- *Switching: On / Off, Multifunction Dimmable (Push / 1... 10 V), DALI.*
- *Emergency Kit 1h / 3h as remote accessory*
- *Digital Control Versions "Casambi" or "Pan Digital System"*
- *Mounting on false ceiling depth from 5 mm. up to 25 mm.*
- *Safe cable included pre-mounted*
- *Rounded or squared ring; color matt white or matt black.*
- *Decorative collars interchangeable and available in Matt Silver, Matt White, Matt Black, Matt Bronze finishing.*
- *IP40 down; IP20 up*
- *Led CoB 2700K / 3000 K / 4000 K; CRI > 90; MacAdam SDCM < 3*
- *No UV, No IR*
- *Light output from 880 lm up to 3880 lm*
- *Efficacy up to 100 lm/W*
- *Energy Label A*
- *Lifetime L80 / B20 – 50.000 h*
- *Optic lens 15° / 24° / 38° / 55° (interchangable as accessory)*
- *Cut-off 48°*
- *UGR < 17 / < 19 / < 21*
- *Operating from -20°C up to +45°C*
- *Compliance CE, RoHS*
- *5 years warranty*

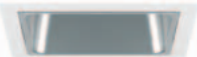
Nemo Comfort

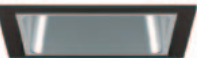
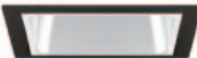

Versioni colore / Color versions











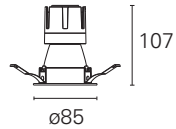

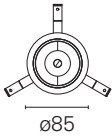

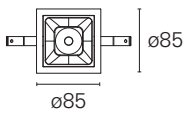

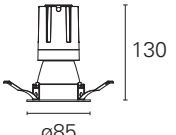

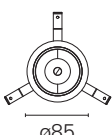

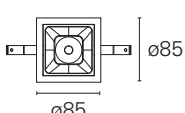

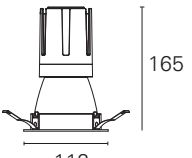

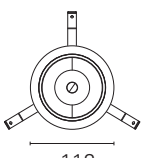

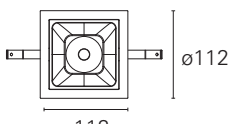

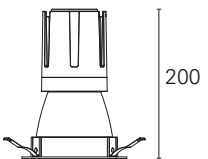

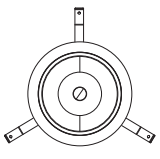
	collari decorativi / decorative collars			
	Satinata <i>Matt</i>	Bianco opaco <i>Matt white</i>	Nero opaco <i>Matt black</i>	Bronzo opaco <i>Matt bronze</i>
anello bianco <i>white ring</i>				
anello nero <i>black ring</i>				
anello bianco <i>white ring</i>				
anello nero <i>black ring</i>				

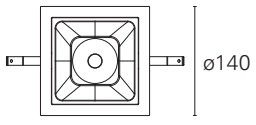
Dimensioni / Dimensions

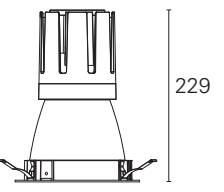
Comfort

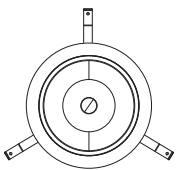
Tondo / *Rounded*

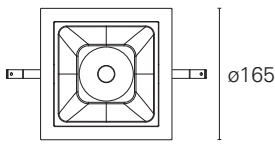
Quadrato / *Squared*

<p>10 W 920 lumen</p>	 <p>107 ø85</p> <p> 0,26</p>	 <p>ø85</p> <p> ø75 mm.</p>	 <p>ø85</p> <p> ø75x75 mm.</p>
<p>15 W 1450 lumen</p>	 <p>130 ø85</p> <p> 0,33</p>	 <p>ø85</p> <p> ø75 mm.</p>	 <p>ø85</p> <p> ø75x75 mm.</p>
<p>24 W 2200 lumen</p>	 <p>165 ø112</p> <p> 0,77</p>	 <p>ø112</p> <p> ø100 mm.</p>	 <p>ø112</p> <p> ø100x100 mm.</p>
<p>33 W 3100 lumen</p>	 <p>200 ø140</p> <p> 0,99</p>	 <p>ø140</p> <p> ø125 mm.</p>	 <p>ø140</p> <p> ø125x125 mm.</p>
<p>42 W 3800 lumen</p>	 <p>229 ø165</p> <p> 1,27</p>	 <p>ø165</p> <p> ø150 mm.</p>	 <p>ø165</p> <p> ø150x150 mm.</p>

Nemo Comfort

anello bianco / *white ring*



Ottiche / Optics

vedi pg. 210 / *see pg. 210*

Ricambi / Spare parts

vedi pg. 284 / *see pg. 284*

Versioni dimmerabili / Dimmable versions

con regolazione via cavo
wired dimmable

versioni <i>version</i>	suffisso codice <i>code suffix</i>	nota <i>note</i>	esempio <i>example</i>
Push 1...10 V	DM	per ordinare la versione PUSH / 1...10 V aggiungere DM alla fine del codice <i>to order the PUSH / 1...10 V version add DM to the end of the code</i>	RTL-----DM
DALI	DA	per ordinare la versione DALI aggiungere DA alla fine del codice <i>to order the DALI version add DA to the end of the code</i>	RTL-----DA

con controllo della luce wireless Bluetooth
wireless Bluetooth lighting control

versioni <i>version</i>	suffisso codice <i>code suffix</i>	nota <i>note</i>	esempio <i>example</i>
PAN Digital	PD	per ordinare la versione per smart application PAN Digital aggiungere PD alla fine del codice <i>to order the version for smart application PAN Digital add PD to the end of the code</i>	RTL-----PD
CASAMBI	CA	per ordinare la versione per smart application CASAMBI aggiungere CA alla fine del codice <i>to order the version for smart application CASAMBI add CA to the end of the code</i>	RTL-----CA

versioni Bluetooth per "smart application"; **vedi dettagli alle pagine 8 - 9**
Bluetooth versions for "smart application"; see details to pages 8 - 9

Kit Emergenza / Emergency Kit

autonomia <i>operation time</i>	tempo di accensione <i>switching time</i>	tempo di ricarica <i>recharging time</i>	foro di incasso minimo (*) <i>minimum recessing hole (*)</i>	IP <i>IP</i>	peso <i>weight</i>	codice <i>code</i>
1 ora / 1 hour	0,5 sec.	24 h.	Ø 75 mm.	IP20	0,43 kg	DRV9092
3 ora / 3 hour	0,5 sec.	24 h.	Ø 100mm.	IP20	0,88 kg	DRV9091

(*) per l'installazione in controsoffitto verificare la compatibilità con il foro di incasso; **vedi dettagli a pagina 546**
() for installation in false ceiling check the compatibility with the recessing hole; see details to page 546*

Nemo Comfort

anello bianco / white ring



CCT CCT	potenza power	ottica optic	flusso effettivo lumen output	UGR UGR	satinata matt	bianco opaco matt white	nero opaco matt black	bronzo opaco matt bronze
2700 K	10 W	15°	876 lm	≤ 17	RTL22141	RTL22241	RTL22341	RTL22441
		24°	882 lm	≤ 17	RTL22142	RTL22242	RTL22342	RTL22442
		38°	879 lm	≤ 17	RTL22143	RTL22243	RTL22343	RTL22443
		55°	886 lm	≤ 17	RTL22144	RTL22244	RTL22344	RTL22444
	15 W	15°	1345 lm	≤ 17	RTL22145	RTL22245	RTL22345	RTL22445
		24°	1349 lm	≤ 17	RTL22146	RTL22246	RTL22346	RTL22446
		38°	1353 lm	≤ 17	RTL22147	RTL22247	RTL22347	RTL22447
		55°	1369 lm	≤ 19	RTL22148	RTL22248	RTL22348	RTL22448
	24 W	15°	2054 lm	≤ 17	RTL22149	RTL22249	RTL22349	RTL22449
		24°	2062 lm	≤ 17	RTL22150	RTL22250	RTL22350	RTL22450
		38°	2076 lm	≤ 17	RTL22151	RTL22251	RTL22351	RTL22451
		55°	2090 lm	≤ 19	RTL22152	RTL22252	RTL22352	RTL22452
	33 W	15°	2926 lm	≤ 17	RTL22153	RTL22253	RTL22353	RTL22453
		24°	2932 lm	≤ 17	RTL22154	RTL22254	RTL22354	RTL22454
		38°	2938 lm	≤ 17	RTL22155	RTL22255	RTL22355	RTL22455
		55°	2946 lm	≤ 21	RTL22156	RTL22256	RTL22356	RTL22456
	42 W	15°	3666 lm	≤ 17	RTL22157	RTL22257	RTL22357	RTL22457
		24°	3670 lm	≤ 17	RTL22158	RTL22258	RTL22358	RTL22458
		38°	3678 lm	≤ 17	RTL22159	RTL22259	RTL22359	RTL22459
		55°	3684 lm	≤ 21	RTL22160	RTL22260	RTL22360	RTL22460
3000 K	10 W	15°	906 lm	≤ 17	RTL22101	RTL22201	RTL22301	RTL22401
		24°	912 lm	≤ 17	RTL22103	RTL22203	RTL22303	RTL22403
		38°	910 lm	≤ 17	RTL22105	RTL22205	RTL22305	RTL22405
		55°	916 lm	≤ 17	RTL22107	RTL22207	RTL22307	RTL22407
	15 W	15°	1394 lm	≤ 17	RTL22109	RTL22209	RTL22309	RTL22409
		24°	1398 lm	≤ 17	RTL22111	RTL22211	RTL22311	RTL22411
		38°	1402 lm	≤ 17	RTL22113	RTL22213	RTL22313	RTL22413
		55°	1418 lm	≤ 19	RTL22115	RTL22215	RTL22315	RTL22415
	24 W	15°	2148 lm	≤ 17	RTL22117	RTL22217	RTL22317	RTL22417
		24°	2156 lm	≤ 17	RTL22119	RTL22219	RTL22319	RTL22419
		38°	2170 lm	≤ 17	RTL22121	RTL22221	RTL22321	RTL22421
		55°	2184 lm	≤ 19	RTL22123	RTL22223	RTL22323	RTL22423
	33 W	15°	3020 lm	≤ 17	RTL22125	RTL22225	RTL22325	RTL22425
		24°	3028 lm	≤ 17	RTL22127	RTL22227	RTL22327	RTL22427
		38°	3032 lm	≤ 17	RTL22129	RTL22229	RTL22329	RTL22429
		55°	3040 lm	≤ 21	RTL22131	RTL22231	RTL22331	RTL22431
	42 W	15°	3768 lm	≤ 17	RTL22133	RTL22233	RTL22333	RTL22433
		24°	3772 lm	≤ 17	RTL22135	RTL22235	RTL22335	RTL22435
		38°	3780 lm	≤ 17	RTL22137	RTL22237	RTL22337	RTL22437
		55°	3786 lm	≤ 21	RTL22139	RTL22239	RTL22339	RTL22439
4000 K	10 W	15°	948 lm	≤ 17	RTL22102	RTL22202	RTL22302	RTL22402
		24°	950 lm	≤ 17	RTL22104	RTL22204	RTL22304	RTL22404
		38°	956 lm	≤ 17	RTL22106	RTL22206	RTL22306	RTL22406
		55°	968 lm	≤ 17	RTL22108	RTL22208	RTL22308	RTL22408
	15 W	15°	1430 lm	≤ 17	RTL22110	RTL22210	RTL22310	RTL22410
		24°	1436 lm	≤ 17	RTL22112	RTL22212	RTL22312	RTL22412
		38°	1440 lm	≤ 17	RTL22114	RTL22214	RTL22314	RTL22414
		55°	1452 lm	≤ 19	RTL22116	RTL22216	RTL22316	RTL22416
	24 W	15°	2180 lm	≤ 17	RTL22118	RTL22218	RTL22318	RTL22418
		24°	2192 lm	≤ 17	RTL22120	RTL22220	RTL22320	RTL22420
		38°	2212 lm	≤ 17	RTL22122	RTL22222	RTL22322	RTL22422
		55°	2224 lm	≤ 19	RTL22124	RTL22224	RTL22324	RTL22424
	33 W	15°	3072 lm	≤ 17	RTL22126	RTL22226	RTL22326	RTL22426
		24°	3082 lm	≤ 17	RTL22128	RTL22228	RTL22328	RTL22428
		38°	3094 lm	≤ 17	RTL22130	RTL22230	RTL22330	RTL22430
		55°	3098 lm	≤ 21	RTL22132	RTL22232	RTL22332	RTL22432
	42 W	15°	3806 lm	≤ 17	RTL22134	RTL22234	RTL22334	RTL22434
		24°	3824 lm	≤ 17	RTL22136	RTL22236	RTL22336	RTL22436
		38°	3834 lm	≤ 17	RTL22138	RTL22238	RTL22338	RTL22438
		55°	3844 lm	≤ 21	RTL22140	RTL22240	RTL22340	RTL22440

Nemo Comfort

anello nero / *black ring*



Ottiche / Optics

vedi pg. 210 / *see pg. 210*

Ricambi / Spare parts

vedi pg. 284 / *see pg. 284*

Versioni dimmerabili / Dimmable versions

con regolazione via cavo
wired dimmable

versioni <i>version</i>	suffisso codice <i>code suffix</i>	nota <i>note</i>	esempio <i>example</i>
Push 1...10 V	DM	per ordinare la versione PUSH / 1...10 V aggiungere DM alla fine del codice <i>to order the PUSH / 1...10 V version add DM to the end of the code</i>	RTB-----DM
DALI	DA	per ordinare la versione DALI aggiungere DA alla fine del codice <i>to order the DALI version add DA to the end of the code</i>	RTB-----DA

con controllo della luce wireless Bluetooth
wireless Bluetooth lighting control

versioni <i>version</i>	suffisso codice <i>code suffix</i>	nota <i>note</i>	esempio <i>example</i>
PAN Digital	PD	per ordinare la versione per smart application PAN Digital aggiungere PD alla fine del codice <i>to order the version for smart application PAN Digital add PD to the end of the code</i>	RTB-----PD
CASAMBI	CA	per ordinare la versione per smart application CASAMBI aggiungere CA alla fine del codice <i>to order the version for smart application CASAMBI add CA to the end of the code</i>	RTB-----CA

versioni Bluetooth per "smart application"; **vedi dettagli alle pagine 8 - 9**
Bluetooth versions for "smart application"; see details to pages 8 - 9

Kit Emergenza / Emergency Kit

autonomia <i>operation time</i>	tempo di accensione <i>switching time</i>	tempo di ricarica <i>recharging time</i>	foro di incasso minimo (*) <i>minimum recessing hole (*)</i>	IP <i>IP</i>	peso <i>weight</i>	codice <i>code</i>
1 ora / 1 hour	0,5 sec.	24 h.	Ø 75 mm.	IP20	0,43 kg	DRV9092
3 ora / 3 hour	0,5 sec.	24 h.	Ø 100mm.	IP20	0,88 kg	DRV9091

(*) per l'installazione in controsoffitto verificare la compatibilità con il foro di incasso; **vedi dettagli a pagina 546**
() for installation in false ceiling check the compatibility with the recessing hole; see details to page 546*



CCT CCT	potenza power	ottica optic	flusso effettivo lumen output	UGR UGR	satinata matt	bianco opaco matt white	nero opaco matt black	bronzo opaco matt bronze
2700 K	10 W	15°	876 lm	≤ 17	RTB22141	RTB22241	RTB22341	RTB22441
		24°	882 lm	≤ 17	RTB22142	RTB22242	RTB22342	RTB22442
		38°	879 lm	≤ 17	RTB22143	RTB22243	RTB22343	RTB22443
		55°	886 lm	≤ 17	RTB22144	RTB22244	RTB22344	RTB22444
	15 W	15°	1345 lm	≤ 17	RTB22145	RTB22245	RTB22345	RTB22445
		24°	1349 lm	≤ 17	RTB22146	RTB22246	RTB22346	RTB22446
		38°	1353 lm	≤ 17	RTB22147	RTB22247	RTB22347	RTB22447
		55°	1369 lm	≤ 19	RTB22148	RTB22248	RTB22348	RTB22448
	24 W	15°	2054 lm	≤ 17	RTB22149	RTB22249	RTB22349	RTB22449
		24°	2062 lm	≤ 17	RTB22150	RTB22250	RTB22350	RTB22450
		38°	2076 lm	≤ 17	RTB22151	RTB22251	RTB22351	RTB22451
		55°	2090 lm	≤ 19	RTB22152	RTB22252	RTB22352	RTB22452
	33 W	15°	2926 lm	≤ 17	RTB22153	RTB22253	RTB22353	RTB22453
		24°	2932 lm	≤ 17	RTB22154	RTB22254	RTB22354	RTB22454
		38°	2938 lm	≤ 17	RTB22155	RTB22255	RTB22355	RTB22455
		55°	2946 lm	≤ 21	RTB22156	RTB22256	RTB22356	RTB22456
	42 W	15°	3666 lm	≤ 17	RTB22157	RTB22257	RTB22357	RTB22457
		24°	3670 lm	≤ 17	RTB22158	RTB22258	RTB22358	RTB22458
		38°	3678 lm	≤ 17	RTB22159	RTB22259	RTB22359	RTB22459
		55°	3684 lm	≤ 21	RTB22160	RTB22260	RTB22360	RTB22460
3000 K	10 W	15°	906 lm	≤ 17	RTB22101	RTB22201	RTB22301	RTB22401
		24°	912 lm	≤ 17	RTB22103	RTB22203	RTB22303	RTB22403
		38°	910 lm	≤ 17	RTB22105	RTB22205	RTB22305	RTB22405
		55°	916 lm	≤ 17	RTB22107	RTB22207	RTB22307	RTB22407
	15 W	15°	1394 lm	≤ 17	RTB22109	RTB22209	RTB22309	RTB22409
		24°	1398 lm	≤ 17	RTB22111	RTB22211	RTB22311	RTB22411
		38°	1402 lm	≤ 17	RTB22113	RTB22213	RTB22313	RTB22413
		55°	1418 lm	≤ 19	RTB22115	RTB22215	RTB22315	RTB22415
	24 W	15°	2148 lm	≤ 17	RTB22117	RTB22217	RTB22317	RTB22417
		24°	2156 lm	≤ 17	RTB22119	RTB22219	RTB22319	RTB22419
		38°	2170 lm	≤ 17	RTB22121	RTB22221	RTB22321	RTB22421
		55°	2184 lm	≤ 19	RTB22123	RTB22223	RTB22323	RTB22423
	33 W	15°	3020 lm	≤ 17	RTB22125	RTB22225	RTB22325	RTB22425
		24°	3028 lm	≤ 17	RTB22127	RTB22227	RTB22327	RTB22427
		38°	3032 lm	≤ 17	RTB22129	RTB22229	RTB22329	RTB22429
		55°	3040 lm	≤ 21	RTB22131	RTB22231	RTB22331	RTB22431
	42 W	15°	3768 lm	≤ 17	RTB22133	RTB22233	RTB22333	RTB22433
		24°	3772 lm	≤ 17	RTB22135	RTB22235	RTB22335	RTB22435
		38°	3780 lm	≤ 17	RTB22137	RTB22237	RTB22337	RTB22437
		55°	3786 lm	≤ 21	RTB22139	RTB22239	RTB22339	RTB22439
4000 K	10 W	15°	948 lm	≤ 17	RTB22102	RTB22202	RTB22302	RTB22402
		24°	950 lm	≤ 17	RTB22104	RTB22204	RTB22304	RTB22404
		38°	956 lm	≤ 17	RTB22106	RTB22206	RTB22306	RTB22406
		55°	968 lm	≤ 17	RTB22108	RTB22208	RTB22308	RTB22408
	15 W	15°	1430 lm	≤ 17	RTB22110	RTB22210	RTB22310	RTB22410
		24°	1436 lm	≤ 17	RTB22112	RTB22212	RTB22312	RTB22412
		38°	1440 lm	≤ 17	RTB22114	RTB22214	RTB22314	RTB22414
		55°	1452 lm	≤ 19	RTB22116	RTB22216	RTB22316	RTB22416
	24 W	15°	2180 lm	≤ 17	RTB22118	RTB22218	RTB22318	RTB22418
		24°	2192 lm	≤ 17	RTB22120	RTB22220	RTB22320	RTB22420
		38°	2212 lm	≤ 17	RTB22122	RTB22222	RTB22322	RTB22422
		55°	2224 lm	≤ 19	RTB22124	RTB22224	RTB22324	RTB22424
	33 W	15°	3072 lm	≤ 17	RTB22126	RTB22226	RTB22326	RTB22426
		24°	3082 lm	≤ 17	RTB22128	RTB22228	RTB22328	RTB22428
		38°	3094 lm	≤ 17	RTB22130	RTB22230	RTB22330	RTB22430
		55°	3098 lm	≤ 21	RTB22132	RTB22232	RTB22332	RTB22432
	42 W	15°	3806 lm	≤ 17	RTB22134	RTB22234	RTB22334	RTB22434
		24°	3824 lm	≤ 17	RTB22136	RTB22236	RTB22336	RTB22436
		38°	3834 lm	≤ 17	RTB22138	RTB22238	RTB22338	RTB22438
		55°	3844 lm	≤ 21	RTB22140	RTB22240	RTB22340	RTB22440





Nemo Comfort

anello bianco / *white ring*



Ottiche / Optics

vedi pg. 210 / *see pg. 210*

Ricambi / Spare parts

vedi pg. 284 / *see pg. 284*

Versioni dimmerabili / Dimmable versions

con regolazione via cavo
wired dimmable

versioni <i>version</i>	suffisso codice <i>code suffix</i>	nota <i>note</i>	esempio <i>example</i>
Push 1...10 V	DM	per ordinare la versione PUSH / 1...10 V aggiungere DM alla fine del codice <i>to order the PUSH / 1...10 V version add DM to the end of the code</i>	RTL-----DM
DALI	DA	per ordinare la versione DALI aggiungere DA alla fine del codice <i>to order the DALI version add DA to the end of the code</i>	RTL-----DA

con controllo della luce wireless Bluetooth
wireless Bluetooth lighting control

versioni <i>version</i>	suffisso codice <i>code suffix</i>	nota <i>note</i>	esempio <i>example</i>
PAN Digital	PD	per ordinare la versione per smart application PAN Digital aggiungere PD alla fine del codice <i>to order the version for smart application PAN Digital add PD to the end of the code</i>	RTL-----PD
CASAMBI	CA	per ordinare la versione per smart application CASAMBI aggiungere CA alla fine del codice <i>to order the version for smart application CASAMBI add CA to the end of the code</i>	RTL-----CA

versioni Bluetooth per "smart application"; **vedi dettagli alle pagine 8 - 9**
Bluetooth versions for "smart application"; see details to pages 8 - 9

Kit Emergenza / Emergency Kit

autonomia <i>operation time</i>	tempo di accensione <i>switching time</i>	tempo di ricarica <i>recharging time</i>	foro di incasso minimo (*) <i>minimum recessing hole (*)</i>	IP <i>IP</i>	peso <i>weight</i>	codice <i>code</i>
1 ora / 1 hour	0,5 sec.	24 h.	Ø 75 mm.	IP20	0,43 kg	DRV9092
3 ora / 3 hour	0,5 sec.	24 h.	Ø 100mm.	IP20	0,88 kg	DRV9091

(*) per l'installazione in controsoffitto verificare la compatibilità con il foro di incasso; **vedi dettagli a pagina 546**
() for installation in false ceiling check the compatibility with the recessing hole; see details to page 546*



CCT CCT	potenza power	ottica optic	flusso effettivo lumen output	UGR UGR	satinata matt	bianco opaco matt white	nero opaco matt black	bronzo opaco matt bronze
2700 K	10 W	15°	876 lm	≤ 17	RTL27141	RTL27241	RTL27341	RTL27441
		24°	882 lm	≤ 17	RTL27142	RTL27242	RTL27342	RTL27442
		38°	879 lm	≤ 17	RTL27143	RTL27243	RTL27343	RTL27443
		55°	886 lm	≤ 17	RTL27144	RTL27244	RTL27344	RTL27444
	15 W	15°	1345 lm	≤ 17	RTL27145	RTL27245	RTL27345	RTL27445
		24°	1349 lm	≤ 17	RTL27146	RTL27246	RTL27346	RTL27446
		38°	1353 lm	≤ 17	RTL27147	RTL27247	RTL27347	RTL27447
		55°	1369 lm	≤ 19	RTL27148	RTL27248	RTL27348	RTL27448
	24 W	15°	2054 lm	≤ 17	RTL27149	RTL27249	RTL27349	RTL27449
		24°	2062 lm	≤ 17	RTL27150	RTL27250	RTL27350	RTL27450
		38°	2076 lm	≤ 17	RTL27151	RTL27251	RTL27351	RTL27451
		55°	2090 lm	≤ 19	RTL27152	RTL27252	RTL27352	RTL27452
	33 W	15°	2926 lm	≤ 17	RTL27153	RTL27253	RTL27353	RTL27453
		24°	2932 lm	≤ 17	RTL27154	RTL27254	RTL27354	RTL27454
		38°	2938 lm	≤ 17	RTL27155	RTL27255	RTL27355	RTL27455
		55°	2946 lm	≤ 21	RTL27156	RTL27256	RTL27356	RTL27456
	42 W	15°	3666 lm	≤ 17	RTL27157	RTL27257	RTL27357	RTL27457
		24°	3670 lm	≤ 17	RTL27158	RTL27258	RTL27358	RTL27458
		38°	3678 lm	≤ 17	RTL27159	RTL27259	RTL27359	RTL27459
		55°	3684 lm	≤ 21	RTL27160	RTL27260	RTL27360	RTL27460
3000 K	10 W	15°	906 lm	≤ 17	RTL27101	RTL27201	RTL27301	RTL27401
		24°	912 lm	≤ 17	RTL27103	RTL27203	RTL27303	RTL27403
		38°	910 lm	≤ 17	RTL27105	RTL27205	RTL27305	RTL27405
		55°	916 lm	≤ 17	RTL27107	RTL27207	RTL27307	RTL27407
	15 W	15°	1394 lm	≤ 17	RTL27109	RTL27209	RTL27309	RTL27409
		24°	1398 lm	≤ 17	RTL27111	RTL27211	RTL27311	RTL27411
		38°	1402 lm	≤ 17	RTL27113	RTL27213	RTL27313	RTL27413
		55°	1418 lm	≤ 19	RTL27115	RTL27215	RTL27315	RTL27415
	24 W	15°	2148 lm	≤ 17	RTL27117	RTL27217	RTL27317	RTL27417
		24°	2156 lm	≤ 17	RTL27119	RTL27219	RTL27319	RTL27419
		38°	2170 lm	≤ 17	RTL27121	RTL27221	RTL27321	RTL27421
		55°	2184 lm	≤ 19	RTL27123	RTL27223	RTL27323	RTL27423
	33 W	15°	3020 lm	≤ 17	RTL27125	RTL27225	RTL27325	RTL27425
		24°	3028 lm	≤ 17	RTL27127	RTL27227	RTL27327	RTL27427
		38°	3032 lm	≤ 17	RTL27129	RTL27229	RTL27329	RTL27429
		55°	3040 lm	≤ 21	RTL27131	RTL27231	RTL27331	RTL27431
	42 W	15°	3768 lm	≤ 17	RTL27133	RTL27233	RTL27333	RTL27433
		24°	3772 lm	≤ 17	RTL27135	RTL27235	RTL27335	RTL27435
		38°	3780 lm	≤ 17	RTL27137	RTL27237	RTL27337	RTL27437
		55°	3786 lm	≤ 21	RTL27139	RTL27239	RTL27339	RTL27439
4000 K	10 W	15°	948 lm	≤ 17	RTL27102	RTL27202	RTL27302	RTL27402
		24°	950 lm	≤ 17	RTL27104	RTL27204	RTL27304	RTL27404
		38°	956 lm	≤ 17	RTL27106	RTL27206	RTL27306	RTL27406
		55°	968 lm	≤ 17	RTL27108	RTL27208	RTL27308	RTL27408
	15 W	15°	1430 lm	≤ 17	RTL27110	RTL27210	RTL27310	RTL27410
		24°	1436 lm	≤ 17	RTL27112	RTL27212	RTL27312	RTL27412
		38°	1440 lm	≤ 17	RTL27114	RTL27214	RTL27314	RTL27414
		55°	1452 lm	≤ 19	RTL27116	RTL27216	RTL27316	RTL27416
	24 W	15°	2180 lm	≤ 17	RTL27118	RTL27218	RTL27318	RTL27418
		24°	2192 lm	≤ 17	RTL27120	RTL27220	RTL27320	RTL27420
		38°	2212 lm	≤ 17	RTL27122	RTL27222	RTL27322	RTL27422
		55°	2224 lm	≤ 19	RTL27124	RTL27224	RTL27324	RTL27424
	33 W	15°	3072 lm	≤ 17	RTL27126	RTL27226	RTL27326	RTL27426
		24°	3082 lm	≤ 17	RTL27128	RTL27228	RTL27328	RTL27428
		38°	3094 lm	≤ 17	RTL27130	RTL27230	RTL27330	RTL27430
		55°	3098 lm	≤ 21	RTL27132	RTL27232	RTL27332	RTL27432
	42 W	15°	3806 lm	≤ 17	RTL27134	RTL27234	RTL27334	RTL27434
		24°	3824 lm	≤ 17	RTL27136	RTL27236	RTL27336	RTL27436
		38°	3834 lm	≤ 17	RTL27138	RTL27238	RTL27338	RTL27438
		55°	3844 lm	≤ 21	RTL27140	RTL27240	RTL27340	RTL27440

Nemo Comfort

anello nero / *black ring*



Ottiche / Optics

vedi pg. 210 / *see pg. 210*

Ricambi / Spare parts

vedi pg. 284 / *see pg. 284*

Versioni dimmerabili / Dimmable versions

con regolazione via cavo
wired dimmable

versioni <i>version</i>	suffisso codice <i>code suffix</i>	nota <i>note</i>	esempio <i>example</i>
Push 1...10 V	DM	per ordinare la versione PUSH / 1...10 V aggiungere DM alla fine del codice <i>to order the PUSH / 1...10 V version add DM to the end of the code</i>	RTL-----DM
DALI	DA	per ordinare la versione DALI aggiungere DA alla fine del codice <i>to order the DALI version add DA to the end of the code</i>	RTL-----DA

con controllo della luce wireless Bluetooth
wireless Bluetooth lighting control

versioni <i>version</i>	suffisso codice <i>code suffix</i>	nota <i>note</i>	esempio <i>example</i>
PAN Digital	PD	per ordinare la versione per smart application PAN Digital aggiungere PD alla fine del codice <i>to order the version for smart application PAN Digital add PD to the end of the code</i>	RTL-----PD
CASAMBI	CA	per ordinare la versione per smart application CASAMBI aggiungere CA alla fine del codice <i>to order the version for smart application CASAMBI add CA to the end of the code</i>	RTL-----CA

versioni Bluetooth per "smart application"; **vedi dettagli alle pagine 8 - 9**
Bluetooth versions for "smart application"; see details to pages 8 - 9

Kit Emergenza / Emergency Kit

autonomia <i>operation time</i>	tempo di accensione <i>switching time</i>	tempo di ricarica <i>recharging time</i>	foro di incasso minimo (*) <i>minimum recessing hole (*)</i>	IP <i>IP</i>	peso <i>weight</i>	codice <i>code</i>
1 ora / 1 hour	0,5 sec.	24 h.	Ø 75 mm.	IP20	0,43 kg	DRV9092
3 ora / 3 hour	0,5 sec.	24 h.	Ø 100mm.	IP20	0,88 kg	DRV9091

(*) per l'installazione in controsoffitto verificare la compatibilità con il foro di incasso; **vedi dettagli a pagina 546**
() for installation in false ceiling check the compatibility with the recessing hole; see details to page 546*



CCT CCT	potenza power	ottica optic	flusso effettivo lumen output	UGR UGR	satinata matt	bianco opaco matt white	nero opaco matt black	bronzo opaco matt bronze
2700 K	10 W	15°	876 lm	≤ 17	RTB27141	RTB27241	RTB27341	RTB27441
		24°	882 lm	≤ 17	RTB27142	RTB27242	RTB27342	RTB27442
		38°	879 lm	≤ 17	RTB27143	RTB27243	RTB27343	RTB27443
		55°	886 lm	≤ 17	RTB27144	RTB27244	RTB27344	RTB27444
	15 W	15°	1345 lm	≤ 17	RTB27145	RTB27245	RTB27345	RTB27445
		24°	1349 lm	≤ 17	RTB27146	RTB27246	RTB27346	RTB27446
		38°	1353 lm	≤ 17	RTB27147	RTB27247	RTB27347	RTB27447
		55°	1369 lm	≤ 19	RTB27148	RTB27248	RTB27348	RTB27448
	24 W	15°	2054 lm	≤ 17	RTB27149	RTB27249	RTB27349	RTB27449
		24°	2062 lm	≤ 17	RTB27150	RTB27250	RTB27350	RTB27450
		38°	2076 lm	≤ 17	RTB27151	RTB27251	RTB27351	RTB27451
		55°	2090 lm	≤ 19	RTB27152	RTB27252	RTB27352	RTB27452
	33 W	15°	2926 lm	≤ 17	RTB27153	RTB27253	RTB27353	RTB27453
		24°	2932 lm	≤ 17	RTB27154	RTB27254	RTB27354	RTB27454
		38°	2938 lm	≤ 17	RTB27155	RTB27255	RTB27355	RTB27455
		55°	2946 lm	≤ 21	RTB27156	RTB27256	RTB27356	RTB27456
	42 W	15°	3666 lm	≤ 17	RTB27157	RTB27257	RTB27357	RTB27457
		24°	3670 lm	≤ 17	RTB27158	RTB27258	RTB27358	RTB27458
		38°	3678 lm	≤ 17	RTB27159	RTB27259	RTB27359	RTB27459
		55°	3684 lm	≤ 21	RTB27160	RTB27260	RTB27360	RTB27460
3000 K	10 W	15°	906 lm	≤ 17	RTB27101	RTB27201	RTB27301	RTB27401
		24°	912 lm	≤ 17	RTB27103	RTB27203	RTB27303	RTB27403
		38°	910 lm	≤ 17	RTB27105	RTB27205	RTB27305	RTB27405
		55°	916 lm	≤ 17	RTB27107	RTB27207	RTB27307	RTB27407
	15 W	15°	1394 lm	≤ 17	RTB27109	RTB27209	RTB27309	RTB27409
		24°	1398 lm	≤ 17	RTB27111	RTB27211	RTB27311	RTB27411
		38°	1402 lm	≤ 17	RTB27113	RTB27213	RTB27313	RTB27413
		55°	1418 lm	≤ 19	RTB27115	RTB27215	RTB27315	RTB27415
	24 W	15°	2148 lm	≤ 17	RTB27117	RTB27217	RTB27317	RTB27417
		24°	2156 lm	≤ 17	RTB27119	RTB27219	RTB27319	RTB27419
		38°	2170 lm	≤ 17	RTB27121	RTB27221	RTB27321	RTB27421
		55°	2184 lm	≤ 19	RTB27123	RTB27223	RTB27323	RTB27423
	33 W	15°	3020 lm	≤ 17	RTB27125	RTB27225	RTB27325	RTB27425
		24°	3028 lm	≤ 17	RTB27127	RTB27227	RTB27327	RTB27427
		38°	3032 lm	≤ 17	RTB27129	RTB27229	RTB27329	RTB27429
		55°	3040 lm	≤ 21	RTB27131	RTB27231	RTB27331	RTB27431
	42 W	15°	3768 lm	≤ 17	RTB27133	RTB27233	RTB27333	RTB27433
		24°	3772 lm	≤ 17	RTB27135	RTB27235	RTB27335	RTB27435
		38°	3780 lm	≤ 17	RTB27137	RTB27237	RTB27337	RTB27437
		55°	3786 lm	≤ 21	RTB27139	RTB27239	RTB27339	RTB27439
4000 K	10 W	15°	948 lm	≤ 17	RTB27102	RTB27202	RTB27302	RTB27402
		24°	950 lm	≤ 17	RTB27104	RTB27204	RTB27304	RTB27404
		38°	956 lm	≤ 17	RTB27106	RTB27206	RTB27306	RTB27406
		55°	968 lm	≤ 17	RTB27108	RTB27208	RTB27308	RTB27408
	15 W	15°	1430 lm	≤ 17	RTB27110	RTB27210	RTB27310	RTB27410
		24°	1436 lm	≤ 17	RTB27112	RTB27212	RTB27312	RTB27412
		38°	1440 lm	≤ 17	RTB27114	RTB27214	RTB27314	RTB27414
		55°	1452 lm	≤ 19	RTB27116	RTB27216	RTB27316	RTB27416
	24 W	15°	2180 lm	≤ 17	RTB27118	RTB27218	RTB27318	RTB27418
		24°	2192 lm	≤ 17	RTB27120	RTB27220	RTB27320	RTB27420
		38°	2212 lm	≤ 17	RTB27122	RTB27222	RTB27322	RTB27422
		55°	2224 lm	≤ 19	RTB27124	RTB27224	RTB27324	RTB27424
	33 W	15°	3072 lm	≤ 17	RTB27126	RTB27226	RTB27326	RTB27426
		24°	3082 lm	≤ 17	RTB27128	RTB27228	RTB27328	RTB27428
		38°	3094 lm	≤ 17	RTB27130	RTB27230	RTB27330	RTB27430
		55°	3098 lm	≤ 21	RTB27132	RTB27232	RTB27332	RTB27432
	42 W	15°	3806 lm	≤ 17	RTB27134	RTB27234	RTB27334	RTB27434
		24°	3824 lm	≤ 17	RTB27136	RTB27236	RTB27336	RTB27436
		38°	3834 lm	≤ 17	RTB27138	RTB27238	RTB27338	RTB27438
		55°	3844 lm	≤ 21	RTB27140	RTB27240	RTB27340	RTB27440

Nemo TL Adj / Fix



Adj



Fix

□ IP40 ^{UP TO} 100 lm/W L80/B20 50.000h. CRI > 90 SDCM < 3   5 YEARS WARRANTY

Nemo TL è la serie trimless della famiglia Nemo progettata per le installazioni nei controsoffitti in cartongesso senza bordo a vista. I modelli fino a 24W sono dotati di flangia fissa preforata per il fissaggio diretto dell'apparecchio al controsoffitto; I modelli da 33W e 42W sono dotati di flange di fissaggio regolabili in altezza. Quattro aperture di fascio con cut-off di 38° e versioni fino a UGR<17 permettono di ottenere il giusto equilibrio fra controllo delle luminanze e diffusione della luce. I moduli illuminanti sono tutti equipaggiati con led di ultima generazione con CRI > 90 e SDCM < 3. La gamma di Nemo TL Adj e Nemo TL Fix presenta collari decorativi intercambiabili disponibili in cinque diverse finiture estetiche che permettono di caratterizzare l'impianto anche successivamente alla prima installazione. Il cavetto di sicurezza in dotazione evita la caduta accidentale e il sistema di connessione al driver di tipo "fast plug" permette un'installazione rapida e sicura. Versione Nemo ADJ per luce di accento con orientabilità di 350° sul piano orizzontale e di 30° sul piano verticale. Nemo Fix per l'illuminazione verticale per il controllo dell'abbagliamento diretto e luce sfumata ai bordi del fascio.

Nemo TL is the trimless series of the Nemo family designed for installations in plasterboard false ceilings with no visible edge. Models up to 24W are equipped with a pre-drilled fixed frame for direct fixing of the luminaire to the false ceiling; The 33W and 42W models are equipped with height-adjustable fixing frame. Four beam openings with 38 ° cut-off and versions up to UGR <17 allow to obtain the right balance between luminance control and light diffusion. The lighting modules are all equipped with latest generation LEDs with CRI> 90 and SDCM <3. The range of Nemo TL Adj and Nemo TL Fix has interchangeable decorative collars available in five different aesthetic finishes that allow the system to be characterized even after the first installation. The safety cable supplied prevents accidental drops and the "fast plug" connection system to the driver allows quick and safe installation. Nemo ADJ version for accent lighting with 350 ° adjustability on the horizontal plane and 30 ° on the vertical plane. Nemo Fix is perfect for vertical lighting for the control of direct glare and soft light at the edges of the beam.



- Alimentazione 220÷240 V / 50÷60 Hz - Classe "II"
- Driver remoto con connessione "fast plug"
- Alimentazioni: On / Off, Dimmerabile Multifunzione (Push / 1...10 V), DALI.
- Kit emergenza 1h / 3h. accessorio remoto.
- Versioni con controllo digitale "Casambi" o "Pan Digital System"
- Installazione "trimless" in controsoffitto. Anello con flangia fissa preforata per versioni fino a 24 W.
- Anello con flange regolabili per versioni da 33W a 42W.
- Installazione in controsoffitti con spessori da 5 mm. a 25 mm per versioni 33W / 42W .
- Cavetto di sicurezza incluso premontato.
- Versioni fisse e orientabili: 350° rotazione orizzontale con stop e 90° inclinazione verticale
- Collare decorativo intercambiabile disponibile in finiture Matt, Mirror, White, Titanium, Gold.
- IP40 vano ottico; IP20 vano incassato
- Led CoB 2700 K / 3000 K / 4000 K con resa cromatica CRI > 90 e MacAdam SDCM < 3
- No UV, No IR
- Emissioni luminose da 890 lm a 3880 lumen
- Efficacia luminosa fino a 100 lm/W
- Efficienza energetica A
- Lifetime L80 / B20 – 50.000 h
- Lenti ottiche da 15° / 24° / 38° / 55° intercambiabili (ricambi)
- Cut-off 38°
- UGR < 17 / < 19 / < 21
- Classe "II"
- Temperatura ambiente di esercizio da -20°C a +45°C
- Certificazione CE, RoHS
- 5 anni di garanzia

- *Feeding 220÷240 V / 50÷60 Hz - Class "II"*
- *Remote driver with "fast plug" connectors*
- *Switching: On / Off, Multifunction Dimmable (Push / 1...10 V), DALI.*
- *Emergency Kit 1h / 3h as remote accessory.*
- *Digital Control Versions "Casambi" or "Pan Digital System"*
- *Trimless mounting for plaster false ceiling. Ring with fixed pre-drilled flange for model up to 24 W.*
- *Ring with adjustable height pre-drilled flange for model from 33W to 42W.*
- *Mounting on false ceiling depth from 5 mm. up to 25 mm for model from 33W to 42W.*
- *Safe cable included pre-mounted*
- *Fixed and Adjustable versions: 350° horizontal rotation with stop, 90° vertical rotation*
- *Decorative collars interchangeable and available in Matt, Mirror, White, Titanium, Gold finishing.*
- *IP40 down; IP20 up*
- *Led CoB 2700 K / 3000 K / 4000 K; CRI > 90; MacAdam SDCM < 3*
- *No UV, No IR*
- *Light output from 880 lm up to 3880 lm*
- *Efficacy up to 100 lm/W*
- *Energy Label A*
- *Lifetime L80 / B20 – 50.000 h*
- *Optic lens 15° / 24° / 38° / 55° (interchangeable as accessory)*
- *Cut-off 38°*
- *UGR < 17 / < 19 / < 21*
- *Operating from -20°C up to +45°C*
- *Compliance CE, RoHS*
- *5 years warranty*

Nemo TL Adj / Fix

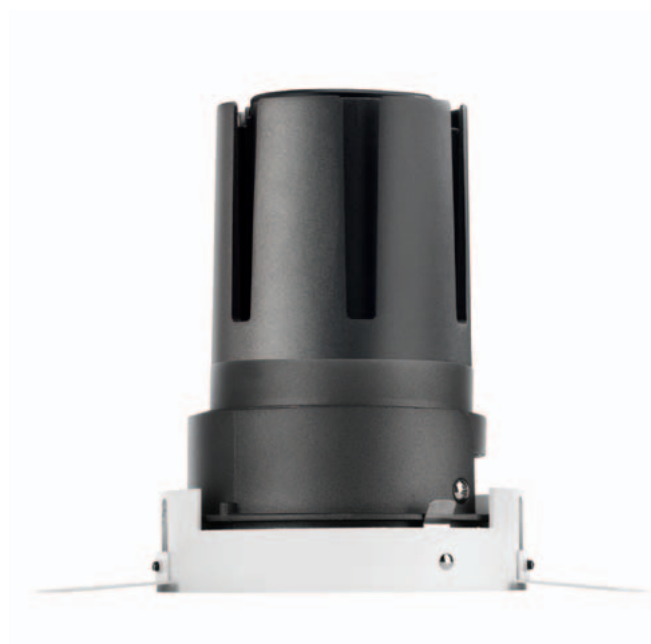
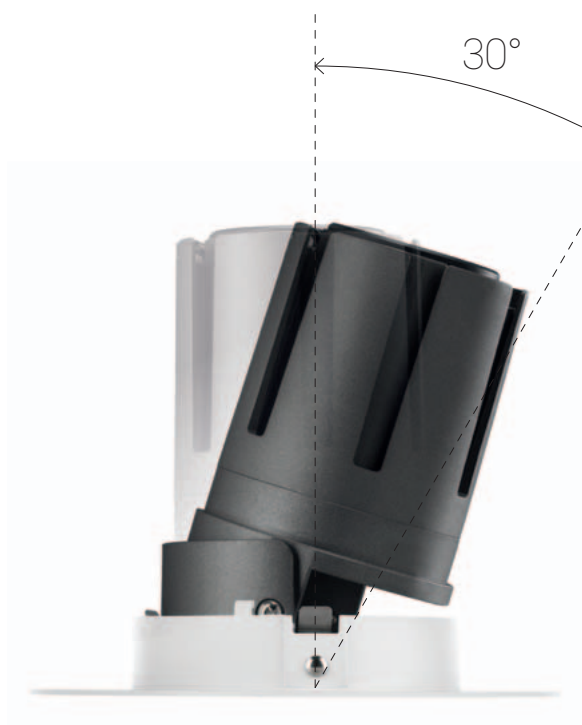

Versioni colore / Color versions

collari decorativi / decorative collars

Satinata
Matt

Speculare
Mirror

Nero titanio
Titanium

Oro lucido
Gold

Bianco opaco
Matt white

anello
trimless
trimless ring

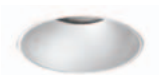

Dimensioni / Dimensions

	Adj	Fix	
<p>10 W 920 lumen</p>	<p>89 25° 355° kg 0,28</p>	<p>89 kg 0,28</p>	<p>*</p> <p>ø71 Ⓛ Ⓜ ø76mm.</p>
<p>15 W 1450 lumen</p>	<p>112 25° 355° kg 0,36</p>	<p>112 kg 0,36</p>	<p>*</p> <p>ø71 Ⓛ Ⓜ ø76 mm.</p>
<p>24 W 2200 lumen</p>	<p>140 25° 355° kg 0,60</p>	<p>140 kg 0,60</p>	<p>*</p> <p>ø95 Ⓛ Ⓜ ø100 mm.</p>
<p>33 W 3100 lumen</p>	<p>169 25° 355° kg 1,05</p>	<p>169 kg 1,05</p>	<p>**</p> <p>116 Ⓛ Ⓜ ø122 mm.</p>
<p>42 W 3800 lumen</p>	<p>184 25° 355° kg 1,49</p>	<p>184 kg 1,49</p>	<p>**</p> <p>142 Ⓛ Ⓜ ø148 mm.</p>

(*) flangia fissa / fixed pre-drilled flange
 (**) flange regolabili in altezza / adjustable height pre-drilled flanges

Nemo TL Adj

anello trimless / *anello trimless*



Ottiche / Optics

vedi pg. 210 / *see pg. 210*

Ricambi / Spare parts

vedi pg. 284 / *see pg. 284*

Versioni dimmerabili / Dimmable versions

con regolazione via cavo
wired dimmable

versioni <i>version</i>	suffisso codice <i>code suffix</i>	nota <i>note</i>	esempio <i>example</i>
Push 1...10 V	DM	per ordinare la versione PUSH / 1...10 V aggiungere DM alla fine del codice <i>to order the PUSH / 1...10 V version add DM to the end of the code</i>	RTL-----DM
DALI	DA	per ordinare la versione DALI aggiungere DA alla fine del codice <i>to order the DALI version add DA to the end of the code</i>	RTL-----DA

con controllo della luce wireless Bluetooth
wireless Bluetooth lighting control

versioni <i>version</i>	suffisso codice <i>code suffix</i>	nota <i>note</i>	esempio <i>example</i>
PAN Digital	PD	per ordinare la versione per smart application PAN Digital aggiungere PD alla fine del codice <i>to order the version for smart application PAN Digital add PD to the end of the code</i>	RTL-----PD
CASAMBI	CA	per ordinare la versione per smart application CASAMBI aggiungere CA alla fine del codice <i>to order the version for smart application CASAMBI add CA to the end of the code</i>	RTL-----CA

versioni Bluetooth per "smart application"; **vedi dettagli alle pagine 8 - 9**
Bluetooth versions for "smart application"; see details to pages 8 - 9

Kit Emergenza / Emergency Kit

autonomia <i>operation time</i>	tempo di accensione <i>switching time</i>	tempo di ricarica <i>recharging time</i>	foro di incasso minimo (*) <i>minimum recessing hole (*)</i>	IP <i>IP</i>	peso <i>weight</i>	codice <i>code</i>
1 ora / 1 hour	0,5 sec.	24 h.	Ø 75 mm.	IP20	0,43 kg	DRV9092
3 ora / 3 hour	0,5 sec.	24 h.	Ø 100mm.	IP20	0,88 kg	DRV9091

(*) per l'installazione in controsoffitto verificare la compatibilità con il foro di incasso; **vedi dettagli a pagina 546**
() for installation in false ceiling check the compatibility with the recessing hole; see details to page 546*



CCT CCT	potenza power	ottica optic	flusso effettivo lumen output	UGR UGR	alluminio satinato matt	speculare mirror	nero titanio titanium	oro lucido gold	bianco opaco matt white
2700 K	10 W	15°	888 lm	≤ 19	RTT20141	RTT20241	RTT20341	RTT20441	RTT20541
		24°	894 lm	≤ 19	RTT20142	RTT20242	RTT20342	RTT20442	RTT20542
		38°	896 lm	≤ 19	RTT20143	RTT20243	RTT20343	RTT20443	RTT20543
		55°	899 lm	≤ 19	RTT20144	RTT20244	RTT20344	RTT20444	RTT20544
	15 W	15°	1359 lm	≤ 17	RTT20145	RTT20245	RTT20345	RTT20445	RTT20545
		24°	1363 lm	≤ 17	RTT20146	RTT20246	RTT20346	RTT20446	RTT20546
		38°	1371 lm	≤ 19	RTT20147	RTT20247	RTT20347	RTT20447	RTT20547
		55°	1383 lm	≤ 19	RTT20148	RTT20248	RTT20348	RTT20448	RTT20548
	24 W	15°	2056 lm	≤ 17	RTT20149	RTT20249	RTT20349	RTT20449	RTT20549
		24°	2058 lm	≤ 17	RTT20150	RTT20250	RTT20350	RTT20450	RTT20550
		38°	2064 lm	≤ 19	RTT20151	RTT20251	RTT20351	RTT20451	RTT20551
		55°	2070 lm	≤ 21	RTT20152	RTT20252	RTT20352	RTT20452	RTT20552
	33 W	15°	2938 lm	≤ 17	RTT20153	RTT20253	RTT20353	RTT20453	RTT20553
		24°	2946 lm	≤ 17	RTT20154	RTT20254	RTT20354	RTT20454	RTT20554
		38°	2954 lm	≤ 19	RTT20155	RTT20255	RTT20355	RTT20455	RTT20555
		55°	2960 lm	≤ 21	RTT20156	RTT20256	RTT20356	RTT20456	RTT20556
	42 W	15°	3678 lm	≤ 17	RTT20157	RTT20257	RTT20357	RTT20457	RTT20557
		24°	3684 lm	≤ 17	RTT20158	RTT20258	RTT20358	RTT20458	RTT20558
		38°	3690 lm	≤ 19	RTT20159	RTT20259	RTT20359	RTT20459	RTT20559
		55°	3696 lm	≤ 21	RTT20160	RTT20260	RTT20360	RTT20460	RTT20560
3000 K	10 W	15°	918 lm	≤ 19	RTT20101	RTT20201	RTT20301	RTT20401	RTT20501
		24°	924 lm	≤ 19	RTT20103	RTT20203	RTT20303	RTT20403	RTT20503
		38°	926 lm	≤ 19	RTT20105	RTT20205	RTT20305	RTT20405	RTT20505
		55°	930 lm	≤ 19	RTT20107	RTT20207	RTT20307	RTT20407	RTT20507
	15 W	15°	1408 lm	≤ 17	RTT20109	RTT20209	RTT20309	RTT20409	RTT20509
		24°	1412 lm	≤ 17	RTT20111	RTT20211	RTT20311	RTT20411	RTT20511
		38°	1420 lm	≤ 19	RTT20113	RTT20213	RTT20313	RTT20413	RTT20513
		55°	1432 lm	≤ 19	RTT20115	RTT20215	RTT20315	RTT20415	RTT20515
	24 W	15°	2150 lm	≤ 17	RTT20117	RTT20217	RTT20317	RTT20417	RTT20517
		24°	2152 lm	≤ 17	RTT20119	RTT20219	RTT20319	RTT20419	RTT20519
		38°	2158 lm	≤ 19	RTT20121	RTT20221	RTT20321	RTT20421	RTT20521
		55°	2164 lm	≤ 21	RTT20123	RTT20223	RTT20323	RTT20423	RTT20523
	33 W	15°	3032 lm	≤ 17	RTT20125	RTT20225	RTT20325	RTT20425	RTT20525
		24°	3040 lm	≤ 17	RTT20127	RTT20227	RTT20327	RTT20427	RTT20527
		38°	3048 lm	≤ 19	RTT20129	RTT20229	RTT20329	RTT20429	RTT20529
		55°	3054 lm	≤ 21	RTT20131	RTT20231	RTT20331	RTT20431	RTT20531
	42 W	15°	3780 lm	≤ 17	RTT20133	RTT20233	RTT20333	RTT20433	RTT20533
		24°	3786 lm	≤ 17	RTT20135	RTT20235	RTT20335	RTT20435	RTT20535
		38°	3792 lm	≤ 19	RTT20137	RTT20237	RTT20337	RTT20437	RTT20537
		55°	3798 lm	≤ 21	RTT20139	RTT20239	RTT20339	RTT20439	RTT20539
4000 K	10 W	15°	956 lm	≤ 19	RTT20102	RTT20202	RTT20302	RTT20402	RTT20502
		24°	958 lm	≤ 19	RTT20104	RTT20204	RTT20304	RTT20404	RTT20504
		38°	968 lm	≤ 19	RTT20106	RTT20206	RTT20306	RTT20406	RTT20506
		55°	974 lm	≤ 19	RTT20108	RTT20208	RTT20308	RTT20408	RTT20508
	15 W	15°	1486 lm	≤ 17	RTT20110	RTT20210	RTT20310	RTT20410	RTT20510
		24°	1494 lm	≤ 17	RTT20112	RTT20212	RTT20312	RTT20412	RTT20512
		38°	1500 lm	≤ 19	RTT20114	RTT20214	RTT20314	RTT20414	RTT20514
		55°	1502 lm	≤ 19	RTT20116	RTT20216	RTT20316	RTT20416	RTT20516
	24 W	15°	2210 lm	≤ 17	RTT20118	RTT20218	RTT20318	RTT20418	RTT20518
		24°	2218 lm	≤ 17	RTT20120	RTT20220	RTT20320	RTT20420	RTT20520
		38°	2226 lm	≤ 19	RTT20122	RTT20222	RTT20322	RTT20422	RTT20522
		55°	2234 lm	≤ 21	RTT20124	RTT20224	RTT20324	RTT20424	RTT20524
	33 W	15°	3116 lm	≤ 17	RTT20126	RTT20226	RTT20326	RTT20426	RTT20526
		24°	3120 lm	≤ 17	RTT20128	RTT20228	RTT20328	RTT20428	RTT20528
		38°	3128 lm	≤ 19	RTT20130	RTT20230	RTT20330	RTT20430	RTT20530
		55°	3134 lm	≤ 21	RTT20132	RTT20232	RTT20332	RTT20432	RTT20532
	42 W	15°	3842 lm	≤ 17	RTT20134	RTT20234	RTT20334	RTT20434	RTT20534
		24°	3858 lm	≤ 17	RTT20136	RTT20236	RTT20336	RTT20436	RTT20536
		38°	3864 lm	≤ 19	RTT20138	RTT20238	RTT20338	RTT20438	RTT20538
		55°	3878 lm	≤ 21	RTT20140	RTT20240	RTT20340	RTT20440	RTT20540

Nemo TL Fix

anello trimless / *anello trimless*



Ottiche / Optics

vedi pg. 210 / *see pg. 210*

Ricambi / Spare parts

vedi pg. 284 / *see pg. 284*

Versioni dimmerabili / Dimmable versions

con regolazione via cavo
wired dimmable

versioni <i>version</i>	suffisso codice <i>code suffix</i>	nota <i>note</i>	esempio <i>example</i>
Push 1...10 V	DM	per ordinare la versione PUSH / 1...10 V aggiungere DM alla fine del codice <i>to order the PUSH / 1...10 V version add DM to the end of the code</i>	RTT-----DM
DALI	DA	per ordinare la versione DALI aggiungere DA alla fine del codice <i>to order the DALI version add DA to the end of the code</i>	RTT-----DA

con controllo della luce wireless Bluetooth
wireless Bluetooth lighting control

versioni <i>version</i>	suffisso codice <i>code suffix</i>	nota <i>note</i>	esempio <i>example</i>
PAN Digital	PD	per ordinare la versione per smart application PAN Digital aggiungere PD alla fine del codice <i>to order the version for smart application PAN Digital add PD to the end of the code</i>	RTT-----PD
CASAMBI	CA	per ordinare la versione per smart application CASAMBI aggiungere CA alla fine del codice <i>to order the version for smart application CASAMBI add CA to the end of the code</i>	RTT-----CA

versioni Bluetooth per "smart application"; **vedi dettagli alle pagine 8 - 9**
Bluetooth versions for "smart application"; see details to pages 8 - 9

Kit Emergenza / Emergency Kit

autonomia <i>operation time</i>	tempo di accensione <i>switching time</i>	tempo di ricarica <i>recharging time</i>	foro di incasso minimo (*) <i>minimum recessing hole (*)</i>	IP <i>IP</i>	peso <i>weight</i>	codice <i>code</i>
1 ora / 1 hour	0,5 sec.	24 h.	Ø 75 mm.	IP20	0,43 kg	DRV9092
3 ora / 3 hour	0,5 sec.	24 h.	Ø 100mm.	IP20	0,88 kg	DRV9091

(*) per l'installazione in controsoffitto verificare la compatibilità con il foro di incasso; **vedi dettagli a pagina 546**
() for installation in false ceiling check the compatibility with the recessing hole; see details to page 546*



CCT CCT	potenza power	ottica optic	flusso effettivo lumen output	UGR UGR	alluminio satinato matt	speculare mirror	nero titanio titanium	oro lucido gold	bianco opaco matt white
2700 K	10 W	15°	888 lm	≤ 19	RTT21141	RTT21241	RTT21341	RTT21441	RTT21541
		24°	894 lm	≤ 19	RTT21142	RTT21242	RTT21342	RTT21442	RTT21542
		38°	896 lm	≤ 19	RTT21143	RTT21243	RTT21343	RTT21443	RTT21543
		55°	899 lm	≤ 19	RTT21144	RTT21244	RTT21344	RTT21444	RTT21544
	15 W	15°	1359 lm	≤ 17	RTT21145	RTT21245	RTT21345	RTT21445	RTT21545
		24°	1363 lm	≤ 17	RTT21146	RTT21246	RTT21346	RTT21446	RTT21546
		38°	1371 lm	≤ 19	RTT21147	RTT21247	RTT21347	RTT21447	RTT21547
		55°	1383 lm	≤ 19	RTT21148	RTT21248	RTT21348	RTT21448	RTT21548
	24 W	15°	2056 lm	≤ 17	RTT21149	RTT21249	RTT21349	RTT21449	RTT21549
		24°	2058 lm	≤ 17	RTT21150	RTT21250	RTT21350	RTT21450	RTT21550
		38°	2064 lm	≤ 19	RTT21151	RTT21251	RTT21351	RTT21451	RTT21551
		55°	2070 lm	≤ 21	RTT21152	RTT21252	RTT21352	RTT21452	RTT21552
	33 W	15°	2938 lm	≤ 17	RTT21153	RTT21253	RTT21353	RTT21453	RTT21553
		24°	2946 lm	≤ 17	RTT21154	RTT21254	RTT21354	RTT21454	RTT21554
		38°	2954 lm	≤ 19	RTT21155	RTT21255	RTT21355	RTT21455	RTT21555
		55°	2960 lm	≤ 21	RTT21156	RTT21256	RTT21356	RTT21456	RTT21556
	42 W	15°	3678 lm	≤ 17	RTT21157	RTT21257	RTT21357	RTT21457	RTT21557
		24°	3684 lm	≤ 17	RTT21158	RTT21258	RTT21358	RTT21458	RTT21558
		38°	3690 lm	≤ 19	RTT21159	RTT21259	RTT21359	RTT21459	RTT21559
		55°	3696 lm	≤ 21	RTT21160	RTT21260	RTT21360	RTT21460	RTT21560
3000 K	10 W	15°	918 lm	≤ 19	RTT21101	RTT21201	RTT21301	RTT21401	RTT21501
		24°	924 lm	≤ 19	RTT21103	RTT21203	RTT21303	RTT21403	RTT21503
		38°	926 lm	≤ 19	RTT21105	RTT21205	RTT21305	RTT21405	RTT21505
		55°	930 lm	≤ 19	RTT21107	RTT21207	RTT21307	RTT21407	RTT21507
	15 W	15°	1408 lm	≤ 17	RTT21109	RTT21209	RTT21309	RTT21409	RTT21509
		24°	1412 lm	≤ 17	RTT21111	RTT21211	RTT21311	RTT21411	RTT21511
		38°	1420 lm	≤ 19	RTT21113	RTT21213	RTT21313	RTT21413	RTT21513
		55°	1432 lm	≤ 19	RTT21115	RTT21215	RTT21315	RTT21415	RTT21515
	24 W	15°	2150 lm	≤ 17	RTT21117	RTT21217	RTT21317	RTT21417	RTT21517
		24°	2152 lm	≤ 17	RTT21119	RTT21219	RTT21319	RTT21419	RTT21519
		38°	2158 lm	≤ 19	RTT21121	RTT21221	RTT21321	RTT21421	RTT21521
		55°	2164 lm	≤ 21	RTT21123	RTT21223	RTT21323	RTT21423	RTT21523
	33 W	15°	3032 lm	≤ 17	RTT21125	RTT21225	RTT21325	RTT21425	RTT21525
		24°	3040 lm	≤ 17	RTT21127	RTT21227	RTT21327	RTT21427	RTT21527
		38°	3048 lm	≤ 19	RTT21129	RTT21229	RTT21329	RTT21429	RTT21529
		55°	3054 lm	≤ 21	RTT21131	RTT21231	RTT21331	RTT21431	RTT21531
	42 W	15°	3780 lm	≤ 17	RTT21133	RTT21233	RTT21333	RTT21433	RTT21533
		24°	3786 lm	≤ 17	RTT21135	RTT21235	RTT21335	RTT21435	RTT21535
		38°	3792 lm	≤ 19	RTT21137	RTT21237	RTT21337	RTT21437	RTT21537
		55°	3798 lm	≤ 21	RTT21139	RTT21239	RTT21339	RTT21439	RTT21539
4000 K	10 W	15°	956 lm	≤ 19	RTT21102	RTT21202	RTT21302	RTT21402	RTT21502
		24°	958 lm	≤ 19	RTT21104	RTT21204	RTT21304	RTT21404	RTT21504
		38°	968 lm	≤ 19	RTT21106	RTT21206	RTT21306	RTT21406	RTT21506
		55°	974 lm	≤ 19	RTT21108	RTT21208	RTT21308	RTT21408	RTT21508
	15 W	15°	1486 lm	≤ 17	RTT21110	RTT21210	RTT21310	RTT21410	RTT21510
		24°	1494 lm	≤ 17	RTT21112	RTT21212	RTT21312	RTT21412	RTT21512
		38°	1500 lm	≤ 19	RTT21114	RTT21214	RTT21314	RTT21414	RTT21514
		55°	1502 lm	≤ 19	RTT21116	RTT21216	RTT21316	RTT21416	RTT21516
	24 W	15°	2210 lm	≤ 17	RTT21118	RTT21218	RTT21318	RTT21418	RTT21518
		24°	2218 lm	≤ 17	RTT21120	RTT21220	RTT21320	RTT21420	RTT21520
		38°	2226 lm	≤ 19	RTT21122	RTT21222	RTT21322	RTT21422	RTT21522
		55°	2234 lm	≤ 21	RTT21124	RTT21224	RTT21324	RTT21424	RTT21524
	33 W	15°	3116 lm	≤ 17	RTT21126	RTT21226	RTT21326	RTT21426	RTT21526
		24°	3120 lm	≤ 17	RTT21128	RTT21228	RTT21328	RTT21428	RTT21528
		38°	3128 lm	≤ 19	RTT21130	RTT21230	RTT21330	RTT21430	RTT21530
		55°	3134 lm	≤ 21	RTT21132	RTT21232	RTT21332	RTT21432	RTT21532
	42 W	15°	3842 lm	≤ 17	RTT21134	RTT21234	RTT21334	RTT21434	RTT21534
		24°	3858 lm	≤ 17	RTT21136	RTT21236	RTT21336	RTT21436	RTT21536
		38°	3864 lm	≤ 19	RTT21138	RTT21238	RTT21338	RTT21438	RTT21538
		55°	3878 lm	≤ 21	RTT21140	RTT21240	RTT21340	RTT21440	RTT21540

Nemo TL Comfort



 IP40 ^{UP TO} 96 lm/W L80 / B20 50.000 h. CRI > 90 SDCM < 3   5 YEARS WARRANTY

Nemo TL è la serie trimless della famiglia Nemo progettata per le installazioni nei controsoffitti in cartongesso senza bordo a vista. I modelli fino a 24W sono dotati di flangia fissa preforata per il fissaggio diretto dell'apparecchio al controsoffitto; I modelli da 33W e 42W sono dotati di flange di fissaggio regolabili in altezza. Nemo TL Comfort è la soluzione ideale per le installazioni che devono garantire il massimo comfort visivo; grazie al suo cut off a 48°, la versione TL Comfort della serie Nemo garantisce il massimo controllo dell'abbagliamento diretto.

I moduli illuminanti sono tutti equipaggiati con led di ultima generazione con CRI > 90 e SDCM < 3. I collari decorativi intercambiabili disponibili in quattro diverse finiture satinare permettono di caratterizzare esteticamente l'impianto anche successivamente alla prima installazione senza alterare la performance illuminotecnica. Il cavetto di sicurezza in dotazione evita la caduta accidentale e il sistema di connessione al driver di tipo "fast plug" permette un'installazione rapida e sicura.

Nemo TL is the trimless series of the Nemo family designed for installations in plasterboard false ceilings with no visible edge. Models up to 24W are equipped with a pre-drilled fixed frame for direct fixing of the luminaire to the false ceiling; The 33W and 42W models are equipped with height-adjustable fixing frame. Nemo TL Comfort is the solution for installations with maximum visual comfort; thanks to its 48 ° cut off, the TL Comfort version of the Nemo series guarantees maximum control of direct glare. The lighting modules are all equipped with the latest generation of LEDs (CRI > 90 and SDCM < 3). The interchangeable decorative collars are available in four different satin finishes and allow you to aesthetically characterize the system even after the first installation without changing the lighting performance. The safety cable supplied prevents accidental drops and the "fast plug" connection system to the driver allows quick and safe installation.

- Alimentazione 220÷240 V / 50÷60 Hz - Classe "II"
- Driver remoto con connessione "fast plug"
- Alimentazioni: On / Off, Dimmerabile Multifunzione (Push / 1...10 V), DALI.
- Kit emergenza 1h / 3h. accessorio remoto
- Installazione "trimless" in controsoffitto. Anello con flangia fissa preforata per versioni fino a 24 W.
- Anello con flange regolabili per versioni da 33W a 42W.
- Installazione in controsoffitti con spessori da 5 mm. a 25 mm per versioni 33W / 42W
- Versioni con controllo digitale "Casambi" o "Pan Digital System"
- Cavetto di sicurezza incluso premontato
- Versioni fisse e orientabili: 350° rotazione orizzontale con stop e 90° inclinazione verticale
- Collare decorativo intercambiabile disponibile in finiture Matt Silver, Matt White, Matt Black, Matt Bronze.
- IP40 vano ottico; IP20 vano incassato
- Led CoB 2700 K / 3000 K / 4000 K con resa cromatica CRI > 90 e MacAdam SDCM < 3
- No UV, No IR
- Emissioni luminose da 890 lm a 3880 lumen
- Efficacia luminosa fino a 100 lm/W
- Efficienza energetica A
- Lifetime L80 / B20 – 50.000 h
- Lenti ottiche da 15° / 24° / 38° / 55° intercambiabili (ricambi)
- Cut-off 48°
- UGR < 17 / < 19 / < 21
- Classe "II"
- Temperatura ambiente di esercizio da -20°C a +45°C
- Certificazione CE, RoHS
- 5 anni di garanzia

- *Feeding 220÷240 V / 50÷60 Hz - Class "II"*
- *Remote driver with "fast plug" connectors*
- *Switching: On / Off, Multifunction Dimmable (Push / 1...10 V), DALI.*
- *Emergency Kit 1h / 3h as remote accessory.*
- *Digital Control Versions "Casambi" or "Pan Digital System"*
- *Trimless mounting for plaster false ceiling. Ring with fixed pre-drilled flange for model up to 24 W.*
- *Ring with adjustable height pre-drilled flange for model from 33W to 42W.*
- *Mounting on false ceiling depth from 5 mm. up to 25 mm for model from 33W to 42W.*
- *Safe cable included pre-mounted*
- *Fixed and Adjustable versions: 350° horizontal rotation with stop, 90° vertical rotation*
- *Decorative collars interchangeable and available in Matt Silver, Matt White, Matt Black, Matt Bronze finishing.*
- *IP40 down; IP20 up*
- *Led CoB 2700 K / 3000 K / 4000 K; CRI > 90; MacAdam SDCM < 3*
- *No UV, No IR*
- *Light output from 880 lm up to 3880 lm*
- *Efficacy up to 100 lm/W*
- *Energy Label A*
- *Lifetime L80 / B20 – 50.000 h*
- *Optic lens 15° / 24° / 38° / 55° (interchangeable as accessory)*
- *Cut-off 48°*
- *UGR < 17 / < 19 / < 21*
- *Operating from -20°C up to +45°C*
- *Compliance CE, RoHS*
- *5 years warranty*

Nemo TL Comfort



Versioni colore / *Color versions*

collari decorativi / *decorative collars*

Satinata
Matt

Bianco opaco
Matt white

Nero opaco
Matt black

Bronzo opaco
Matt bronze

anello
trimless
trimless ring



Dimensioni / Dimensions

Comfort

<p>10 W 920 lumen</p>	 <p>107 355°</p>	 <p>ø71</p>
<p>15 W 1450 lumen</p>	 <p>130 355°</p>	 <p>ø71</p>
<p>24 W 2200 lumen</p>	 <p>165 355°</p>	 <p>ø95</p>
<p>33 W 3100 lumen</p>	 <p>200 355°</p>	 <p>ø121</p>
<p>42 W 3800 lumen</p>	 <p>229 355°</p>	 <p>ø147</p>

kg 0,26

Ⓛ Ⓜ ø75 mm.

kg 0,33

Ⓛ Ⓜ ø75 mm.

kg 0,77

Ⓛ Ⓜ ø100 mm.

kg 0,99

Ⓛ Ⓜ ø125 mm.

kg 1,27

Ⓛ Ⓜ ø150 mm.

Nemo TL Comfort

anello trimless / *anello trimless*



Ottiche / Optics

vedi pg. 210 / *see pg. 210*

Ricambi / Spare parts

vedi pg. 284 / *see pg. 284*

Versioni dimmerabili / Dimmable versions

con regolazione via cavo
wired dimmable

versioni <i>version</i>	suffisso codice <i>code suffix</i>	nota <i>note</i>	esempio <i>example</i>
Push 1...10 V	DM	per ordinare la versione PUSH / 1...10 V aggiungere DM alla fine del codice <i>to order the PUSH / 1...10 V version add DM to the end of the code</i>	RTT-----DM
DALI	DA	per ordinare la versione DALI aggiungere DA alla fine del codice <i>to order the DALI version add DA to the end of the code</i>	RTT-----DA

con controllo della luce wireless Bluetooth
wireless Bluetooth lighting control

versioni <i>version</i>	suffisso codice <i>code suffix</i>	nota <i>note</i>	esempio <i>example</i>
PAN Digital	PD	per ordinare la versione per smart application PAN Digital aggiungere PD alla fine del codice <i>to order the version for smart application PAN Digital add PD to the end of the code</i>	RTT-----PD
CASAMBI	CA	per ordinare la versione per smart application CASAMBI aggiungere CA alla fine del codice <i>to order the version for smart application CASAMBI add CA to the end of the code</i>	RTT-----CA

versioni Bluetooth per "smart application"; **vedi dettagli alle pagine 8 - 9**
Bluetooth versions for "smart application"; see details to pages 8 - 9

Kit Emergenza / Emergency Kit

autonomia <i>operation time</i>	tempo di accensione <i>switching time</i>	tempo di ricarica <i>recharging time</i>	foro di incasso minimo (*) <i>minimum recessing hole (*)</i>	IP <i>IP</i>	peso <i>weight</i>	codice <i>code</i>
1 ora / 1 hour	0,5 sec.	24 h.	Ø 75 mm.	IP20	0,43 kg	DRV9092
3 ora / 3 hour	0,5 sec.	24 h.	Ø 100mm.	IP20	0,88 kg	DRV9091

(*) per l'installazione in controsoffitto verificare la compatibilità con il foro di incasso; **vedi dettagli a pagina 546**
() for installation in false ceiling check the compatibility with the recessing hole; see details to page 546*

Nemo TL Comfort

anello trimless / anello trimless



CCT CCT	potenza power	ottica optic	flusso effettivo lumen output	UGR UGR	alluminio satinato matt silver	bianco opaco matt white	nero opaco matt black	bronzo opaco matt bronze
2700 K	10 W	15°	876 lm	≤ 17	RTT22141	RTT22241	RTT22341	RTT22441
		24°	882 lm	≤ 17	RTT22142	RTT22242	RTT22342	RTT22442
		38°	879 lm	≤ 17	RTT22143	RTT22243	RTT22343	RTT22443
		55°	886 lm	≤ 17	RTT22144	RTT22244	RTT22344	RTT22444
	15 W	15°	1345 lm	≤ 17	RTT22145	RTT22245	RTT22345	RTT22445
		24°	1349 lm	≤ 17	RTT22146	RTT22246	RTT22346	RTT22446
		38°	1353 lm	≤ 17	RTT22147	RTT22247	RTT22347	RTT22447
		55°	1369 lm	≤ 19	RTT22148	RTT22248	RTT22348	RTT22448
	24 W	15°	2054 lm	≤ 17	RTT22149	RTT22249	RTT22349	RTT22449
		24°	2062 lm	≤ 17	RTT22150	RTT22250	RTT22350	RTT22450
		38°	2076 lm	≤ 17	RTT22151	RTT22251	RTT22351	RTT22451
		55°	2090 lm	≤ 19	RTT22152	RTT22252	RTT22352	RTT22452
	33 W	15°	2926 lm	≤ 17	RTT22153	RTT22253	RTT22353	RTT22453
		24°	2932 lm	≤ 17	RTT22154	RTT22254	RTT22354	RTT22454
		38°	2938 lm	≤ 17	RTT22155	RTT22255	RTT22355	RTT22455
		55°	2946 lm	≤ 21	RTT22156	RTT22256	RTT22356	RTT22456
	42 W	15°	3666 lm	≤ 17	RTT22157	RTT22257	RTT22357	RTT22457
		24°	3670 lm	≤ 17	RTT22158	RTT22258	RTT22358	RTT22458
		38°	3678 lm	≤ 17	RTT22159	RTT22259	RTT22359	RTT22459
		55°	3684 lm	≤ 21	RTT22160	RTT22260	RTT22360	RTT22460
3000 K	10 W	15°	906 lm	≤ 17	RTT22101	RTT22201	RTT22301	RTT22401
		24°	912 lm	≤ 17	RTT22103	RTT22203	RTT22303	RTT22403
		38°	910 lm	≤ 17	RTT22105	RTT22205	RTT22305	RTT22405
		55°	916 lm	≤ 17	RTT22107	RTT22207	RTT22307	RTT22407
	15 W	15°	1394 lm	≤ 17	RTT22109	RTT22209	RTT22309	RTT22409
		24°	1398 lm	≤ 17	RTT22111	RTT22211	RTT22311	RTT22411
		38°	1402 lm	≤ 17	RTT22113	RTT22213	RTT22313	RTT22413
		55°	1418 lm	≤ 19	RTT22115	RTT22215	RTT22315	RTT22415
	24 W	15°	2148 lm	≤ 17	RTT22117	RTT22217	RTT22317	RTT22417
		24°	2156 lm	≤ 17	RTT22119	RTT22219	RTT22319	RTT22419
		38°	2170 lm	≤ 17	RTT22121	RTT22221	RTT22321	RTT22421
		55°	2184 lm	≤ 19	RTT22123	RTT22223	RTT22323	RTT22423
	33 W	15°	3020 lm	≤ 17	RTT22125	RTT22225	RTT22325	RTT22425
		24°	3028 lm	≤ 17	RTT22127	RTT22227	RTT22327	RTT22427
		38°	3032 lm	≤ 17	RTT22129	RTT22229	RTT22329	RTT22429
		55°	3040 lm	≤ 21	RTT22131	RTT22231	RTT22331	RTT22431
	42 W	15°	3768 lm	≤ 17	RTT22133	RTT22233	RTT22333	RTT22433
		24°	3772 lm	≤ 17	RTT22135	RTT22235	RTT22335	RTT22435
		38°	3780 lm	≤ 17	RTT22137	RTT22237	RTT22337	RTT22437
		55°	3786 lm	≤ 21	RTT22139	RTT22239	RTT22339	RTT22439
4000 K	10 W	15°	948 lm	≤ 17	RTT22102	RTT22202	RTT22302	RTT22402
		24°	950 lm	≤ 17	RTT22104	RTT22204	RTT22304	RTT22404
		38°	956 lm	≤ 17	RTT22106	RTT22206	RTT22306	RTT22406
		55°	968 lm	≤ 17	RTT22108	RTT22208	RTT22308	RTT22408
	15 W	15°	1430 lm	≤ 17	RTT22110	RTT22210	RTT22310	RTT22410
		24°	1436 lm	≤ 17	RTT22112	RTT22212	RTT22312	RTT22412
		38°	1440 lm	≤ 17	RTT22114	RTT22214	RTT22314	RTT22414
		55°	1452 lm	≤ 19	RTT22116	RTT22216	RTT22316	RTT22416
	24 W	15°	2180 lm	≤ 17	RTT22118	RTT22218	RTT22318	RTT22418
		24°	2192 lm	≤ 17	RTT22120	RTT22220	RTT22320	RTT22420
		38°	2212 lm	≤ 17	RTT22122	RTT22222	RTT22322	RTT22422
		55°	2224 lm	≤ 19	RTT22124	RTT22224	RTT22324	RTT22424
	33 W	15°	3072 lm	≤ 17	RTT22126	RTT22226	RTT22326	RTT22426
		24°	3082 lm	≤ 17	RTT22128	RTT22228	RTT22328	RTT22428
		38°	3094 lm	≤ 17	RTT22130	RTT22230	RTT22330	RTT22430
		55°	3098 lm	≤ 21	RTT22132	RTT22232	RTT22332	RTT22432
	42 W	15°	3806 lm	≤ 17	RTT22134	RTT22234	RTT22334	RTT22434
		24°	3824 lm	≤ 17	RTT22136	RTT22236	RTT22336	RTT22436
		38°	3834 lm	≤ 17	RTT22138	RTT22238	RTT22338	RTT22438
		55°	3844 lm	≤ 21	RTT22140	RTT22240	RTT22340	RTT22440

Nemo IP54



□ IP54 ^{UP TO} 92 lm/W L80 / B20 50.000 h. CRI > 90 SDCM < 3   5 YEARS WARRANTY

Nemo IP54 offre una completa gamma di ottiche e temperature di colore ed è la soluzione ideale per quelle installazioni dove è necessario proteggere il vano ottico e la sorgente led dalla polvere e dagli spruzzi d'acqua. Equipaggiato di serie con un vetro prismatico, diffonde la luce in modo ottimale mantenendo inalterate tutte le caratteristiche cromatiche date dalla sorgente led selezionata fra le prime marche.

Nemo IP54 offers a complete range of optics and color temperatures and is the ideal solution for installations where it is necessary to protect the optical compartment and the LED source from dust and splashes of water. Equipped as standard with a prismatic glass, it diffuses the light optimally while maintaining all the chromatic characteristics given by the LED source (selected among the first brands).



















- Alimentazione 220÷240 V / 50÷60 Hz - Classe "II"
- Driver remoto con connessione "fast plug"
- Alimentazioni: On / Off, Dimmerabile Multifunzione (Push / 1...10 V), DALI.
- Kit emergenza 1h / 3h accessorio remoto.
- Versioni con controllo digitale "Casambi" o "Pan Digital System"
- Installazione in controsoffitti con spessori da 5 mm. a 25 mm.
- Cavetto di sicurezza incluso premontato
- Versioni fisse e orientabili: 350° rotazione orizzontale con stop e 90° inclinazione verticale
- Colore anello strutturale: bianco opaco.
- Vetro di protezione microprismatico.
- IP54 vano ottico; IP20 vano incassato
- Led CoB 2700 K / 3000 K / 4000 K con resa cromatica CRI > 90 e MacAdam SDCM < 3
- No UV, No IR
- Emissioni luminose da 820 lm a 1380 lumen
- Efficacia luminosa fino a 92 lm/W
- Efficienza energetica A
- Lifetime L80 / B20 – 50.000 h
- Lenti ottiche da 15° / 24° / 38° intercambiabili (ricambi)
- UGR < 17 / < 19
- Classe "II"
- Temperatura ambiente di esercizio da -20°C a +45°C
- Certificazione CE, RoHS
- 5 anni di garanzia

- *Feeding 220÷240 V / 50÷60 Hz - Class "II"*
- *Remote driver with "fast plug" connectors*
- *Switching: On / Off, Multifunction Dimmable (Push / 1... 10 V), DALI.*
- *Emergency Kit 1h / 3h as remote accessory.*
- *Digital Control Versions "Casambi" or "Pan Digital System"*
- *Mounting on false ceiling depth from 5 mm. up to 25 mm.*
- *Safe cable included pre-mounted*
- *Fixed and Adjustable versions: 350° horizontal rotation with stop, 90° vertical rotation*
- *Ring colour: matt white.*
- *Microprismatic safety glass*
- *IP54 down; IP20 up*
- *Led CoB 2700 K / 3000 K / 4000 K; CRI > 90; MacAdam SDCM < 3*
- *No UV, No IR*
- *Light output from 820 lm up to 1380 lm*
- *Efficacy up to 92 lm/W*
- *Energy Label A*
- *Lifetime L80 / B20 – 50.000 h*
- *Optic lens 15° / 24° / 38° (interchangable as accessory)*
- *UGR < 17 / < 19*
- *Operating from -20°C up to +45°C*
- *Compliance CE, RoHS*
- *5 years warranty*

Nemo IP54

Dimensioni / Dimensions

Rounded		Squared	
10 W	15 W	10 W	15 W
			
85	108	85	108
			
ø88	ø88	88x88	88x88
 0,34	 0,55	 0,34	 0,55
 ø75 mm.	 ø75 mm.	 ø75x75 mm.	 ø75x75 mm.

Versioni dimmerabili / Dimmable versions

con regolazione via cavo
wired dimmable

versioni version	suffisso codice code suffix	nota note	esempio example
Push 1...10 V	DM	per ordinare la versione PUSH / 1...10 V aggiungere DM alla fine del codice to order the PUSH / 1...10 V version add DM to the end of the code	RTL----DM
DALI	DA	per ordinare la versione DALI aggiungere DA alla fine del codice to order the DALI version add DA to the end of the code	RTL----DA

con controllo della luce wireless Bluetooth
wireless Bluetooth lighting control

versioni version	suffisso codice code suffix	nota note	esempio example
PAN Digital	PD	per ordinare la versione per smart application PAN Digital aggiungere PD alla fine del codice to order the version for smart application PAN Digital add PD to the end of the code	RTL----PD
CASAMBI	CA	per ordinare la versione per smart application CASAMBI aggiungere CA alla fine del codice to order the version for smart application CASAMBI add CA to the end of the code	RTL----CA

versioni Bluetooth per "smart application"; vedi dettagli alle pagine 8 - 9
Bluetooth versions for "smart application"; see details to pages 8 - 9

Kit Emergenza / Emergency Kit

autonomia operation time	tempo di accensione switching time	tempo di ricarica recharging time	foro di incasso minimo (*) minimum recessing hole (*)	IP IP	peso weight	codice code
1 ora / 1 hour	0,5 sec.	24 h.	Ø 75 mm.	IP20	0,43 kg	DRV9092
3 ora / 3 hour	0,5 sec.	24 h.	Ø 100mm.	IP20	0,88 kg	DRV9091

(*) per l'installazione in controsoffitto verificare la compatibilità con il foro di incasso; vedi dettagli a pagina 546
(* for installation in false ceiling check the compatibility with the recessing hole; see details to page 546)

Nemo IP54

CRI > 90

Tondo - *Rounded*

versione version	potenza power	ottica optic	codice code	CCT CCT	CRI CRI	MacAdam SDCM	flusso apparecchio light output	UGR UGR	colore colour
On / Off	10 W	15°	RTL16107	2700 K	> 90	< 3	817 lm	≤ 19	bianco / white
			RTL16108	3000 K	> 90	< 3	845 lm	≤ 19	bianco / white
			RTL16109	4000 K	> 90	< 3	880 lm	≤ 19	bianco / white
		24°	RTL16110	2700 K	> 90	< 3	823 lm	≤ 19	bianco / white
			RTL16111	3000 K	> 90	< 3	851 lm	≤ 19	bianco / white
			RTL16112	4000 K	> 90	< 3	882 lm	≤ 19	bianco / white
		38°	RTL16113	2700 K	> 90	< 3	825 lm	≤ 19	bianco / white
			RTL16114	3000 K	> 90	< 3	853 lm	≤ 19	bianco / white
			RTL16115	4000 K	> 90	< 3	892 lm	≤ 19	bianco / white
	15 W	15°	RTL16116	2700 K	> 90	< 3	1251 lm	≤ 17	bianco / white
			RTL16117	3000 K	> 90	< 3	1296 lm	≤ 17	bianco / white
			RTL16118	4000 K	> 90	< 3	1368 lm	≤ 17	bianco / white
		24°	RTL16119	2700 K	> 90	< 3	1255 lm	≤ 17	bianco / white
			RTL16120	3000 K	> 90	< 3	1300 lm	≤ 17	bianco / white
			RTL16121	4000 K	> 90	< 3	1376 lm	≤ 17	bianco / white
		38°	RTL16122	2700 K	> 90	< 3	1263 lm	≤ 19	bianco / white
			RTL16123	3000 K	> 90	< 3	1308 lm	≤ 19	bianco / white
			RTL16124	4000 K	> 90	< 3	1382 lm	≤ 19	bianco / white

Quadrato - *Squared*

versione version	potenza power	ottica optic	codice code	temp. di colore light temperature	CRI CRI	MacAdam SDCM	flusso apparecchio light output	UGR UGR	colore colour
On / Off	10 W	15°	RTL16207	2700 K	> 90	< 3	817 lm	≤ 19	bianco / white
			RTL16208	3000 K	> 90	< 3	845 lm	≤ 19	bianco / white
			RTL16209	4000 K	> 90	< 3	880 lm	≤ 19	bianco / white
		24°	RTL16210	2700 K	> 90	< 3	823 lm	≤ 19	bianco / white
			RTL16211	3000 K	> 90	< 3	851 lm	≤ 19	bianco / white
			RTL16212	4000 K	> 90	< 3	882 lm	≤ 19	bianco / white
		38°	RTL16213	2700 K	> 90	< 3	825 lm	≤ 19	bianco / white
			RTL16214	3000 K	> 90	< 3	853 lm	≤ 19	bianco / white
			RTL16215	4000 K	> 90	< 3	892 lm	≤ 19	bianco / white
	15 W	15°	RTL16216	2700 K	> 90	< 3	1251 lm	≤ 17	bianco / white
			RTL16217	3000 K	> 90	< 3	1296 lm	≤ 17	bianco / white
			RTL16218	4000 K	> 90	< 3	1368 lm	≤ 17	bianco / white
		24°	RTL16219	2700 K	> 90	< 3	1255 lm	≤ 17	bianco / white
			RTL16220	3000 K	> 90	< 3	1300 lm	≤ 17	bianco / white
			RTL16221	4000 K	> 90	< 3	1376 lm	≤ 17	bianco / white
		38°	RTL16222	2700 K	> 90	< 3	1263 lm	≤ 19	bianco / white
			RTL16223	3000 K	> 90	< 3	1308 lm	≤ 19	bianco / white
			RTL16224	4000 K	> 90	< 3	1382 lm	≤ 19	bianco / white

Widot





Widot



□ IP40 UP TO 89 lm / W L80 / B20 50.000 h. CRI > 90 SDCM < 3   5 YEARS WARRANTY

Widot è un apparecchio da incasso caratterizzato dal suo anello di battuta che, completamente bianco e curvato verso l'interno, assicura continuità con il controsoffitto senza segni o differenze di finiture. Widot è quindi particolarmente indicato per tutti quegli impianti dove si desidera mimetizzare l'apparecchio in un controsoffitto bianco senza dover ricorrere alla rasatura a gesso. Facile e veloce da installare grazie al sistema di aggancio rapido e al connettore "fast plug" del driver, Widot è la giusta soluzione per impianti che necessitano di semplicità e rapidità nella fase di installazione senza rinunciare alla pulizia estetica e formale delle parti visibili. I led CoB sono selezionati fra marche "prime brand" e le quattro ottiche disponibili permettono di realizzare diversi effetti di luce di accento per tutte le principali esigenze illuminotecniche. La versione asimmetrica completa la gamma permettendo l'illuminazione delle pareti con effetti di "accent washing".

Widot is therefore particularly suitable for all those lighting systems where the fixtures must be installed in a white false ceiling without the plaster finishing; it is a recessed product characterized by its rounded housing that, completely white and curved inwards, ensures continuity with false ceiling without signs or differences in finishes. Quick and easy to install thanks to the fast coupling system and to the "fast plug" connector of the driver, Widot is the right solution for systems that need quick installation without renouncing the aesthetic and formal cleaning of visible parts. CoB leds are selected among prime brands and the four available optics enable the realization of different accent lighting effects for all the main lighting requirements. The asymmetrical version completes the range, allows the lighting of the walls with "accent washing" effects. The asymmetrical version completes the range allowing the lighting of the walls with "accent washing" effects.



- Alimentazione 220÷240 V / 50÷60 Hz - Classe "II"
- Driver remoto con connessione "fast plug"
- Alimentazioni: On / Off, Dimmerabile Multifunzione (Push / 1...10 V), DALI.
- Kit emergenza 1h / 3h. accessorio remoto.
- Versioni con controllo digitale "Casambi" o "Pan Digital System"
- Versioni da 10 W e 15 W installabili in controsoffitti con spessori da 2 mm. a 23 mm.;
- Versioni da 24 W, 33 W e 42 W installabili in controsoffitti con spessori da 2 mm. a 30 mm.
- Colore anello strutturale: bianco opaco.
- IP40 vano ottico; IP20 vano incassato
- Led CoB 2700 K / 3000 K / 4000 K con resa cromatica CRI > 90 e MacAdam SDCM < 3
- No UV, No IR
- Emissioni luminose da 860 lm a 3880 lumen
- Efficacia luminosa fino a 100 lm/W
- Efficienza energetica A
- Lifetime L80 / B20 – 50.000 h
- Lenti ottiche da 15° / 24° / 38° / 55° intercambiabili (ricambi). Emissioni simmetriche e asimmetriche.
- Cut-off 37°
- UGR < 17 / < 19 / < 21
- Temperatura ambiente di esercizio da -20°C a +45°C
- Certificazione CE, RoHS
- 5 anni di garanzia

- *Feeding 220÷240 V / 50÷60 Hz - Class "II"*
- *Remote driver with "fast plug" connectors*
- *Switching: On / Off, Multifunction Dimmable (Push / 1...10 V), DALI.*
- *Emergency Kit 1h / 3h as remote accessory.*
- *Digital Control Versions "Casambi" or "Pan Digital System"*
- *Versions 10 W and 15 W suitable for false ceiling depth from 5 mm. up to 23 mm.*
- *Versions 24 W, 33 W and 42 W suitable for false ceiling depth from 5 mm. up to 30 mm.*
- *Ring colour: matt white.*
- *IP40 down; IP20 up*
- *Led CoB 2700 K / 3000 K / 4000 K; CRI > 90; MacAdam SDCM < 3*
- *No UV, No IR*
- *Light output from 860 lm up to 3880 lm*
- *Efficacy up to 100 lm/W*
- *Energy Label A*
- *Lifetime L80 / B20 – 50.000 h*
- *Optic lens 15° / 24° / 38° / 55° (interchangeable as accessory). Symmetric and Asymmetric both versions available.*
- *Cut-off 37°*
- *UGR < 17 / < 19 / < 21*
- *Operating from -20°C up to +45°C*
- *Compliance CE, RoHS*
- *5 years warranty*



Widot

Dimensioni / Dimensions

Widot

Widot AS

10W 920 lumen	 90	 ø88	 80	 ø88
	 ø75 mm.  0,32		 ø75 mm.  0,30	
15W 1450 lumen	 113	 ø88	 101	 ø88
	 ø75 mm.  0,39		 ø75 mm.  0,36	
24W 2200 lumen	 146	 ø110		
	 ø100 mm.  0,66			
33W 3100 lumen	 178	 ø138		
	 ø125 mm.  0,83			
42W 3800 lumen	 202	 ø166		
	 ø150 mm.  1,14			

Widot



Ottiche / Optics

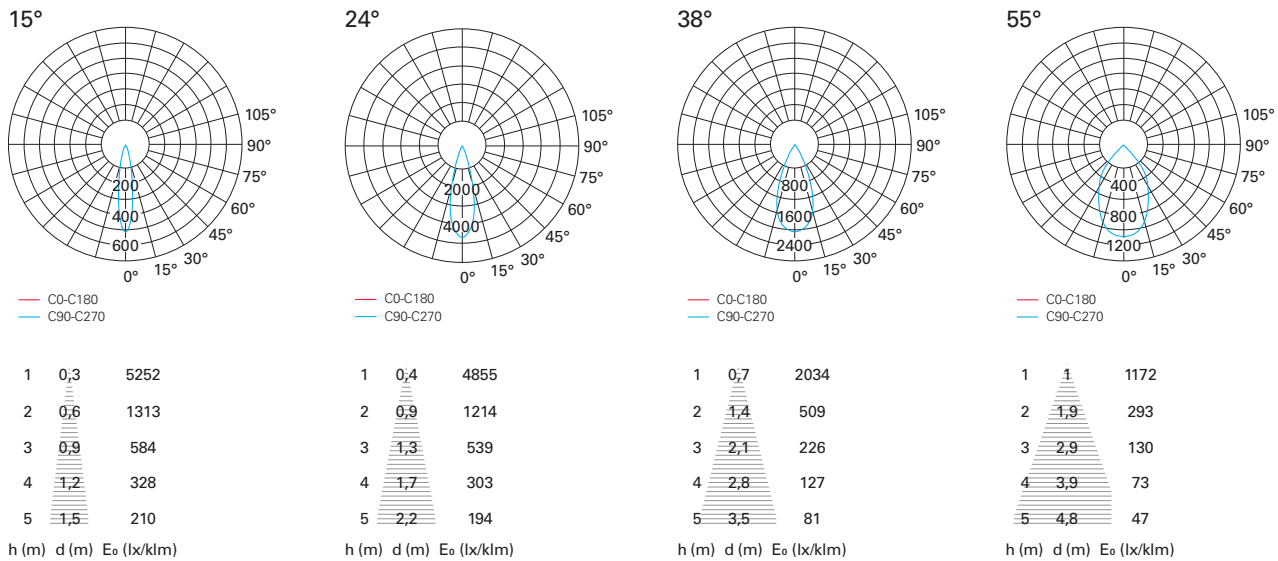

Versioni dimmerabili / Dimmable versions

con regolazione via cavo
wired dimmable

versioni version	suffisso codice code suffix	nota note	esempio example
Push 1...10 V	DM	per ordinare la versione PUSH / 1...10 V aggiungere DM alla fine del codice to order the PUSH / 1...10 V version add DM to the end of the code	RTL-----DM
DALI	DA	per ordinare la versione DALI aggiungere DA alla fine del codice to order the DALI version add DA to the end of the code	RTL-----DA

con controllo della luce wireless Bluetooth
wireless Bluetooth lighting control

versioni version	suffisso codice code suffix	nota note	esempio example
PAN Digital	PD	per ordinare la versione per smart application PAN Digital aggiungere PD alla fine del codice to order the version for smart application PAN Digital add PD to the end of the code	RTL-----PD
CASAMBI	CA	per ordinare la versione per smart application CASAMBI aggiungere CA alla fine del codice to order the version for smart application CASAMBI add CA to the end of the code	RTL-----CA

versioni Bluetooth per "smart application"; vedi dettagli alle pagine 8 - 9
Bluetooth versions for "smart application"; see details to pages 8 - 9

Kit Emergenza / Emergency Kit

autonomia operation time	tempo di accensione switching time	tempo di ricarica recharging time	foro di incasso minimo (*) minimum recessing hole (*)	IP IP	peso weight	codice code
1 ora / 1 hour	0,5 sec.	24 h.	Ø 75 mm.	IP20	0,43 kg	DRV9092
3 ora / 3 hour	0,5 sec.	24 h.	Ø 100mm.	IP20	0,88 kg	DRV9091

(*) per l'installazione in controsoffitto verificare la compatibilità con il foro di incasso; vedi dettagli a pagina 546
(* for installation in false ceiling check the compatibility with the recessing hole; see details to page 546)

CCT CCT	potenza power	ottica optic	codice code	CRI CRI	MacAdam SDCM	flusso apparecchio lumen output	UGR UGR	colore colour
2700 K	10 W	15°	RTL24541	> 90	< 3	854 lm	≤ 17	bianco / white
		24°	RTL24542	> 90	< 3	862 lm	≤ 17	bianco / white
		38°	RTL24543	> 90	< 3	868 lm	≤ 21	bianco / white
		55°	RTL24544	> 90	< 3	876 lm	≤ 21	bianco / white
	15 W	15°	RTL24545	> 90	< 3	1323 lm	≤ 17	bianco / white
		24°	RTL24546	> 90	< 3	1327 lm	≤ 17	bianco / white
		38°	RTL24547	> 90	< 3	1337 lm	≤ 21	bianco / white
		55°	RTL24548	> 90	< 3	1349 lm	≤ 21	bianco / white
	24 W	15°	RTL24549	> 90	< 3	2040 lm	≤ 19	bianco / white
		24°	RTL24550	> 90	< 3	2044 lm	≤ 19	bianco / white
		38°	RTL24551	> 90	< 3	2054 lm	≤ 21	bianco / white
		55°	RTL24552	> 90	< 3	2062 lm	≤ 21	bianco / white
	33 W	15°	RTL24553	> 90	< 3	2910 lm	≤ 19	bianco / white
		24°	RTL24554	> 90	< 3	2918 lm	≤ 19	bianco / white
		38°	RTL24555	> 90	< 3	2926 lm	≤ 21	bianco / white
		55°	RTL24556	> 90	< 3	2934 lm	≤ 21	bianco / white
	42 W	15°	RTL24557	> 90	< 3	3644 lm	≤ 19	bianco / white
		24°	RTL24558	> 90	< 3	3648 lm	≤ 19	bianco / white
		38°	RTL24559	> 90	< 3	3660 lm	≤ 21	bianco / white
		55°	RTL24560	> 90	< 3	3664 lm	≤ 21	bianco / white
3000 K	10 W	15°	RTL24501	> 90	< 3	884 lm	≤ 17	bianco / white
		24°	RTL24503	> 90	< 3	892 lm	≤ 17	bianco / white
		38°	RTL24505	> 90	< 3	898 lm	≤ 21	bianco / white
		55°	RTL24507	> 90	< 3	906 lm	≤ 21	bianco / white
	15 W	15°	RTL24509	> 90	< 3	1372 lm	≤ 17	bianco / white
		24°	RTL24511	> 90	< 3	1376 lm	≤ 17	bianco / white
		38°	RTL24513	> 90	< 3	1386 lm	≤ 21	bianco / white
		55°	RTL24515	> 90	< 3	1398 lm	≤ 21	bianco / white
	24 W	15°	RTL24517	> 90	< 3	2134 lm	≤ 19	bianco / white
		24°	RTL24519	> 90	< 3	2138 lm	≤ 19	bianco / white
		38°	RTL24521	> 90	< 3	2148 lm	≤ 21	bianco / white
		55°	RTL24523	> 90	< 3	2156 lm	≤ 21	bianco / white
	33 W	15°	RTL24525	> 90	< 3	3004 lm	≤ 19	bianco / white
		24°	RTL24527	> 90	< 3	3012 lm	≤ 19	bianco / white
		38°	RTL24529	> 90	< 3	3024 lm	≤ 21	bianco / white
		55°	RTL24531	> 90	< 3	3028 lm	≤ 21	bianco / white
	42 W	15°	RTL24533	> 90	< 3	3746 lm	≤ 19	bianco / white
		24°	RTL24535	> 90	< 3	3750 lm	≤ 19	bianco / white
		38°	RTL24537	> 90	< 3	3762 lm	≤ 21	bianco / white
		55°	RTL24539	> 90	< 3	3766 lm	≤ 21	bianco / white
4000 K	10 W	15°	RTL24502	> 90	< 3	950 lm	≤ 17	bianco / white
		24°	RTL24504	> 90	< 3	948 lm	≤ 17	bianco / white
		38°	RTL24506	> 90	< 3	954 lm	≤ 21	bianco / white
		55°	RTL24508	> 90	< 3	962 lm	≤ 21	bianco / white
	15 W	15°	RTL24510	> 90	< 3	1450 lm	≤ 17	bianco / white
		24°	RTL24512	> 90	< 3	1454 lm	≤ 17	bianco / white
		38°	RTL24514	> 90	< 3	1464 lm	≤ 21	bianco / white
		55°	RTL24516	> 90	< 3	1476 lm	≤ 21	bianco / white
	24 W	15°	RTL24518	> 90	< 3	2180 lm	≤ 19	bianco / white
		24°	RTL24520	> 90	< 3	2184 lm	≤ 19	bianco / white
		38°	RTL24522	> 90	< 3	2194 lm	≤ 21	bianco / white
		55°	RTL24524	> 90	< 3	2202 lm	≤ 21	bianco / white
	33 W	15°	RTL24526	> 90	< 3	3090 lm	≤ 19	bianco / white
		24°	RTL24528	> 90	< 3	3098 lm	≤ 19	bianco / white
		38°	RTL24530	> 90	< 3	3110 lm	≤ 21	bianco / white
		55°	RTL24532	> 90	< 3	3118 lm	≤ 21	bianco / white
	42 W	15°	RTL24534	> 90	< 3	3784 lm	≤ 19	bianco / white
		24°	RTL24536	> 90	< 3	3788 lm	≤ 19	bianco / white
		38°	RTL24538	> 90	< 3	3800 lm	≤ 21	bianco / white
		55°	RTL24540	> 90	< 3	3804 lm	≤ 21	bianco / white

Widot AS



Ottiche / Optics

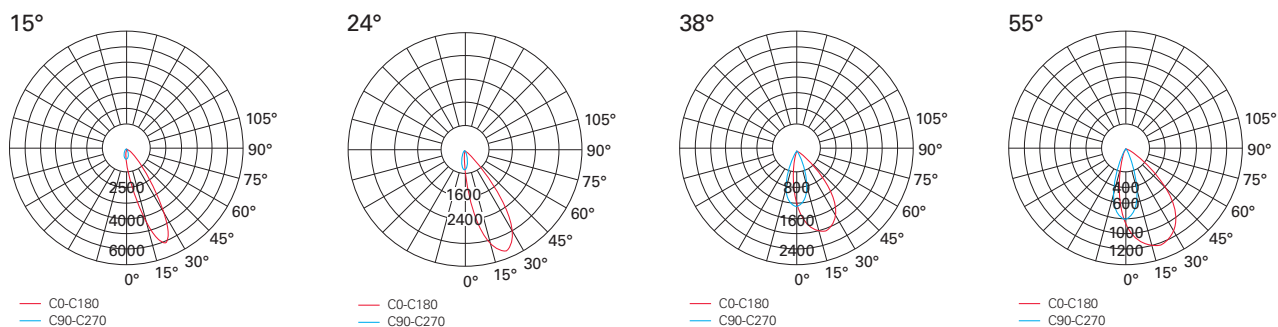

Versioni dimmerabili / Dimmable versions

con regolazione via cavo
wired dimmable

versioni version	suffisso codice code suffix	nota note	esempio example
Push 1...10 V	DM	per ordinare la versione PUSH / 1...10 V aggiungere DM alla fine del codice to order the PUSH / 1...10 V version add DM to the end of the code	RTL-----DM
DALI	DA	per ordinare la versione DALI aggiungere DA alla fine del codice to order the DALI version add DA to the end of the code	RTL-----DA

con controllo della luce wireless Bluetooth
wireless Bluetooth lighting control

versioni version	suffisso codice code suffix	nota note	esempio example
PAN Digital	PD	per ordinare la versione per smart application PAN Digital aggiungere PD alla fine del codice to order the version for smart application PAN Digital add PD to the end of the code	RTL-----PD
CASAMBI	CA	per ordinare la versione per smart application CASAMBI aggiungere CA alla fine del codice to order the version for smart application CASAMBI add CA to the end of the code	RTL-----CA

versioni Bluetooth per "smart application"; vedi dettagli alle pagine 8 - 9
Bluetooth versions for "smart application"; see details to pages 8 - 9

Kit Emergenza / Emergency Kit

autonomia operation time	tempo di accensione switching time	tempo di ricarica recharging time	foro di incasso minimo (*) minimum recessing hole (*)	IP IP	peso weight	codice code
1 ora / 1 hour	0,5 sec.	24 h.	Ø 75 mm.	IP20	0,43 kg	DRV9092
3 ora / 3 hour	0,5 sec.	24 h.	Ø 100mm.	IP20	0,88 kg	DRV9091

(*) per l'installazione in controsoffitto verificare la compatibilità con il foro di incasso; vedi dettagli a pagina 546
(* for installation in false ceiling check the compatibility with the recessing hole; see details to page 546)

Widot AS

CRI > 90

CCT CCT	potenza power	ottica optic	codice code	CRI CRI	MacAdam SDCM	flusso apparecchio lumen output	colore colour
2700 K 220 ÷ 240 V	10 W	15°	RTL23541	> 90	< 3	777 lm	bianco / <i>white</i>
		24°	RTL23542	> 90	< 3	784 lm	bianco / <i>white</i>
		38°	RTL23543	> 90	< 3	790 lm	bianco / <i>white</i>
		55°	RTL23544	> 90	< 3	797 lm	bianco / <i>white</i>
	15 W	15°	RTL23545	> 90	< 3	1204 lm	bianco / <i>white</i>
		24°	RTL23546	> 90	< 3	1208 lm	bianco / <i>white</i>
		38°	RTL23547	> 90	< 3	1217 lm	bianco / <i>white</i>
		55°	RTL23548	> 90	< 3	1228 lm	bianco / <i>white</i>
3000 K 220 ÷ 240 V	10 W	15°	RTL23501	> 90	< 3	804 lm	bianco / <i>white</i>
		24°	RTL23503	> 90	< 3	812 lm	bianco / <i>white</i>
		38°	RTL23505	> 90	< 3	824 lm	bianco / <i>white</i>
		55°	RTL23507	> 90	< 3	906 lm	bianco / <i>white</i>
	15 W	15°	RTL23509	> 90	< 3	1249 lm	bianco / <i>white</i>
		24°	RTL23511	> 90	< 3	1252 lm	bianco / <i>white</i>
		38°	RTL23513	> 90	< 3	1261 lm	bianco / <i>white</i>
		55°	RTL23515	> 90	< 3	1272 lm	bianco / <i>white</i>
4000 K 220 ÷ 240 V	10 W	15°	RTL23502	> 90	< 3	865 lm	bianco / <i>white</i>
		24°	RTL23504	> 90	< 3	863 lm	bianco / <i>white</i>
		38°	RTL23506	> 90	< 3	868 lm	bianco / <i>white</i>
		55°	RTL23508	> 90	< 3	875 lm	bianco / <i>white</i>
	15 W	15°	RTL23510	> 90	< 3	1320 lm	bianco / <i>white</i>
		24°	RTL23512	> 90	< 3	1323 lm	bianco / <i>white</i>
		38°	RTL23514	> 90	< 3	1332 lm	bianco / <i>white</i>
		55°	RTL23516	> 90	< 3	1343 lm	bianco / <i>white</i>

Programma Nemo / Widot

Ricambi / Spare Parts

Riflettori estetici / Aestetical reflectors

	finitura <i>finishing</i>	per versione <i>for model</i>	codice <i>code</i>
Nemo Adj	satinata	10 / 15 W	RTL29111
Nemo TL Adj	<i>matt</i>	24 W	RTL29113
		33 W	RTL29114
		42 W	RTL29115
versioni tonde e quadrate <i>rounded and squared models</i>	speculare <i>mirror</i>	10 / 15 W	RTL29211
		24 W	RTL29213
		33 W	RTL29214
		42 W	RTL29215
	nero titanio <i>titanium</i>	10 / 15 W	RTL29311
		24 W	RTL29313
		33 W	RTL29314
		42 W	RTL29315
	oro lucido <i>gold</i>	10 / 15 W	RTL29411
		24 W	RTL29413
		33 W	RTL29414
		42 W	RTL29415
	bianco opaco <i>matt white</i>	10 / 15 W	RTL29511
		24 W	RTL29513
		33 W	RTL29514
		42 W	RTL29515
Nemo Fix	satinata	10 / 15 W	RTL29121R
Nemo TL Fix	<i>matt</i>	24 W	RTL29123R
		33 W	RTL29124R
		42 W	RTL29125R
versioni tonde e quadrate <i>rounded and squared models</i>	speculare <i>mirror</i>	10 / 15 W	RTL29221R
		24 W	RTL29223R
		33 W	RTL29224R
		42 W	RTL29225R
	nero titanio <i>titanium</i>	10 / 15 W	RTL29321R
		24 W	RTL29323R
		33 W	RTL29324R
		42 W	RTL29325R
	oro lucido <i>gold</i>	10 / 15 W	RTL29421R
		24 W	RTL29423R
		33 W	RTL29424R
		42 W	RTL29425R
	bianco opaco <i>matt white</i>	10 / 15 W	RTL29521R
		24 W	RTL29523R
		33 W	RTL29524R
		42 W	RTL29525R
Nemo Comfort	bianco opaco	10 / 15 W	RTL29231
Nemo TL Comfort	<i>matt white</i>	24 W	RTL29233
		33 W	RTL29234
		42 W	RTL29235
solo versioni tonde <i>only rounded models</i>	satinata	10 / 15 W	RTL29131
	<i>matt</i>	24 W	RTL29133
		33 W	RTL29134
		42 W	RTL29135
	nero opaco <i>matt black</i>	10 / 15 W	RTL29331
		24 W	RTL29333
		33 W	RTL29334
		42 W	RTL29335
	bronzo opaco <i>matt bronze</i>	10 / 15 W	RTL29431
		24 W	RTL29433
		33 W	RTL29434
		42 W	RTL29435

Riflettori estetici / *Aestetical reflectors*

	finitura <i>finishing</i>	per versione <i>for model</i>	codice <i>code</i>
Nemo Comfort	bianco opaco	10 / 15 W	RTL29241
Nemo TL Comfort	<i>matt white</i>	24 W	RTL29243
		33 W	RTL29244
		42 W	RTL29245
solo versioni quadrate <i>only squared models</i>	satinata	10 / 15 W	RTL29141
	<i>matt</i>	24 W	RTL29143
		33 W	RTL29144
		42 W	RTL29145
	nero opaco	10 / 15 W	RTL29341
	<i>matt black</i>	24 W	RTL29343
		33 W	RTL29344
		42 W	RTL29345
	bronzo opaco	10 / 15 W	RTL29441
	<i>matt bronze</i>	24 W	RTL29443
		33 W	RTL29444
		42 W	RTL29445

Lenti ottiche / *Optical lenses*

	ottica <i>optics</i>	per versione <i>for model</i>	codice <i>code</i>
Nemo Adj / Fix / Comfort	15°	10 / 15 W	RTL27011
Nemo TL Adj / Fix / Comfort		24 W	RTL27021
Nemo IP54		33 W	RTL27031
Widot		42 W	RTL27041
Widot AS	24°	10 / 15 W	RTL27012
Accent		24 W	RTL27022
		33 W	RTL27032
		42 W	RTL27042
tutte le versioni <i>all models</i>	38°	10 / 15 W	RTL27013
		24 W	RTL27023
		33 W	RTL27033
		42 W	RTL27043
	55°	10 / 15 W	RTL27014
		24 W	RTL27024
		33 W	RTL27034
		42 W	RTL27044

Moby



□ IP40 UP TO 95 lm / W L80 / B20 50.000 h. CRI > 90 SDCM < 3   5 YEARS WARRANTY

I proiettori della serie Moby sono indicati per illuminare le aree espositive degli ambienti commerciali e dei negozi: sono equipaggiati con driver elettronici ad alta efficienza e led CoB ad alta resa cromatica (CRI > 90 e SDCM < 3) per esaltare i colori degli oggetti illuminati grazie ad una luce intensa e brillante. I gruppi ottici sono realizzati con riflettori speculari a faccette progressivamente curve e abbinati a specifiche lenti, per ottenere un elevato rendimento ottico e una perfetta diffusione della luce. I proiettori Moby offrono la possibilità di estrarre il corpo ottico oppure di arretrarlo all'interno del controsoffitto, permettendo così la massima flessibilità e orientabilità nei puntamenti. La connessione con il driver è di tipo "fast plug" e le mollette di fissaggio permettono un'installazione senza utensili.

Projectors of the Moby series are designed to illuminate the display areas of commercial environments and shops: they are equipped with high efficiency electronic drivers and high color rendering CoB LEDs (CRI > 90 and SDCM < 3) to enhance the colors of the illuminated objects thanks to an intense and bright light. The optical groups are made by combining specific lenses with mirrored reflectors with curved and progressive facets, in order to have a high optical efficiency with a perfect light diffusion. The Moby projectors offer the possibility of extracting the optical body or moving it back into the false ceiling, thus allowing maximum flexibility and orientation in pointing. The connection with the driver is of the "fast plug" type and the fixing clips allow a tool-free installation.

- Driver remoto incluso, alimentazione 220 ÷ 240 V / 50 ÷ 60 Hz
- Accensione On / Off
- Orientabilità orizzontale 350° con stop di rotazione, estraibilità +45° -18°
- Colori bianco opaco.
- IP40
- Led CoB 3000 K / 4000 K con resa cromatica CRI > 90, MacAdam SDCM < 3
- No UV, No IR
- Emissioni luminose da 1132 lm a 4000 lm
- Efficienza luminosa fino a 96 lm/W
- Efficienza energetica A
- Lifetime L80 / B20 – 50.000 h
- Lenti ottiche da 15° / 24° / 36° / 60° (intercambiabili come accessori)
- Classe "II"
- Temperatura ambiente di esercizio da -20°C a +45°C
- Certificazione CE, RoHS
- 5 anni di garanzia

- *Remote driver included, suitable for track 220 ÷ 240 V / 50 ÷ 60 Hz*
- *Ceiling mounted with base as accessory*
- *Switching On / Off*
- *Track plug adaptor, 3 switching way with selector and security lock system*
- *Adjustable horizontal rotation 350° with stop, vertical aiming +45° pull out -18° push in*
- *Colours available matt white and matt black*
- *IP40*
- *Led CoB 3000 K / 4000 K – CRI > 90, MacAdam SDCM < 3*
- *No UV, No IR*
- *Light output from 1400 lm up to 4000 lm*
- *Efficacy up to 96 lm/W*
- *Energy Label A*
- *Lifetime L80 / B20 – 50.000 h*
- *Optic lens 15° / 24° / 36° / 60° (interchangeable as accessory)*
- *Class "II"*
- *Operating from -20°C up to +45°C*
- *Compliance CE, RoHS*
- *5 years warranty*

Moby



Doppia rotazione

Double rotation

Massima orientabilità del vano ottico, con rotazione orizzontale di 350° con stop e doppia rotazione verticale, esterna fino a 45° e interna fino a 18°

Maximum adjustability thanks to horizontal rotation at 350° with stop and double vertical rotation, pull out 45° and pull in 18°

Luce morbida e precisa

Precise and nuanced light

Ottiche a faccette curvate progressive in abbinamento a lenti diffusive permettono di ottenere fasci di luce precisi e al tempo stesso sfumati ai bordi

Lighting effects precise and nuanced at the edge in order to light with soft shadows thanks to the diffusive lens combined with mirroring reflectors with progressive curved faceted

CRI > 90 - SDCM < 3

Elevata qualità cromatica della luce grazie a led "prime brand"
Ottima resa del colore con CRI > 90
Minimo scostamento cromatico con MacAdam SDCM < 3

*High lighting performance thanks to "prime brand" led
High color rendition CRI > 90
Deviation colour matching MacAdam SDCM < 3*



Moby

Resa cromatica / *Color rendering*

CRI

R1 - R15

3000 K
CRI: 91,8

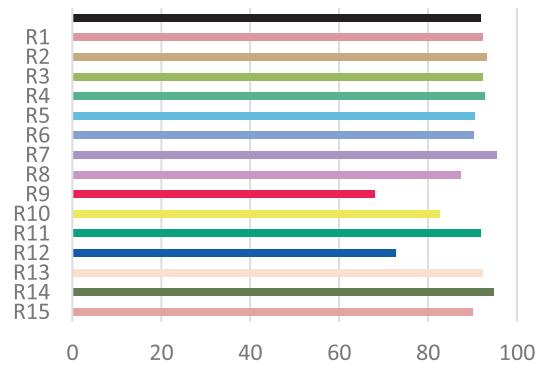
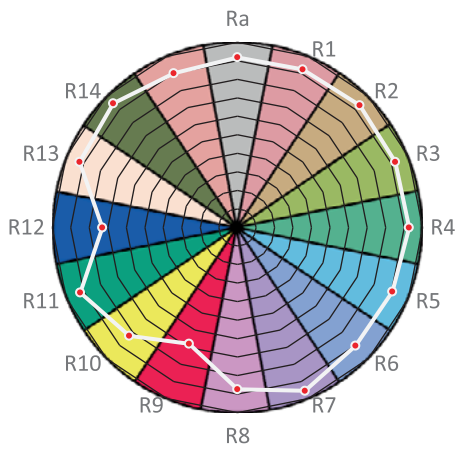

4000 K
CRI: 90,8

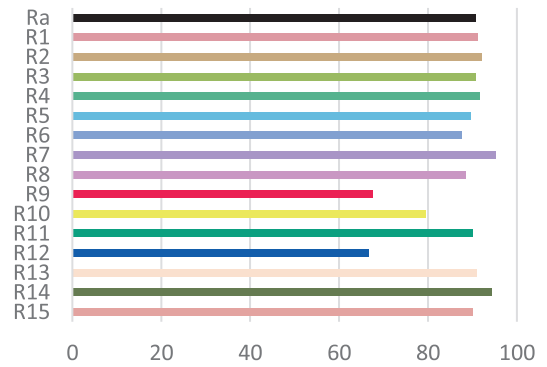
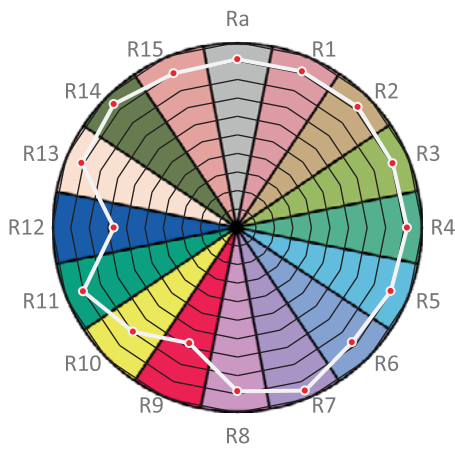

TM-30

Rf / Rg plot

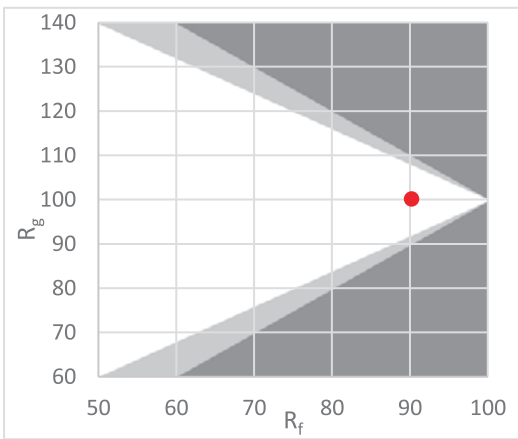

Rf 90,2
Rg 100,2

Color vector graphic

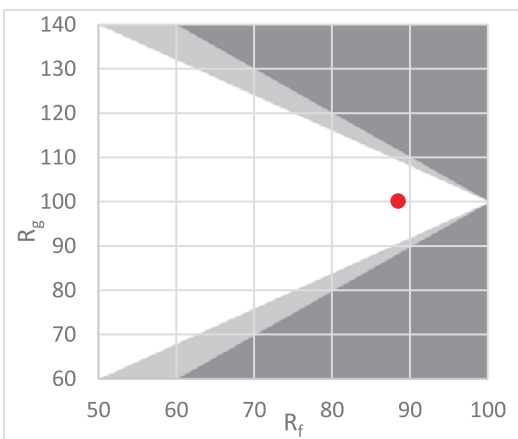
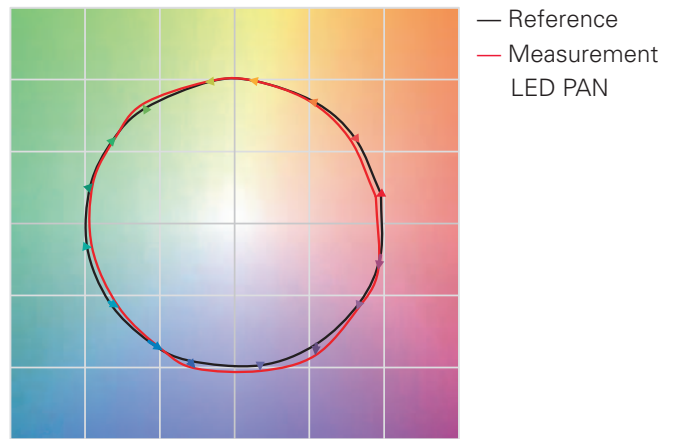



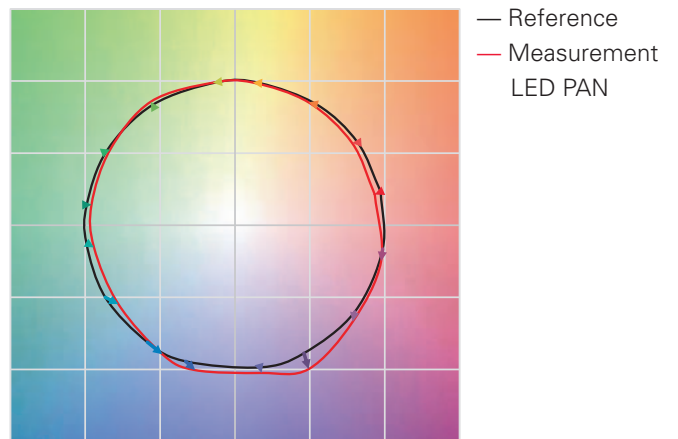

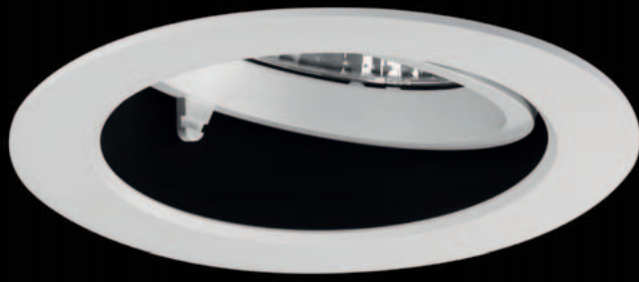



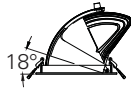

Rf 88,5
Rg 100,2

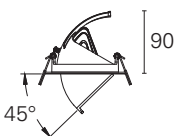

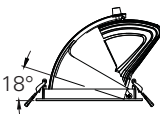

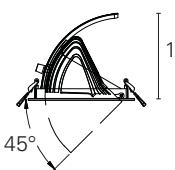
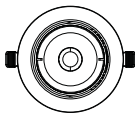
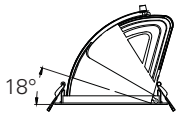
Moby

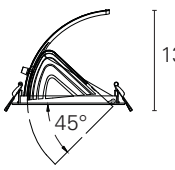
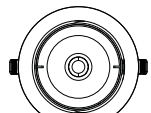
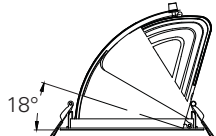
Dimensioni / Dimensions

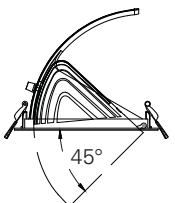
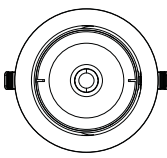
<p>12 W 1150 lumen</p>	 <p>⊕ ø90 mm.  0,32</p>	 <p>90 45°</p>	 <p>ø105</p>
<p>24 W 2300 lumen</p>	 <p>⊕ ø125 mm.  0,74</p>	 <p>114 45°</p>	 <p>ø140</p>
<p>33 W 3200 lumen</p>	 <p>⊕ ø145 mm.  0,86</p>	 <p>130 45°</p>	 <p>ø158</p>
<p>42 W 4000 lumen</p>	 <p>⊕ ø170 mm.  1,28</p>	 <p>159 45°</p>	 <p>ø188</p>

Moby

Ottiche / Optics

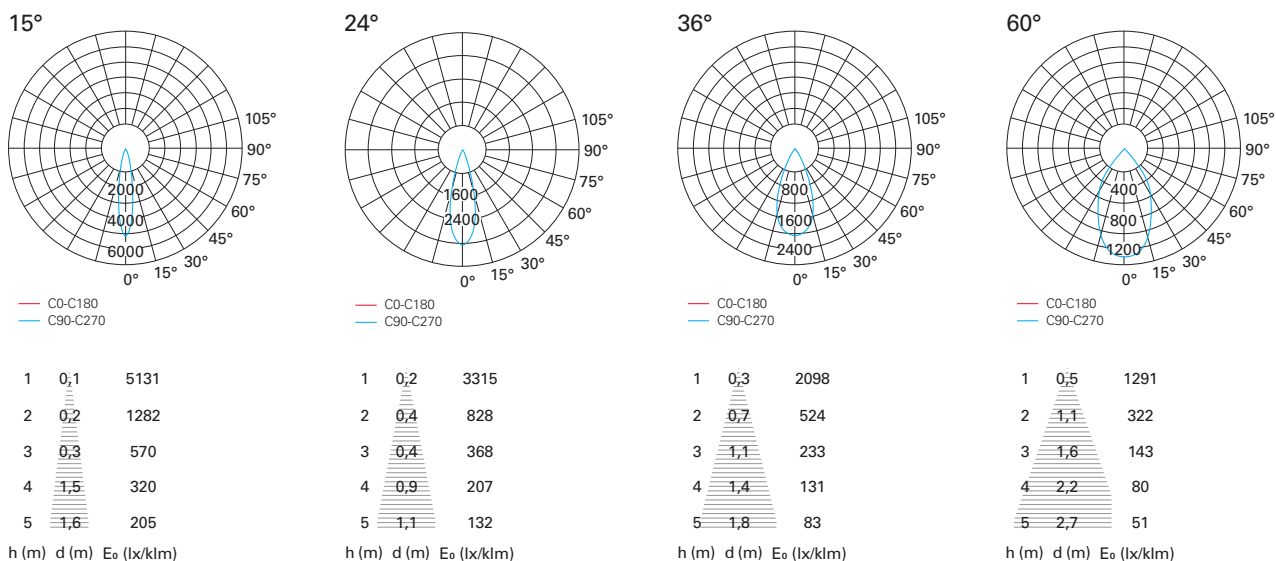

Versioni dimmerabili / Dimmable versions

con regolazione via cavo
wired dimmable

versioni version	suffisso codice code suffix	nota note	esempio example
Push 1...10 V	DM	per ordinare la versione PUSH / 1...10 V aggiungere DM alla fine del codice to order the PUSH / 1...10 V version add DM to the end of the code	RTL-----DM
DALI	DA	per ordinare la versione DALI aggiungere DA alla fine del codice to order the DALI version add DA to the end of the code	RTL-----DA

con controllo della luce wireless Bluetooth
wireless Bluetooth lighting control

versioni version	suffisso codice code suffix	nota note	esempio example
PAN Digital	PD	per ordinare la versione per smart application PAN Digital aggiungere PD alla fine del codice to order the version for smart application PAN Digital add PD to the end of the code	RTL-----PD
CASAMBI	CA	per ordinare la versione per smart application CASAMBI aggiungere CA alla fine del codice to order the version for smart application CASAMBI add CA to the end of the code	RTL-----CA

versioni Bluetooth per "smart application"; vedi dettagli alle pagine 8 - 9
Bluetooth versions for "smart application"; see details to pages 8 - 9

Kit Emergenza / Emergency Kit

autonomia operation time	tempo di accensione switching time	tempo di ricarica recharging time	foro di incasso minimo (*) minimum recessing hole (*)	IP IP	peso weight	codice code
1 ora / 1 hour	0,5 sec.	24 h.	Ø 75 mm.	IP20	0,43 kg	DRV9092
3 ora / 3 hour	0,5 sec.	24 h.	Ø 100mm.	IP20	0,88 kg	DRV9091

(*) per l'installazione in controsoffitto verificare la compatibilità con il foro di incasso; vedi dettagli a pagina 546
(* for installation in false ceiling check the compatibility with the recessing hole; see details to page 546)

Moby

CRI > 90

versione version	potenza power	ottica optic	codice code	temp. di colore light temperature	CRI CRI	MacAdam SDCM	flusso apparecchio light output	colore colour
On / Off 220 ÷ 240 V	12 W	15°	RTL30101	3000 K	> 90	< 3	1132 lm	bianco / white
			RTL30102	4000 K	> 90	< 3	1144 lm	bianco / white
		24°	RTL30103	3000 K	> 90	< 3	1134 lm	bianco / white
			RTL30104	4000 K	> 90	< 3	1147 lm	bianco / white
		36°	RTL30105	3000 K	> 90	< 3	1136 lm	bianco / white
			RTL30106	4000 K	> 90	< 3	1150 lm	bianco / white
	24 W	15°	RTL30201	3000 K	> 90	< 3	2285 lm	bianco / white
			RTL30202	4000 K	> 90	< 3	2298 lm	bianco / white
		24°	RTL30203	3000 K	> 90	< 3	2288 lm	bianco / white
			RTL30204	4000 K	> 90	< 3	2302 lm	bianco / white
		36°	RTL30205	3000 K	> 90	< 3	2292 lm	bianco / white
			RTL30206	4000 K	> 90	< 3	2307 lm	bianco / white
	33 W	15°	RTL30301	3000 K	> 90	< 3	3168 lm	bianco / white
			RTL30302	4000 K	> 90	< 3	3180 lm	bianco / white
		24°	RTL30303	3000 K	> 90	< 3	3172 lm	bianco / white
			RTL30304	4000 K	> 90	< 3	3185 lm	bianco / white
		36°	RTL30305	3000 K	> 90	< 3	3177 lm	bianco / white
			RTL30306	4000 K	> 90	< 3	3190 lm	bianco / white
		60°	RTL30307	3000 K	> 90	< 3	3180 lm	bianco / white
			RTL30308	4000 K	> 90	< 3	3194 lm	bianco / white
	42 W	15°	RTL30401	3000 K	> 90	< 3	3990 lm	bianco / white
			RTL30402	4000 K	> 90	< 3	4005 lm	bianco / white
		24°	RTL30403	3000 K	> 90	< 3	3994 lm	bianco / white
			RTL30404	4000 K	> 90	< 3	4009 lm	bianco / white
36°		RTL30405	3000 K	> 90	< 3	4000 lm	bianco / white	
		RTL30406	4000 K	> 90	< 3	4015 lm	bianco / white	
60°		RTL30407	3000 K	> 90	< 3	4004 lm	bianco / white	
		RTL30408	4000 K	> 90	< 3	4021 lm	bianco / white	

Accent



Drop

Side

□ IP40 ^{UP TO} 99 lm / W L80 / B20 50.000 h. CRI > 90 SDCM < 3   5 YEARS WARRANTY

Equipaggiato con gli stessi moduli led della serie Nemo, Accent è il downlight ideale per tutti i progetti di interior design dove è necessario ricreare accenti di luce ben definiti in assenza di abbagliamento. Grazie alla sorgente led arretrata e completamente nascosta alla vista, Accent ha un cut-off di 40° e offre il massimo del comfort visivo creando accenti di luce uniforme precisi e ben definiti; in particolare la versione Drop è l'ideale per effetti spot sul piano orizzontale mentre la versione Side permette di inclinare il modulo ottico per emissioni di luce laterali; Entrambe le versioni sono comunque orientabili per garantire la massima flessibilità dell'impianto. Tutte le versioni si installano in un foro di incasso Ø 65 mm.

Accent is the downlight equipped with the same LED modules of the Nemo series, it is ideal for all interior design projects where it is necessary to recreate well-defined light accents in the absence of glare. Accent has the LED source set back and completely hidden from view and with a 40 ° cut-off it offers maximum visual comfort by creating precise and well-defined uniform light accents. Particularly the Drop version is ideal for spot effects on the horizontal plane while the Side version allows you to tilt the optical module for lateral light emissions. In any case, both versions are adjustable to ensure maximum system flexibility. All versions are installed in a Ø 65 mm recessed hole.



- Alimentazione 220÷240 V / 50÷60 Hz - Classe "II"
- Driver remoto con connessione "fast plug"
- Alimentazioni: On / Off, Dimmerabile Multifunzione (Push / 1...10 V), DALI.
- Kit emergenza 1h / 3h. accessorio remoto.
- Versioni con controllo digitale "Casambi" o "Pan Digital System"
- Installazione in controsoffitti con spessori da 5 mm. a 25 mm.
- Frame simmetrico e asimmetrico
- Modulo ottico inclinabile di 30°
- Colore anello strutturale: bianco opaco.
- IP40 vano ottico; IP20 vano incassato
- Led CoB 2700 K / 3000 K / 4000 K con resa cromatica CRI > 90 e MacAdam SDCM < 3
- No UV, No IR
- Emissioni luminose da 890 lm a 1500 lumen
- Efficacia luminosa fino a 100 lm/W
- Efficienza energetica A
- Lifetime L80 / B20 – 50.000 h
- Lenti ottiche da 15° / 24° / 32
- Elevato controllo dell'abbagliamento Cut-off 40°
- UGR < 16 / < 17
- Temperatura ambiente di esercizio da -20°C a +45°C
- Certificazione CE, RoHS
- 5 anni di garanzia

- *Feeding 220÷240 V / 50÷60 Hz - Class "II"*
- *Remote driver with "fast plug" connectors*
- *Switching: On / Off, Multifunction Dimmable (Push / 1... 10 V), DALI.*
- *Emergency Kit 1h / 3h as remote accessory.*
- *Digital Control Versions "Casambi" or "Pan Digital System"*
- *Mounting on false ceiling depth from 5 mm. up to 25 mm.*
- *Frame simmetrico e asimmetrico*
- *Optic module vertical aiming 30°*
- *Ring colour: matt white.*
- *IP40 down; IP20 up*
- *Led CoB 2700K / 3000 K / 4000 K; CRI > 90; MacAdam SDCM < 3*
- *No UV, No IR*
- *Light output from 890 lm up to 1500 lm*
- *Efficacy up to 100 lm/W*
- *Energy Label A*
- *Lifetime L80 / B20 – 50.000 h*
- *Optic lens 15° / 24° / 32*
- *Cut-off 40°*
- *UGR < 16 / < 17*
- *Operating from -20°C up to +45°C*
- *Compliance CE, RoHS*
- *5 years warranty*

Accent Drop



Ottiche / Optics

15° 4000 K

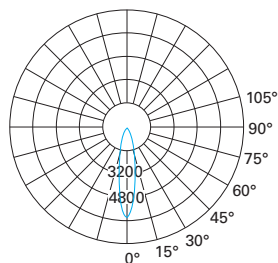

— C0-C180
— C90-C270

	10 W	15 W
1.0	0,3	5921 7870
2.0	0,6	1480 1967
3.0	1,0	658 874
4.0	1,4	370 492
5.0	1,7	237 315
h (m)	d (m)	E ₀ (lx)

24° 4000 K

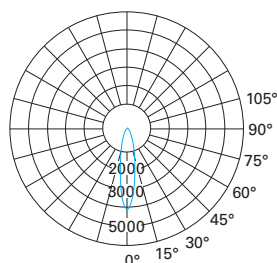

— C0-C180
— C90-C270

	10 W	15 W
1.0	0,4	3988 6220
2.0	0,9	997 1555
3.0	1,4	443 691
4.0	1,8	249 389
5.0	2,3	160 249
h (m)	d (m)	E ₀ (lx)

32° 4000 K

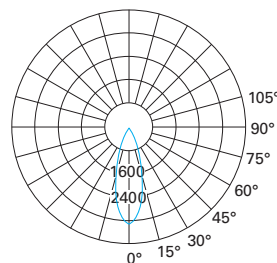

— C0-C180
— C90-C270

	10 W	15 W
1.0	0,5	2861 4429
2.0	1,1	715 1107
3.0	1,7	318 492
4.0	2,2	179 277
5.0	2,8	114 177
h (m)	d (m)	E ₀ (lx)

Versioni dimmerabili / Dimmable versions

con regolazione via cavo
wired dimmable

versioni version	suffisso codice code suffix	nota note	esempio example
Push 1...10 V	DM	per ordinare la versione PUSH / 1...10 V aggiungere DM alla fine del codice <i>to order the PUSH / 1...10 V version add DM to the end of the code</i>	RTL-----DM
DALI	DA	per ordinare la versione DALI aggiungere DA alla fine del codice <i>to order the DALI version add DA to the end of the code</i>	RTL-----DA

con controllo della luce wireless Bluetooth
wireless Bluetooth lighting control

versioni version	suffisso codice code suffix	nota note	esempio example
PAN Digital	PD	per ordinare la versione per smart application PAN Digital aggiungere PD alla fine del codice <i>to order the version for smart application PAN Digital add PD to the end of the code</i>	RTL-----PD
CASAMBI	CA	per ordinare la versione per smart application CASAMBI aggiungere CA alla fine del codice <i>to order the version for smart application CASAMBI add CA to the end of the code</i>	RTL-----CA

versioni Bluetooth per "smart application"; **vedi dettagli alle pagine 8 - 9**
Bluetooth versions for "smart application"; see details to pages 8 - 9

Kit Emergenza / Emergency Kit

autonomia operation time	tempo di accensione switching time	tempo di ricarica recharging time	foro di incasso minimo (*) minimum recessing hole (*)	IP IP	peso weight	codice code
1 ora / 1 hour	0,5 sec.	24 h.	Ø 75 mm.	IP20	0,43 kg	DRV9092
3 ora / 3 hour	0,5 sec.	24 h.	Ø 100mm.	IP20	0,88 kg	DRV9091

(*) per l'installazione in controsoffitto verificare la compatibilità con il foro di incasso; **vedi dettagli a pagina 546**
() for installation in false ceiling check the compatibility with the recessing hole; see details to page 546*

Dimensioni / Dimensions

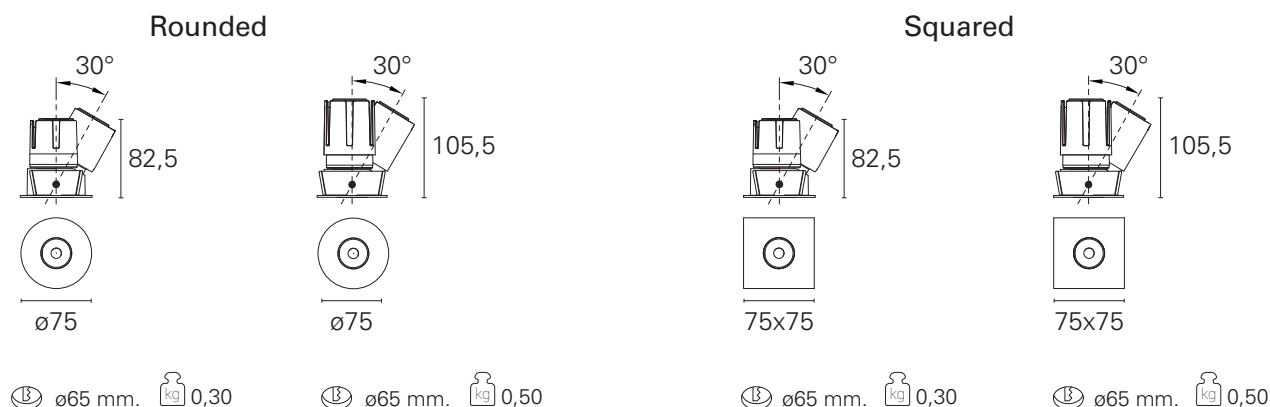

Accent Drop

CRI > 90 - SDCM < 3

versione version	potenza power	ottica optic	codice code	CCT CCT	CRI CRI	MacAdam SDCM	flusso apparecchio light output	UGR UGR	colore colour
rounded	10W	15°	RTL19110	2700 K	> 90	< 3	888 lm	< 16	bianco / white
			RTL19111	3000 K	> 90	< 3	918 lm	< 16	bianco / white
			RTL19112	4000 K	> 90	< 3	956 lm	< 16	bianco / white
		24°	RTL19113	2700 K	> 90	< 3	894 lm	< 16	bianco / white
			RTL19114	3000 K	> 90	< 3	924 lm	< 16	bianco / white
			RTL19115	4000 K	> 90	< 3	958 lm	< 16	bianco / white
		32°	RTL19116	2700 K	> 90	< 3	807 lm	< 16	bianco / white
			RTL19117	3000 K	> 90	< 3	834 lm	< 16	bianco / white
			RTL19118	4000 K	> 90	< 3	872 lm	< 16	bianco / white
	15W	15°	RTL19119	2700 K	> 90	< 3	1359 lm	< 16	bianco / white
			RTL19120	3000 K	> 90	< 3	1408 lm	< 17	bianco / white
			RTL19121	4000 K	> 90	< 3	1486 lm	< 17	bianco / white
		24°	RTL19122	2700 K	> 90	< 3	1363 lm	< 17	bianco / white
			RTL19123	3000 K	> 90	< 3	1412 lm	< 17	bianco / white
			RTL19124	4000 K	> 90	< 3	1494 lm	< 17	bianco / white
		32°	RTL19125	2700 K	> 90	< 3	1234 lm	< 17	bianco / white
			RTL19126	3000 K	> 90	< 3	1278 lm	< 17	bianco / white
			RTL19127	4000 K	> 90	< 3	1350 lm	< 17	bianco / white
squared	10W	15°	RTL19310	2700 K	> 90	< 3	888 lm	< 16	bianco / white
			RTL19311	3000 K	> 90	< 3	918 lm	< 16	bianco / white
			RTL19312	4000 K	> 90	< 3	956 lm	< 16	bianco / white
		24°	RTL19313	2700 K	> 90	< 3	894 lm	< 16	bianco / white
			RTL19314	3000 K	> 90	< 3	924 lm	< 16	bianco / white
			RTL19315	4000 K	> 90	< 3	958 lm	< 16	bianco / white
		32°	RTL19316	2700 K	> 90	< 3	807 lm	< 16	bianco / white
			RTL19317	3000 K	> 90	< 3	834 lm	< 16	bianco / white
			RTL19318	4000 K	> 90	< 3	872 lm	< 16	bianco / white
	15W	15°	RTL19319	2700 K	> 90	< 3	1359 lm	< 16	bianco / white
			RTL19320	3000 K	> 90	< 3	1408 lm	< 17	bianco / white
			RTL19321	4000 K	> 90	< 3	1486 lm	< 17	bianco / white
		24°	RTL19322	2700 K	> 90	< 3	1363 lm	< 17	bianco / white
			RTL19323	3000 K	> 90	< 3	1412 lm	< 17	bianco / white
			RTL19324	4000 K	> 90	< 3	1494 lm	< 17	bianco / white
		32°	RTL19325	2700 K	> 90	< 3	1234 lm	< 17	bianco / white
			RTL19326	3000 K	> 90	< 3	1278 lm	< 17	bianco / white
			RTL19327	4000 K	> 90	< 3	1350 lm	< 17	bianco / white

Accent Side

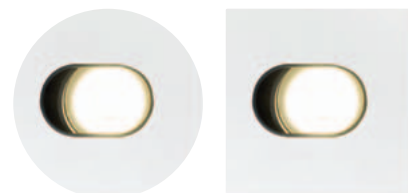

Ottiche / Optics

15° 4000 K

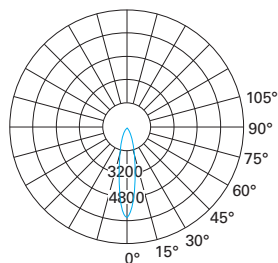

— C0-C180
— C90-C270

	10 W	15 W
1.0	0,3	5921 7870
2.0	0,6	1480 1967
3.0	1,0	658 874
4.0	1,4	370 492
5.0	1,7	237 315
h (m)	d (m)	E ₀ (lx)

24° 4000 K

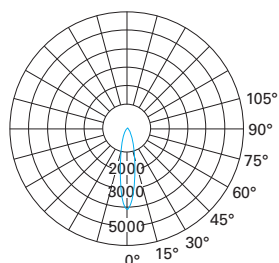

— C0-C180
— C90-C270

	10 W	15 W
1.0	0,4	3988 6220
2.0	0,9	997 1555
3.0	1,4	443 691
4.0	1,8	249 389
5.0	2,3	160 249
h (m)	d (m)	E ₀ (lx)

32° 4000 K

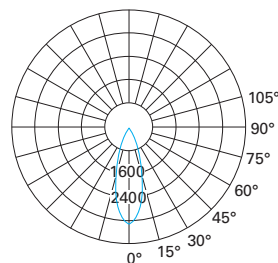

— C0-C180
— C90-C270

	10 W	15 W
1.0	0,5	2861 4429
2.0	1,1	715 1107
3.0	1,7	318 492
4.0	2,2	179 277
5.0	2,8	114 177
h (m)	d (m)	E ₀ (lx)

Versioni dimmerabili / Dimmable versions

con regolazione via cavo
wired dimmable

versioni version	suffisso codice code suffix	nota note	esempio example
Push 1...10 V	DM	per ordinare la versione PUSH / 1...10 V aggiungere DM alla fine del codice <i>to order the PUSH / 1...10 V version add DM to the end of the code</i>	RTL-----DM
DALI	DA	per ordinare la versione DALI aggiungere DA alla fine del codice <i>to order the DALI version add DA to the end of the code</i>	RTL-----DA

con controllo della luce wireless Bluetooth
wireless Bluetooth lighting control

versioni version	suffisso codice code suffix	nota note	esempio example
PAN Digital	PD	per ordinare la versione per smart application PAN Digital aggiungere PD alla fine del codice <i>to order the version for smart application PAN Digital add PD to the end of the code</i>	RTL-----PD
CASAMBI	CA	per ordinare la versione per smart application CASAMBI aggiungere CA alla fine del codice <i>to order the version for smart application CASAMBI add CA to the end of the code</i>	RTL-----CA

versioni Bluetooth per "smart application"; vedi dettagli alle pagine 8 - 9
Bluetooth versions for "smart application"; see details to pages 8 - 9

Kit Emergenza / Emergency Kit

autonomia operation time	tempo di accensione switching time	tempo di ricarica recharging time	foro di incasso minimo (*) minimum recessing hole (*)	IP IP	peso weight	codice code
1 ora / 1 hour	0,5 sec.	24 h.	Ø 75 mm.	IP20	0,43 kg	DRV9092
3 ora / 3 hour	0,5 sec.	24 h.	Ø 100mm.	IP20	0,88 kg	DRV9091

(*) per l'installazione in controsoffitto verificare la compatibilità con il foro di incasso; vedi dettagli a pagina 546
() for installation in false ceiling check the compatibility with the recessing hole; see details to page 546*

Dimensioni / Dimensions

Rounded

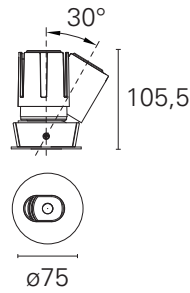
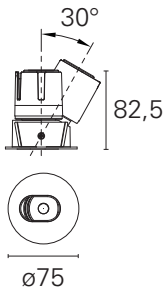

Squared

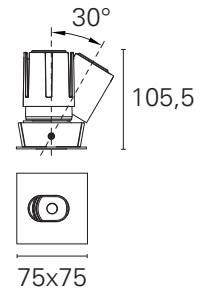
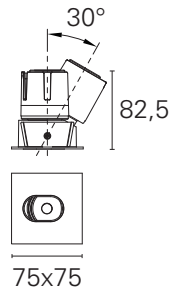

⊕ ø65 mm. 0,30

⊕ ø65 mm. 0,50

⊕ ø65 mm. 0,30

⊕ ø65 mm. 0,50

Accent Side

CRI > 90 - SDCM < 3

versione version	potenza power	ottica optic	codice code	CCT CCT	CRI CRI	MacAdam SDCM	flusso apparecchio light output	UGR UGR	colore colour
rounded	10 W	15°	RTL19210	2700 K	> 90	< 3	888 lm	< 16	bianco / white
			RTL19211	3000 K	> 90	< 3	918 lm	< 16	bianco / white
			RTL19212	4000 K	> 90	< 3	956 lm	< 16	bianco / white
		24°	RTL19213	2700 K	> 90	< 3	894 lm	< 16	bianco / white
			RTL19214	3000 K	> 90	< 3	924 lm	< 16	bianco / white
			RTL19215	4000 K	> 90	< 3	958 lm	< 16	bianco / white
		32°	RTL19216	2700 K	> 90	< 3	807 lm	< 16	bianco / white
			RTL19217	3000 K	> 90	< 3	834 lm	< 16	bianco / white
			RTL19218	4000 K	> 90	< 3	872 lm	< 16	bianco / white
	15 W	15°	RTL19219	2700 K	> 90	< 3	1359 lm	< 16	bianco / white
			RTL19220	3000 K	> 90	< 3	1408 lm	< 17	bianco / white
			RTL19221	4000 K	> 90	< 3	1486 lm	< 17	bianco / white
		24°	RTL19222	2700 K	> 90	< 3	1363 lm	< 17	bianco / white
			RTL19223	3000 K	> 90	< 3	1412 lm	< 17	bianco / white
			RTL19224	4000 K	> 90	< 3	1494 lm	< 17	bianco / white
32°		RTL19225	2700 K	> 90	< 3	1234 lm	< 17	bianco / white	
		RTL19226	3000 K	> 90	< 3	1278 lm	< 17	bianco / white	
		RTL19227	4000 K	> 90	< 3	1350 lm	< 17	bianco / white	
squared	10 W	15°	RTL19410	2700 K	> 90	< 3	888 lm	< 16	bianco / white
			RTL19411	3000 K	> 90	< 3	918 lm	< 16	bianco / white
			RTL19412	4000 K	> 90	< 3	956 lm	< 16	bianco / white
		24°	RTL19413	2700 K	> 90	< 3	894 lm	< 16	bianco / white
			RTL19414	3000 K	> 90	< 3	924 lm	< 16	bianco / white
			RTL19415	4000 K	> 90	< 3	958 lm	< 16	bianco / white
		32°	RTL19416	2700 K	> 90	< 3	807 lm	< 16	bianco / white
			RTL19417	3000 K	> 90	< 3	834 lm	< 16	bianco / white
			RTL19418	4000 K	> 90	< 3	872 lm	< 16	bianco / white
	15 W	15°	RTL19419	2700 K	> 90	< 3	1359 lm	< 16	bianco / white
			RTL19420	3000 K	> 90	< 3	1408 lm	< 17	bianco / white
			RTL19421	4000 K	> 90	< 3	1486 lm	< 17	bianco / white
		24°	RTL19422	2700 K	> 90	< 3	1363 lm	< 17	bianco / white
			RTL19423	3000 K	> 90	< 3	1412 lm	< 17	bianco / white
			RTL19424	4000 K	> 90	< 3	1494 lm	< 17	bianco / white
32°		RTL19425	2700 K	> 90	< 3	1234 lm	< 17	bianco / white	
		RTL19426	3000 K	> 90	< 3	1278 lm	< 17	bianco / white	
		RTL19427	4000 K	> 90	< 3	1350 lm	< 17	bianco / white	

Bobby



□ IP40 ^{UP TO} 99 lm / W L80 / B20 50.000h. CRI > 90 SDCM < 3 3 YEARS WARRANTY

Bobby il downlight ideale per l'illuminazione puntuale di tutti gli ambienti. Realizzato in un unico pezzo, il corpo in pressofusione di alluminio con dissipatore integrato garantisce la massima dissipazione del calore. Con una gamma completa da 6W a 22W e un valore di UGR < 19, Bobby è in grado di produrre una luce brillante, ricca di cromie e durevole nel tempo grazie ai CoB Led di "prima scelta" con resa cromatica CRI > 90 e indice di MacAdam < 3. Il driver "flicker free" incluso completa l'apparecchio rendendo l'installazione estremamente semplice e veloce.

Bobby is the ideal downlight for the punctual illumination of all environments with a UGR value of <19. Made in one piece, the die-cast aluminum body with integrated heat sink ensures maximum heat dissipation. With a complete range from 6W to 22W, Bobby is able to produce a bright and long-lasting light thanks to the "first choice" CoB LEDs (CRI > 90 and MacAdam index <3). The included "flicker free" driver completes the appliance making installation extremely simple and fast.



- Alimentazione 220÷240 V / 50÷60 Hz - Classe "II"
- Driver remoto con connessione "fast plug"
- Alimentazioni: On / Off, Dimmerabile Multifunzione (Push / 1...10 V)
- Kit emergenza 1h / 3h. accessorio remoto.
- Versioni con controllo digitale "Casambi" o "Pan Digital System"
- Installabili in controsoffitti con spessori da 5 mm. a 25 mm. versioni 6 W e 9 W , 5 mm. a 35 mm. versioni 15 W e 22 W
- Anello strutturale verniciato bianco opaco.
- IP40 vano ottico; IP20 vano incassato
- Led CoB 3000 K / 4000 K con resa cromatica CRI > 90 e MacAdam SDCM < 3
- No UV, No IR
- Emissioni luminose da 425 lm a 2180 lumen
- Efficacia luminosa fino a 100 lm/W
- Efficienza energetica A
- Lifetime L80 / B20 – 50.000 h
- Apertura di fascio 38° con lente ottica
- UGR < 19
- Temperatura ambiente di esercizio da -20°C a +45°C
- Certificazione CE, RoHS
- 5 anni di garanzia

- *Feeding 220÷240 V / 50÷60 Hz - Class "II"*
- *Remote driver with "fast plug" connectors*
- *Switching: On / Off, Multifunction Dimmable (Push / 1...10 V).*
- *Emergency Kit 1h / 3h as remote accessory.*
- *Digital Control Versions "Casambi" or "Pan Digital System"*
- *Suitable for false ceiling depth from 5 mm. up to 25 mm. for model from 6 W to 9 W*
- *Versions 15 W and 22 W suitable for false ceiling depth from 5 mm. up to 35 mm.*
- *Ring colour matt white.*
- *IP40 down; IP20 up*
- *Led CoB 3000K / 4000K; CRI > 90; MacAdam SDCM < 3*
- *No UV, No IR*
- *Light output from 425 lm up to 2180 lm*
- *Efficacy up to 100 lm/W*
- *Energy Label A*
- *Beam aperture 38° with optic lens*
- *UGR < 19*
- *Operating from -20°C up to +45°C*
- *Lifetime L80/B20 - 50.000 h.*
- *Compliance CE, RoHS*
- *5 years warranty*

Bobby

Una gamma completa di incassati in quattro potenze e quattro dimensioni: realizzato in unico pezzo, il corpo in pressofusione di alluminio con dissipatore integrato garantisce la massima dissipazione del calore. Grazie ai CoB Led di "prima scelta" con resa cromatica CRI > 90 e indice di MacAdam < 3, Bobby garantisce una luce sempre brillante, ricca di cromie e durevole nel tempo. La lente interna ad alta efficienza e il riflettore Titanium Specular garantiscono il massimo controllo dell'abbagliamento con UGR<19. Bobby è garantito 5 anni con un lifetime L80/B20 a 50.000h. Bobby viene fornito con driver "flicker free" incluso e cavo di alimentazione completo di connettore fast-plug per facilitare e velocizzare al massimo le operazioni di installazione. Le molle di fissaggio sono complete di terminale in plastica e sono compatibili con pannelli in fibra e lastre in gesso di spessore compreso fra 5 e 35 mm.



A complete range of downlights available in 4 wattages and 4 sizes: one piece die-cast aluminum body with integrated dissipator. Thanks to prime label CoB Led with CRI > 90 and SDCM < 3, Bobby guarantees a long-lasting brilliant light. The internal high efficiency lenses and Titanium Specular reflector allows max glare control UGR < 19. Bobby has 5 years warranty with a lifetime L80/B20 at 50.000h. Bobby is equipped with "flicker free" driver and power cable completed of fast-plug connector for an easy and faster installation. Fixing springs have plastic ends. They can be used with fiber panels and plaster slabs between 5 and 35 mm thick.

Kit Emergenza / Emergency Kit

autonomia <i>operation time</i>	tempo di accensione <i>switching time</i>	tempo di ricarica <i>recharging time</i>	foro di incasso minimo (*) <i>minimum recessing hole (*)</i>	IP <i>IP</i>	peso <i>weight</i>	codice <i>code</i>
1 ora / 1 hour	0,5 sec.	24 h.	Ø 75 mm.	IP20	0,43 kg	DRV9092
3 ora / 3 hour	0,5 sec.	24 h.	Ø 100mm.	IP20	0,88 kg	DRV9091

(*) per l'installazione in controsoffitto verificare la compatibilità con il foro di incasso; vedi dettagli a pagina 546
(* for installation in false ceiling check the compatibility with the recessing hole; see details to page 546)

Dimensioni / Dimensions

6 W



ø63

⊕ ø55 mm.

Ⓚ 0,18

9 W



ø73

⊕ ø65 mm.

Ⓚ 0,20

15 W

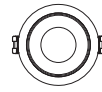
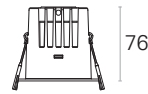

ø83

⊕ ø75 mm.

Ⓚ 0,30

22 W

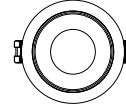
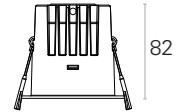

ø105

⊕ ø90 mm.

Ⓚ 0,54

Versioni 6 W e 9 W installabili in controsoffitti di spessore compreso fra 5 mm. e 25 mm.

The 6 W e 9 W models are suitable for false ceiling from 5 mm. up to 25 mm. tick.

Versioni 15 W e 22 W installabili in controsoffitti di spessore compreso fra 5 mm. e 35 mm.

The 15 W e 22 W models are suitable for false ceiling from 5 mm. up to 35 mm. tick.

Ottiche / Optics

38°

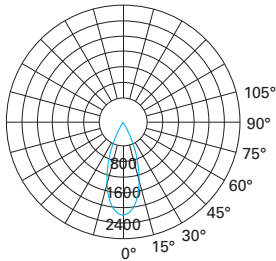

	6W	9W	15W	22W
1.0	0,6	1362	1667	3628
1.5	0,9	605	741	1612
2.0	1,2	340	417	907
2.5	1,5	218	267	580
3.0	1,8	151	185	403
h (m)	d (m)	E ₀ (lx)		

— C0-C180
— C90-C270

Bobby

CRI > 90

versione version	potenza power	codice code	ottica optic	CCT CCT	CRI CRI	MacAdam SCDM	flusso apparecchio light output	UGR UGR	colore colour
On/Off 220 ÷ 240 V	6 W	RTL12121	38°	3000 K	> 90	< 3	425 lm	< 19	bianco opaco / matt white
		RTL12122	38°	4000 K	> 90	< 3	470 lm	< 19	bianco opaco / matt white
	9 W	RTL12221	38°	3000 K	> 90	< 3	675 lm	< 19	bianco opaco / matt white
		RTL12222	38°	4000 K	> 90	< 3	745 lm	< 19	bianco opaco / matt white
	15 W	RTL12321	38°	3000 K	> 90	< 3	1345 lm	< 19	bianco opaco / matt white
		RTL12322	38°	4000 K	> 90	< 3	1410 lm	< 19	bianco opaco / matt white
22 W	RTL12421	38°	3000 K	> 90	< 3	2075 lm	< 19	bianco opaco / matt white	
	RTL12422	38°	4000 K	> 90	< 3	2180 lm	< 19	bianco opaco / matt white	
PUSH / 1...10V 220 ÷ 240 V	6 W	RTL12121DM	38°	3000 K	> 90	< 3	425 lm	< 19	bianco opaco / matt white
		RTL12122DM	38°	4000 K	> 90	< 3	470 lm	< 19	bianco opaco / matt white
	9 W	RTL12221DM	38°	3000 K	> 90	< 3	675 lm	< 19	bianco opaco / matt white
		RTL12222DM	38°	4000 K	> 90	< 3	745 lm	< 19	bianco opaco / matt white
	15 W	RTL12321DM	38°	3000 K	> 90	< 3	1345 lm	< 19	bianco opaco / matt white
		RTL12322DM	38°	4000 K	> 90	< 3	1410 lm	< 19	bianco opaco / matt white
22 W	RTL12421DM	38°	3000 K	> 90	< 3	2075 lm	< 19	bianco opaco / matt white	
	RTL12422DM	38°	4000 K	> 90	< 3	2180 lm	< 19	bianco opaco / matt white	





Studio medico "Falmed" - Pescara (PE) Italy

Jango



 UP TO 91 lm / W L80 / B20 50.000 h. CRI > 90 SDCM < 3 3 YEARS WARRANTY

La serie Jango è composta da piccoli proiettori di tipo fisso e orientabile, di forma rotonda o quadrata, con diverse profondità di incasso ed equipaggiati con driver sia on / off sia dimmerabile a taglio di fase. Una gamma completa per realizzare accenti luminosi con luce di qualità: i led CoB ad alta resa cromatica CRI > 90 e SDCM < 3 esaltano i colori degli oggetti illuminati con una luce intensa e brillante e i riflettori sono di tipo speculare a faccette curve progressive per una migliore diffusione della luce all'interno del fascio di emissione.

The Jango series is composed by small fixed and adjustable projectors, of round or square shape, with different recess depths and equipped with both on / off and phase cut dimmable driver. A complete range for the realization of lighting accents with a quality light: the high color rendering CoB LEDs CR I > 90 and SDCM < 3 enhance colors of the illuminated objects with an intense and bright light; reflectors are specular with progressive curved faces for a better diffusion of light within the emission beam angle.



- Completo di driver remoto, alimentazione 220÷240 V / 50÷60 Hz
 - Accensione On / Off, regolazione a taglio di fase IGBT - TRIAC
 - Orientabilità verticale +/-30°
 - Colore a vista bianco opaco con anello colore alluminio lucido
 - IP20
 - Led CoB 3000 K con resa cromatica CRI > 90 e MacAdam SDCM < 3
 - No UV, No IR
 - Emissioni luminose da 815 lm
 - Efficienza luminosa fino a 91 lm/W
 - Efficienza energetica A
 - Lifetime L80 / B20 – 50.000 h
 - Lenti ottiche da 40°
 - Fino a UGR < 19
 - Classe "II"
 - Temperatura ambiente di esercizio da -20°C a +45°C
 - Certificazione CE, RoHS
 - 3 anni di garanzia
-
- *Remote driver included, feeding 220÷240 V / 50÷60 Hz*
 - *Switching On / Off, Dimmable phase cut (IGBT - TRIAC)*
 - *Horizontal adjustability 350° with stop, vertical adjustability on gimble 30°*
 - *Colours visible side matt white*
 - *IP20*
 - *Led CoB 3000K; CRI > 90; MacAdam SDCM < 3*
 - *No UV, No IR*
 - *Light output 815 lm*
 - *Efficacy up to 91 lm/W*
 - *Energy Label A*
 - *Lifetime L80 / B20 – 50.000 h*
 - *Optic lens 40°*
 - *Up to UGR < 19*
 - *Class "II"*
 - *Operating from -20°C up to +45°C*
 - *Compliance CE, RoHS*
 - *3 years warranty*

Jango



Fix



Adj



Fix
UGR < 19



Adj
UGR < 19



Fix
UGR < 19



Adj
UGR < 19

Dimensioni / Dimensions

Fix



⌀53 mm.

kg 0,26

Adj

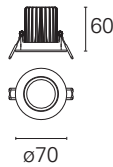

⌀60 mm.

kg 0,26

Fix / Adj
UGR < 19

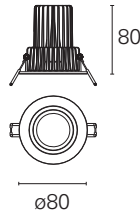

⌀70 mm.

kg 0,26

Fix / Adj
UGR < 19

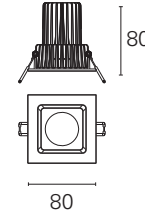

⌀75x75 mm.

kg 0,26

Ottiche / Optics

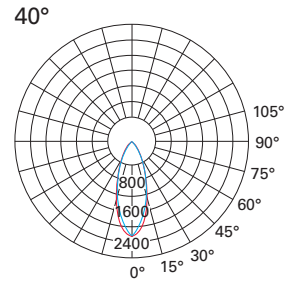

— C0-C180
— C90-C270

1	0,7	2321
2	1,4	580
3	2,1	257
4	2,8	145
5	3,6	92

h (m) d (m) E₀ (lx/klm)

Jango

CRI > 90

versione version	potenza power	ottica optic	modello model		codice code	temp. di colore light temperature	CRI CRI	MacAdam SDCM	flusso apparecchio light output	colore colour
On / Off 220 ÷ 240 V	9 W	40°	tondo rounded	fisso fixed	INC1180	3000 K	> 90	< 3	815 lm	bianco / white
				orientabile adjustable	INC1182	3000 K	> 90	< 3	815 lm	bianco / white
		40° UGR < 19	tondo rounded	fisso fixed	INC1184	3000 K	> 90	< 3	815 lm	bianco / white
				orientabile adjustable	INC1186	3000 K	> 90	< 3	815 lm	bianco / white
			quadrato squared	fisso fixed	INC1190	3000 K	> 90	< 3	815 lm	bianco / white
				orientabile adjustable	INC1192	3000 K	> 90	< 3	815 lm	bianco / white
Dimmerabile phase cut IGBT - TRIAC 220 ÷ 240 V	9 W	40°	tondo rounded	fisso fixed	INC1180D	3000 K	> 90	< 3	815 lm	bianco / white
				orientabile adjustable	INC1182D	3000 K	> 90	< 3	815 lm	bianco / white
		40° UGR < 19	tondo rounded	fisso fixed deep	INC1184D	3000 K	> 90	< 3	815 lm	bianco / white
				orientabile adjustable deep	INC1186D	3000 K	> 90	< 3	815 lm	bianco / white
			quadrato squared	fisso fixed	INC1190D	3000 K	> 90	< 3	815 lm	bianco / white
				orientabile adjustable	INC1192D	3000 K	> 90	< 3	815 lm	bianco / white

Show IP65



☐ IP65 ^{UP TO} 93 lm/W L80 / B20 50.000h. CRI > 90 SDCM < 3 3 YEARS WARRANTY

Show è un incassato professionale di dimensioni ridotte equipaggiato con led CoB ad alta qualità cromatica, con valori di CRI > 90 e SDCM < 3. Impermeabile all'acqua e alla polvere, Show si distingue per il suo grado IP65, che lo rende adatto ad essere installato anche in ambienti dove è richiesta una particolare attenzione alla protezione degli apparecchi e alla loro pulizia. Grazie a questa caratteristica Show mantiene più facilmente nel tempo le performance luminose date dal led e dall'ottica speculare che lo equipaggia.

Professional recessed product of small size equipped with high quality chromatic CoB LEDs, with CRI > 90 and SDCM < 3 values. Water and dustproof, Show stands out for its IP65 rating, which makes it suitable for installation even in areas where special attention as for protection and cleaning of lighting fixtures is required.



- Completo di driver remoto, alimentazione 220÷240 V / 50÷60 Hz
- Accensione On / Off
- Colore a vista bianco opaco
- IP65 vano ottico; IP65 vano incasso; IP65 driver
- Led CoB 3000 K con resa cromatica CRI > 90 e MacAdam SDCM < 3
- No UV, No IR
- Emissioni luminose da 1400 lm
- Efficienza luminosa fino a 93 lm/W
- Efficienza energetica A
- Lifetime L80 / B20 – 50.000 h.
- Lenti ottiche da 40°
- Classe "II"
- Temperatura ambiente di esercizio da -20°C a +45°C
- Certificazione CE, RoHS
- 3 anni di garanzia

- *Remote driver included, feeding 220÷240 V / 50÷60 Hz*
- *Switching On / Off*
- *Colours visible side matt white*
- *IP65 up; IP65 down; IP65 driver*
- *Led CoB 3000K; CRI > 90; MacAdam SDCM < 3*
- *No UV, No IR*
- *Light output 1400 lm*
- *Efficacy up to 93 lm/W*
- *Energy Label A*
- *Lifetime L80 / B20 – 50.000 h.*
- *Optic lens 40°*
- *Class "II"*
- *Operating from -20°C up to +45°C*
- *Compliance CE, RoHS*
- *3 years warranty*

Show IP65



Dimensioni / Dimensions

9 W

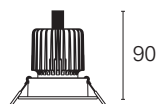

90



ø90

kg 0,23

⊕ ø75 mm.

15 W



110



ø90

kg 0,29

⊕ ø75 mm.

Ottiche / Optics

40°

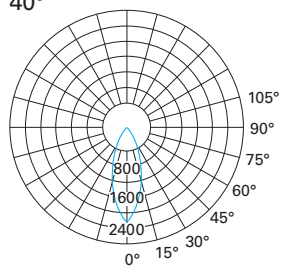

— C0-C180
— C90-C270

1	0,7	2321
2	1,4	580
3	2,1	257
4	2,8	145
5	3,6	92

h (m) d (m) E₀ (lx/klm)

Show

CRI > 90

versione version	potenza power	ottica optic	codice code	temp. di colore light temperature	CRI CRI	MacAdam SDCM	flusso apparecchio light output	colore colour
On / Off	9 W	40°	INC1043	3000 K	> 90	< 3	815 lm	bianco / white
220 ÷ 240 V	15 W	40°	INC1044	3000 K	> 90	< 3	1426 lm	bianco / white

Shop



 UP TO 93 lm/W L80 / B20 50.000 h. CRI > 90 SDCM < 3 3 YEARS WARRANTY

La serie di proiettori Shop è composta da moduli ottici di tipo “gimble” progettati per l’illuminazione dei negozi e montati su apposite piastre modulari. Le piastre, quadrate o rettangolari, possono essere equipaggiate con uno, due, tre proiettori fra loro orientabili in modo indipendente. Questa soluzione permette di raggruppare in un unico punto luce e in un unico taglio del controsoffitto più sorgenti luminose indipendenti risparmiando sui costi di installazione senza rinunciare alla versatilità dei puntamenti. Le qualità cromatiche dei led utilizzati sono CRI > 90 e SDCM < 3 e le mollette di fissaggio permettono un’installazione senza utensili.

The Shop series consisting of a range of gimble projectors specifically designed for shop lighting and mounted on metallic modular plates. The plates, squared or rectangular, can be equipped with one, two or three projectors that can be oriented independently among them. This solution allows to group in a single light and in a single cut of the false ceiling more independent light sources saving on installation costs without renouncing the versatility of the system. The chromatic qualities of the LEDs used are CRI > 90 and SDCM < 3 and the fixing clips allow installation without tools.



- Completi di driver remoti, alimentazione 220÷240 V / 50÷60 Hz
- Installabile in controsoffitto con apposite piastre in dotazione
- Alimentazioni: On / Off, Dimmerabile Multifunzione (Push / 1...10 V), DALI.
- Versioni con controllo digitale "Casambi" o "Pan Digital System"
- Kit emergenza 1h / 3h. accessorio remoto.
- Orientabilità orizzontale 350° con stop di rotazione, verticale +/-30°
- Colore a vista bianco opaco
- IP40 vano ottico; IP20 vano incassato
- Led CoB 3000 K / 4000 K con resa cromatica CRI > 90 e MacAdam SDCM < 3
- No UV, No IR
- Emissioni luminose da 1424 lm a 3x 1424 lumen
- Efficienza luminosa fino a 94 lm/W
- Efficienza energetica A
- Lifetime L80 / B20 – 50.000 h.
- Lenti ottiche da 40°
- Classe "II"
- Temperatura ambiente di esercizio da -20°C a +45°C
- Certificazione CE, RoHS
- 3 anni di garanzia

- *Remote driver included, feeding 220÷240 V / 50÷60 Hz*
- *Mounted on plate included*
- *Switching: On / Off, Multifunction Dimmable (Push / 1... 10 V), DALI.*
- *Digital Control Versions "Casambi" or "Pan Digital System"*
- *Emergency Kit 1h / 3h as remote accessory.*
- *Horizontal adjustability 350° with stop, vertical adjustability on gimble +/-30°*
- *Colours visible side matt white*
- *IP40 down; IP20 up*
- *Led CoB 3000 K / 4000 K; CRI > 90; MacAdam SDCM < 3*
- *No UV, No IR*
- *Light output from 1424 lm up to 3x 1424 lm*
- *Efficacy up to 94 lm/W*
- *Energy Label A*
- *Lifetime L80 / B20 – 50.000 h.*
- *Optic lens 40°*
- *Class "II"*
- *Operating from -20°C up to +45°C*
- *Compliance CE, RoHS*
- *3 years warranty*

Shop



Dimensioni / Dimensions

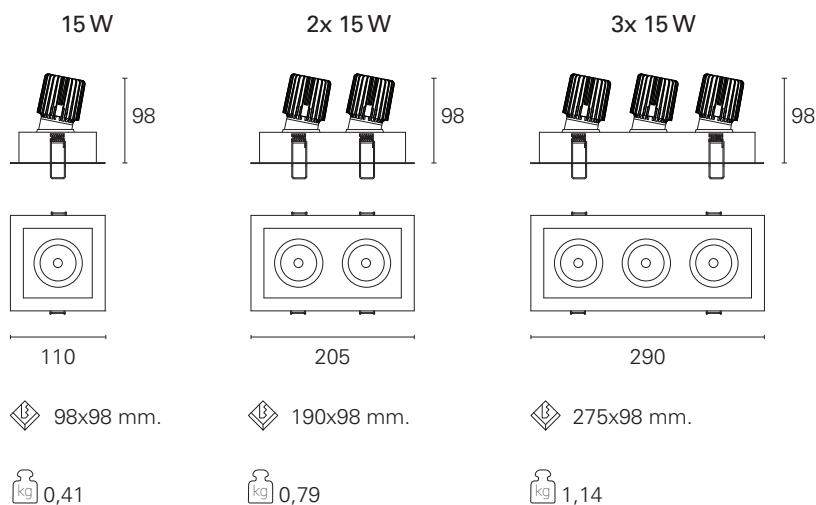

Ottiche / Optics

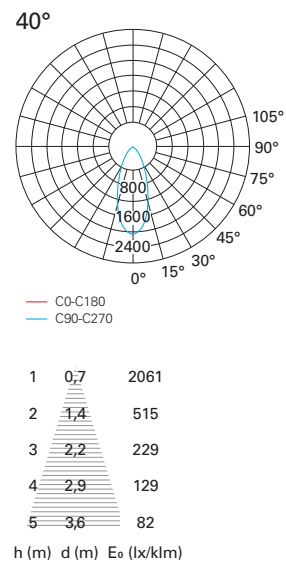

Shop

CRI > 90

versione version	potenza power	ottica optic	codice code	temp. di colore light temperature	CRI CRI	MacAdam SDCM	flusso apparecchio light output	colore colour
On / Off 220 ÷ 240 V	15 W	40°	INC1325	3000 K	> 90	< 3	1424 lm	bianco / white
			INC1345	4000 K	> 90	< 3	1490 lm	bianco / white
	2x 15 W	40°	INC1326	3000 K	> 90	< 3	2848 lm	bianco / white
			INC1346	4000 K	> 90	< 3	2980 lm	bianco / white
	3x 15 W	40°	INC1327	3000 K	> 90	< 3	4272 lm	bianco / white
			INC1347	4000 K	> 90	< 3	4470 lm	bianco / white

Versioni dimmerabili / Dimmable versions

con regolazione via cavo
wired dimmable

versioni version	suffisso codice code suffix	nota note	esempio example
1...10 V	D	per ordinare la versione 1...10 V aggiungere D alla fine del codice to order the 1...10 V version add D to the end of the code	RTL-----D
DALI	DA	per ordinare la versione DALI aggiungere DA alla fine del codice to order the DALI version add DA to the end of the code	RTL-----DA

Kit Emergenza / Emergency Kit

autonomia operation time	tempo di accensione switching time	tempo di ricarica recharging time	foro di incasso minimo (*) minimum recessing hole (*)	IP IP	peso weight	codice code
1 ora / 1 hour	0,5 sec.	24 h.	Ø 75 mm.	IP20	0,43 kg	DRV9092
3 ora / 3 hour	0,5 sec.	24 h.	Ø 100mm.	IP20	0,88 kg	DRV9091

(*) per l'installazione in controsoffitto verificare la compatibilità con il foro di incasso; vedi dettagli a pagina 546
(* for installation in false ceiling check the compatibility with the recessing hole; see details to page 546)

Single

□ 220÷240 V GU10

Apparecchio da incasso. Corpo in alluminio. Versioni fisse e orientabili. Completo di portalampada GU10.
Per effetti di luce concentrata. Lampada non inclusa.

*Recessed aluminium body. Fixed and adjustable versions. With GU10 lampholder. For concentrated light effect.
Bulb not included.*



Dimensioni / Dimensions

Fixed Downlight

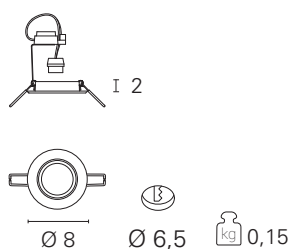

Adjustable Downlight

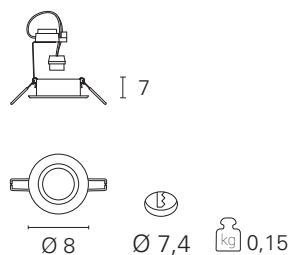

Single

Versione Model	Codice Code	Colore Finishing	Potenza / Flusso Effettivo Power / Lumen Output	Sorgente Source	Alimentazione Power feeding	Classe energetica Energy Label	IP IP
Fixed Downlight	INC00038	Nero / Black	max. 50 W (not included)	LED / HAGS GU10	220÷240 V - class II	A++...D	IP20
Fixed Downlight	INC00041	Bianco / White	max. 50 W (not included)	LED / HAGS GU10	220÷240 V - class II	A++...D	IP20
Fixed Downlight	INC00044	Nichel / Nickel	max. 50 W (not included)	LED / HAGS GU10	220÷240 V - class II	A++...D	IP20
Adjustable Downlight	INC00050	Bianco / White	max. 50 W (not included)	LED / HAGS GU10	220÷240 V - class II	A++...D	IP20
Adjustable Downlight	INC00053	Nichel / Nickel	max. 50 W (not included)	LED / HAGS GU10	220÷240 V - class II	A++...D	IP20

Turn

□ 220÷240 V GU10

Apparecchio da incasso. Corpo in alluminio. Versioni fisse e orientabili. Completo di portalampada GU10. Per effetti di luce concentrata. Lampada non inclusa.

Recessed aluminium body. Fixed and adjustable versions. With GU10 lampholder. For concentrated light effect. Bulb not included.



INC00015



INC00025



INC00035



INC00002



INC00005



INC00007

Dimensioni / Dimensions

INC00002
INC00015



INC00005
INC00025

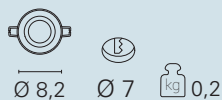

INC00007
INC00035

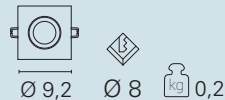

Turn

Versione Model	Codice Code	Colore Finishing	Potenza / Flusso Effettivo Power / Lumen Output	Sorgente Source	Alimentazione Power feeding	Classe energetica Energy Label	IP IP
Fixed Downlight - Rounded	INC00002	Alluminio / Aluminum	max. 50 W (not included)	LED / HAGS GU10	220÷240 V - class II	A++...D	IP20
Adjustable Downlight - Rounded	INC00005	Alluminio / Aluminum	max. 50 W (not included)	LED / HAGS GU10	220÷240 V - class II	A++...D	IP20
Adjustable Downlight - Squared	INC00007	Alluminio / Aluminum	max. 50 W (not included)	LED / HAGS GU10	220÷240 V - class II	A++...D	IP20
Fixed Downlight - Rounded	INC000015	Bianco / White	max. 50 W (not included)	LED / HAGS GU10	220÷240 V - class II	A++...D	IP20
Adjustable Downlight - Rounded	INC000025	Bianco / White	max. 50 W (not included)	LED / HAGS GU10	220÷240 V - class II	A++...D	IP20
Adjustable Downlight - Squared	INC000035	Bianco / White	max. 50 W (not included)	LED / HAGS GU10	220÷240 V - class II	A++...D	IP20

Focus



□ 220÷240 V Power Led IP20 / IP40

Piccoli e performanti, i minispot della serie Focus creano precisi accenti di luce senza abbagliamento grazie alla posizione arretrata della sorgente led. Nelle versioni fisse e orientabili, i minispot Focus emettono luce brillante all'interno di un fascio nitido e senza sbavature con solo 4,5 W di assorbimento di energia elettrica. I led selezionati fra le prime labels e il corpo interamente realizzato in pressofusione di alluminio assicurano sia una lunga vita alla sorgente led sia la costanza delle sue caratteristiche colorimetriche nel tempo (L80B20 a 50.000 ore). Focus è disponibile in finitura bianco opaca e nero opaca e viene fornito con alimentatore precablato.

Small and performing, the Focus series of recessed minispots create precise accents of light without glare thanks to the backward position of the LED source. In the fixed and adjustable versions, the Focus minispots emit bright light within a sharp and smudge-free beam with only 4.5 W of electricity absorption. The LEDs selected from the first labels and the body entirely made of die-cast aluminum ensure both a long life to the LED source and the constancy of its colorimetric characteristics over time (L80 / B20 at 50,000 hours). Focus is available in a matt white and matt black finish and complete of wired driver.



Focus



Fisso - Fixed



Orientabile - Adjustable

Dimensioni / Dimensions

Rounded Fix

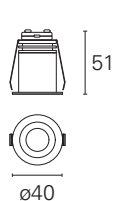

Ⓢ ⌀35 mm.

Ⓚ 0,10

Rounded Adj

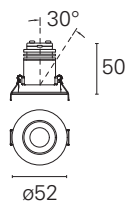

Ⓢ ⌀45 mm.

Ⓚ 0,10

Squared Adj

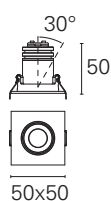

Ⓢ ⌀45 mm.

Ⓚ 0,10

completo di driver precablato 700 mA DC
complete of wired driver 700 mA DC

Ottiche / Optics

20° 40000 K

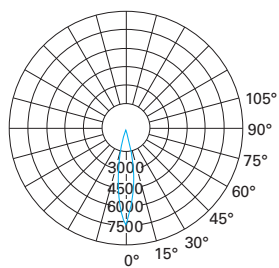

— C0-C180
— C90-C270

h (m)	d (m)	E ₀ (lx/klm)
1	0,3	1531
1,5	0,4	681
2	0,6	383
2,5	0,7	245
3	0,9	170

38° 40000 K

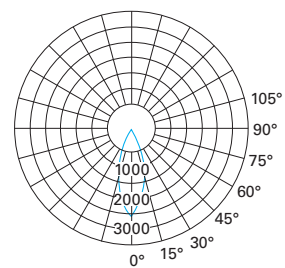

— C0-C180
— C90-C270

h (m)	d (m)	E ₀ (lx/klm)
1	0,6	564
1,5	0,9	251
2	1,3	141
2,5	1,6	90
3	1,9	63



Fisso - Fixed



Orientabile - Adjustable



Focus

CRI > 80

Fisso - Fixed

versione version	potenza power	figura design	ottica optic	codice code	CCT CCT	flusso apparecchio light output	IP IP	colore colour
On / Off 220 ÷ 240 V	4,5 W	rounded	20°	RTL34111	3000 K	195 lm	IP40	bianco / white
				RTB34111	3000 K	195 lm	IP40	nero / black
				RTL34112	4000 K	215 lm	IP40	bianco / white
				RTB34112	4000 K	215 lm	IP40	nero / black
			38°	RTL34113	3000 K	200 lm	IP40	bianco / white
				RTB34113	3000 K	200 lm	IP40	nero / black
				RTL34114	4000 K	220 lm	IP40	bianco / white
				RTB34114	4000 K	220 lm	IP40	nero / black

Orientabile - Adjustable

On / Off 220 ÷ 240 V	4,5 W	rounded	20°	RTL34211	3000 K	195 lm	IP20	bianco / white
				RTB34211	3000 K	195 lm	IP20	nero / black
				RTL34212	4000 K	215 lm	IP20	bianco / white
				RTB34212	4000 K	215 lm	IP20	nero / black
			38°	RTL34213	3000 K	200 lm	IP20	bianco / white
				RTB34213	3000 K	200 lm	IP20	nero / black
				RTL34214	4000 K	220 lm	IP20	bianco / white
				RTB34214	4000 K	220 lm	IP20	nero / black
		squared	20°	RTL34215	3000 K	195 lm	IP20	bianco / white
				RTB34215	3000 K	195 lm	IP20	nero / black
				RTL34216	4000 K	215 lm	IP20	bianco / white
				RTB34216	4000 K	215 lm	IP20	nero / black
			38°	RTL34217	3000 K	200 lm	IP20	bianco / white
				RTB34217	3000 K	200 lm	IP20	nero / black
				RTL34218	4000 K	220 lm	IP20	bianco / white
				RTB34218	4000 K	220 lm	IP20	nero / black

Driver incluso / Driver included

Pill

◆ 700 mA Power Led IP40

Apparecchio orientabile da incasso per interni realizzato in alluminio anodizzato nero con sistema di fissaggio tramite molle in acciaio. Tre ottiche secondarie (lenti) e due temperature colore disponibili. Data l'altezza ridottissima e le dimensioni contenute è ideale, oltre che per illuminazione di teche e nicchie, per l'installazione in mensole ed ovunque siano richiesti spessori ridotti.

Adjustable recessed luminaire for indoor installation. Black anodized aluminum body and steel springs fixing system. Three secondary optics (lenses) and two colour temperature available. Thanks to small height and the small dimensions it is ideal for lighting of display cases and niches, as well as for installation in shelves and everywhere it's required reduced thickness.



Dimensioni / Dimensions

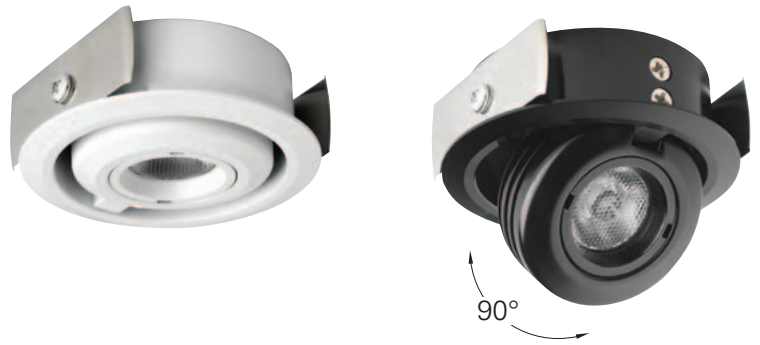
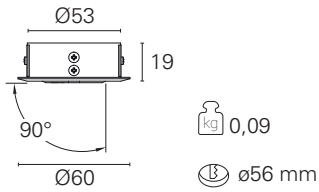

Ottiche / Optics

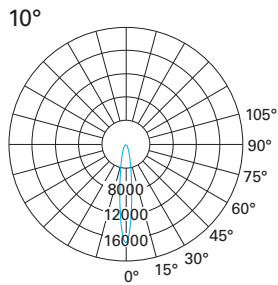

— C0-C180
— C90-C270

1	0,17	17376
1.5	0,26	7723
2	0,34	4344
2.5	0,43	2780
3	0,51	1930

h (m) d (m) E₀ (lx/klm)

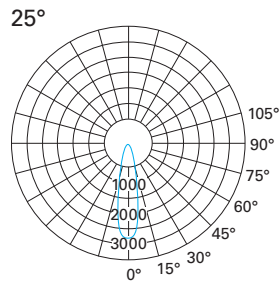

— C0-C180
— C90-C270

1	0,41	2865
1.5	0,62	1273
2	0,83	716
2.5	1,04	458
3	1,24	318

h (m) d (m) E₀ (lx/klm)

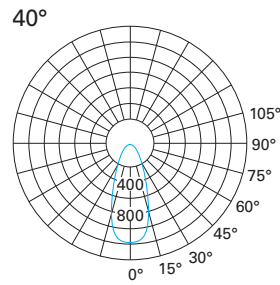

— C0-C180
— C90-C270

1	0,7	1188
1.5	1	528
2	1,4	297
2.5	1,7	190
3	2,1	132

h (m) d (m) E₀ (lx/klm)

Pill

potenza power	dimensioni size	codice code	temp. di colore light temperature	CRI CRI	flusso apparecchio light output	ottica optic	colore colour
2,5W 700 mA	Tondo / Rounded Ø 60 mm. x h. 19 mm.	RTL48101	3000 K	> 80	270 lm	10°	bianco / white
		RTL48102	3000 K	> 80	270 lm	25°	bianco / white
		RTL48103	3000 K	> 80	270 lm	40°	bianco / white
		RTL48107	3000 K	> 80	270 lm	10°	nero / black
		RTL48108	3000 K	> 80	270 lm	25°	nero / black
		RTL48109	3000 K	> 80	270 lm	40°	nero / black
		RTL48104	4000 K	> 80	290 lm	10°	bianco / white
		RTL48105	4000 K	> 80	290 lm	25°	bianco / white
		RTL48106	4000 K	> 80	290 lm	40°	bianco / white
		RTL48110	4000 K	> 80	290 lm	10°	nero / black
		RTL48111	4000 K	> 80	290 lm	25°	nero / black
		RTL48112	4000 K	> 80	290 lm	40°	nero / black

Driver non incluso; circuito in serie (max 5 apparecchi) - Driver not included; serial circuit (max 5 fixtures)

Alimentazioni / Feeding



L'alimentatore non passa attraverso foro di incasso dell'apparecchio. Prevedere il suo posizionamento in altro luogo

The driver does not pass through the hole of installation in the false ceiling. Consider its placement elsewhere

on-off

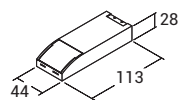

n° 1...5 pz / pcs

codice code	DRV1005
potenza power	max 20 W
tensione in uscita output voltage	2 ÷ 29V DC
tensione in ingr. voltage range	220÷240 V - 50 / 60 Hz
cl. isolamento / IP insulation class / IP	class II / IP20

Phase cut
IGBT / TRIAC

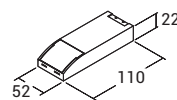

n° 2...5 pz / pcs

codice code	DRV1035
potenza power	max 20 W
tensione in uscita output voltage	5 ÷ 29V DC
tensione in ingr. voltage range	220÷240 V - 50 / 60 Hz
cl. isolamento / IP insulation class / IP	class II / IP20

PUSH
0/1...10 V

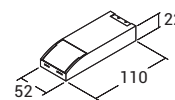

n° 1...5 pz / pcs

codice code	DRV1014
potenza power	max 20 W
tensione in uscita output voltage	2 ÷ 29V DC
tensione in ingr. voltage range	220÷240 V - 50 / 60 Hz
cl. isolamento / IP insulation class / IP	class II / IP20

DALI

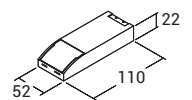

n° 1...5 pz / pcs

codice code	DRV1030
potenza power	max 20 W
tensione in uscita output voltage	2 ÷ 28V DC
tensione in ingr. voltage range	220÷240 V - 50 / 60 Hz
cl. isolamento / IP insulation class / IP	class II / IP20

Microled / Miniled

Incassato calpestabile e stagno per interni ed esterni realizzato in alluminio con ghiera frontale in acciaio AISI 316. Versione Microled con vetro di protezione leggermente satinato. È fornito completo di kit d'installazione per fissaggio con molla in acciaio su pannelli e cassaforma PBT per muratura.

To be encased in floors and is watertight. It can be used both indoors and outdoors. Made in aluminium with front AISI 316 steel ring. Microled models complete of protection glass with a slightly satin finish. It comes with an installation kit that includes steel spring on panels and PBT formwork for brickwork installations.





Microled

III 350 mA Power Led IP67

IP67



Bianco
White



Acciaio
Stainless steel

Ottiche / Optics

Microled

120°

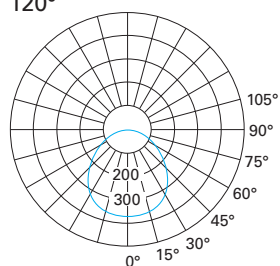

h (m)	d (m)	E ₀ (lx/klm)
1	2,7	371
1.5	4,1	165
2	5,4	93
2.5	6,8	59
3	8,1	41

— C0-C180
— C90-C270



Dimensioni / Dimensions

Microled Rounded - 1 W

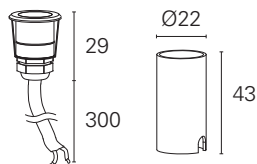

Microled

IP67

potenza power	dimensioni size	codice code	temp. di colore light temperature	CRI CRI	flusso apparecchio light output	ottica optic	colore colour
1W 350mA	Tondo / <i>Rounded</i> Ø 23 mm. x h. 29 mm.	EST58121	3000 K	> 80	95 lm	120°	acciaio / <i>stainless steel</i>
		EST58120	4000 K	> 80	105 lm	120°	acciaio / <i>stainless steel</i>
		EST58123	3000 K	> 80	95 lm	120°	bianco / <i>white</i>
		EST58122	4000 K	> 80	105 lm	120°	bianco / <i>white</i>

Driver non incluso; circuito in serie (max 5 apparecchi) - Driver not included; serial circuit (max 5 fixtures)

Alimentazioni / Feeding



L'alimentatore non passa attraverso il foro di incasso dell'apparecchio. Prevedere il suo posizionamento in altro luogo

The driver does not pass through the hole of installation in the false ceiling. Consider its placement elsewhere

on-off

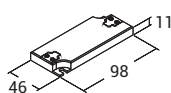

n° 1...3 pz / pcs

codice code	DRV1008
potenza power	max 6 W
tensione in uscita output voltage	2 ÷ 18V DC
tensione in ingr. voltage range	220÷240 V - 50 / 60 Hz
cl. isolamento / IP insulation class / IP	class II / IP20

on-off

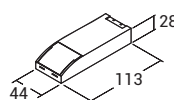

n° 3...5 pz / pcs

codice code	DRV1004
potenza power	max 12 W
tensione in uscita output voltage	2 ÷ 32V DC
tensione in ingr. voltage range	220÷240 V - 50 / 60 Hz
cl. isolamento / IP insulation class / IP	class II / IP20

on-off IP67

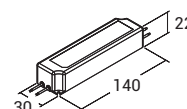

n° 2...5 pz / pcs

codice code	DRV1050
potenza power	max 16,8 W
tensione in uscita output voltage	6 ÷ 48V DC
tensione in ingr. voltage range	220÷240 V - 50 / 60 Hz
cl. isolamento / IP insulation class / IP	class II / IP67

Phase cut
IGBT / TRIAC

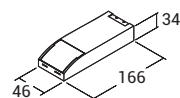

n° 1...5 pz / pcs

codice code	DRV1012
potenza power	max 17 W
tensione in uscita output voltage	2 ÷ 47V DC
tensione in ingr. voltage range	220÷240 V - 50 / 60 Hz
cl. isolamento / IP insulation class / IP	class II / IP20

PUSH
0/1...10 V

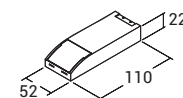

n° 1...5 pz / pcs

codice code	DRV1014
potenza power	max 15 W
tensione in uscita output voltage	2 ÷ 43V DC
tensione in ingr. voltage range	220÷240 V - 50 / 60 Hz
cl. isolamento / IP insulation class / IP	class II / IP20

DALI

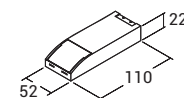

n° 1...5 pz / pcs

codice code	DRV1030
potenza power	max 15 W
tensione in uscita output voltage	2 ÷ 43V DC
tensione in ingr. voltage range	220÷240 V - 50 / 60 Hz
cl. isolamento / IP insulation class / IP	class II / IP20

Miniled

III 500 mA Power Led IP67



Bianco
White



Acciaio
Stainless steel



Acciaio
Stainless steel

Ottiche / Optics

Miniled

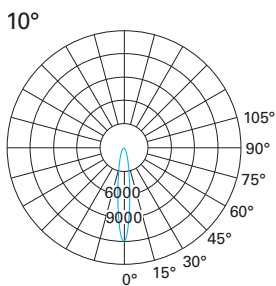

— C0-C180
— C90-C270

1	0,18	12331
1.5	0,27	5480
2	0,36	3083
2.5	0,45	1973
3	0,54	1370
h (m)	d (m)	E ₀ (lx/klm)

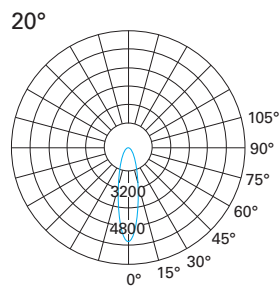

— C0-C180
— C90-C270

1	0,31	6036
1.5	0,46	2683
2	0,61	1509
2.5	0,77	966
3	0,92	671
h (m)	d (m)	E ₀ (lx/klm)

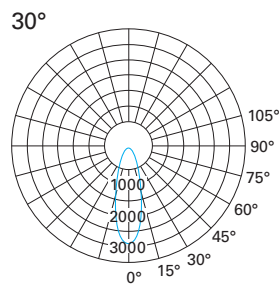

— C0-C180
— C90-C270

1	0,5	2923
1.5	0,75	1299
2	1	731
2.5	1,3	468
3	1,5	325
h (m)	d (m)	E ₀ (lx/klm)



Dimensioni / Dimensions

Miniled Rounded - 2W

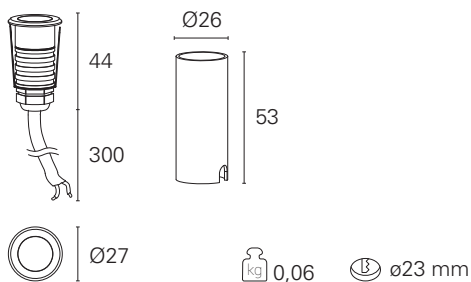

Miniled Squared - 2W

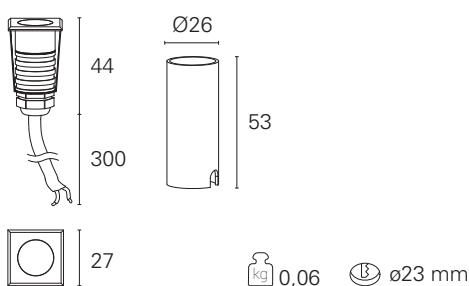

Miniled

IP67

potenza power	dimensioni size	codice code	temp. di colore light temperature	CRI CRI	flusso apparecchio light output	ottica optic	colore colour
2W 500mA	Tondo / <i>Rounded</i> Ø 27 mm. x h. 44 mm.	EST58100	4000 K	> 80	210 lm	10°	acciaio / <i>stainless steel</i>
		EST58101	4000 K	> 80	210 lm	20°	acciaio / <i>stainless steel</i>
		EST58102	4000 K	> 80	210 lm	30°	acciaio / <i>stainless steel</i>
		EST58103	3000 K	> 80	190 lm	10°	acciaio / <i>stainless steel</i>
		EST58104	3000 K	> 80	190 lm	20°	acciaio / <i>stainless steel</i>
		EST58105	3000 K	> 80	190 lm	30°	acciaio / <i>stainless steel</i>
		EST58133	3000 K	> 80	190 lm	10°	bianco / <i>white</i>
		EST58134	3000 K	> 80	190 lm	20°	bianco / <i>white</i>
		EST58135	3000 K	> 80	190 lm	30°	bianco / <i>white</i>
		EST58130	4000 K	> 80	210 lm	10°	bianco / <i>white</i>
		EST58131	4000 K	> 80	210 lm	20°	bianco / <i>white</i>
		EST58132	4000 K	> 80	210 lm	30°	bianco / <i>white</i>
2W 500mA	Quadrato / <i>Squared</i> 27 x 27 x 44 mm.	EST58113	3000 K	> 80	190 lm	10°	acciaio / <i>stainless steel</i>
		EST58114	3000 K	> 80	190 lm	20°	acciaio / <i>stainless steel</i>
		EST58115	3000 K	> 80	190 lm	30°	acciaio / <i>stainless steel</i>

Driver non incluso; circuito in serie (max 5 apparecchi) - *Driver not included; serial circuit (max 5 fixtures)*

Alimentazioni / Feeding



L'alimentatore non passa attraverso foro di incasso dell'apparecchio. Prevedere il suo posizionamento in altro luogo

The driver does not pass through the hole of installation in the false ceiling. Consider its placement elsewhere

on-off

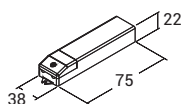

n° 1...3 pz / pcs

codice code	DRV1020
potenza power	max 8 W
tensione in uscita output voltage	3 ÷ 15V DC
tensione in ingr. voltage range	220÷240 V - 50 / 60 Hz
cl. isolamento / IP insulation class / IP	class II / IP20

on-off

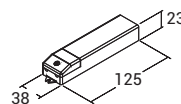

n° 3...5 pz / pcs

codice code	DRV1021
potenza power	max 16,8 W
tensione in uscita output voltage	3 ÷ 33V DC
tensione in ingr. voltage range	220÷240 V - 50 / 60 Hz
cl. isolamento / IP insulation class / IP	class II / IP20

on-off IP67

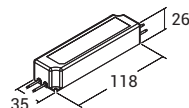

n° 1...5 pz / pcs

codice code	DRV1023
potenza power	max 17,5 W
tensione in uscita output voltage	9 ÷ 35V DC
tensione in ingr. voltage range	220÷240 V - 50 / 60 Hz
cl. isolamento / IP insulation class / IP	class II / IP67

Phase cut
IGBT / TRIAC

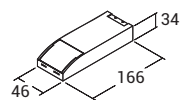

n° 1...5 pz / pcs

codice code	DRV1012
potenza power	max 24 W
tensione in uscita output voltage	2 ÷ 47V DC
tensione in ingr. voltage range	220÷240 V - 50 / 60 Hz
cl. isolamento / IP insulation class / IP	class II / IP20

PUSH
0/1...10 V

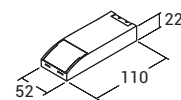

n° 1...5 pz / pcs

codice code	DRV1014
potenza power	max 20 W
tensione in uscita output voltage	2 ÷ 40V DC
tensione in ingr. voltage range	220÷240 V - 50 / 60 Hz
cl. isolamento / IP insulation class / IP	class II / IP20

DALI

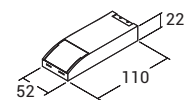

n° 1...5 pz / pcs

codice code	DRV1030
potenza power	max 20 W
tensione in uscita output voltage	2 ÷ 40V DC
tensione in ingr. voltage range	220÷240 V - 50 / 60 Hz
cl. isolamento / IP insulation class / IP	class II / IP20

Odino / Song

Gesso
Plaster



☐ GU10 / Power Led

Apparecchio da incasso. Corpo in gesso liscio bianco. Versioni a LED integrato e GU10. Versione a LED completa di alimentatore. Versione GU10 completa di portalamпада (Lampada non inclusa). Per effetti di luce di accento. Lampada non inclusa.

Recessed. White polished plaster body.. LED version and GU10 version. LED version driver included. GU10 version with lampholder. (Bulb not included). For accent light effects.



Odino



Song

Dimensioni / Dimensions

Odino

Downlight Led

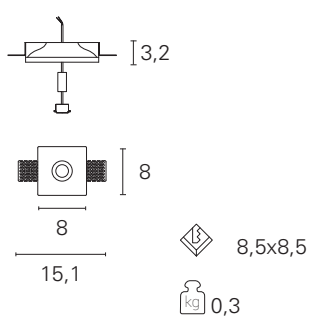

Downlight GU10

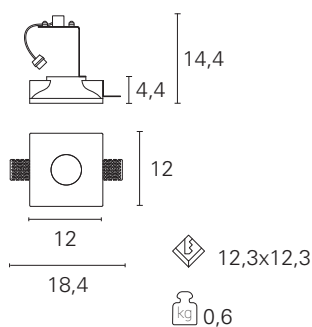

Song

Downlight Led

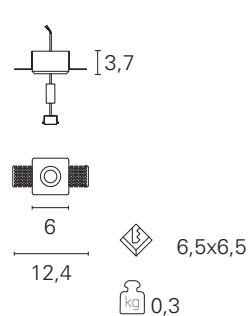

Downlight GU10

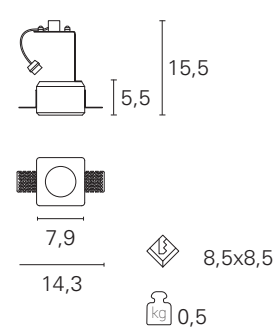

Odino

Versione Model	Codice Code	Colore Finishing	Potenza / Flusso Effettivo Power / Lumen Output	CCT CCT	Sorgente Source	Alimentazione Power feeding	Classe energetica Energy Label	IP
Downlight - Led	INC10518	Bianco / White	3 W / 170 lm	3000 K	Power LED	220÷240 V - class II	LED	IP20
Downlight - GU10	INC10531	Bianco / White	not included	\	LED / HAGS GU10	220÷240 V - class II	A++...D	IP20

Versioni Power Led complete di driver / Power Led models with driver included

Song

Versione Model	Codice Code	Colore Finishing	Potenza / Flusso Effettivo Power / Lumen Output	CCT CCT	Sorgente Source	Alimentazione Power feeding	Classe energetica Energy Label	IP
Downlight - Led	INC10519	Bianco / White	3 W / 170 lm	3000 K	Power LED	220÷240 V - class II	LED	IP20
Downlight - GU10	INC10535	Bianco / White	not included	\	LED / HAGS GU10	220÷240 V - class II	A++...D	IP20

Versioni Power Led complete di driver / Power Led models with driver included

Ricambi / Spare Parts

Tutti gli apparecchi delle famiglie Odino e Song vengono forniti con staffa portalamada inclusa.
All fixtures of the Odino and Song families are supplied with a lamp holder bracket included



Ricambio Spare part	Codice Code	Attacco Attack
Staffa/Socket	INC1507	GU10

Ettore / Enea

Gesso
Plaster



□ 220÷240 V GU10

Apparecchio da incasso. Corpo in gesso liscio bianco. Schermo diffondente per il controllo dell'abbagliamento diretto. Completo di portalampada GU10. Per effetti di luce di accento. Lampada non inclusa.

Recessed. White polished plaster body. Diffusing screen for direct glare control. With GU10 lampholder. For accent light effects. Bulb not included.



Ettore



Enea

Dimensioni / Dimensions

Ettore

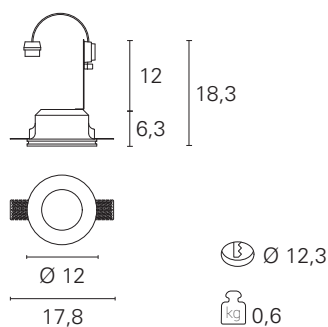

Enea

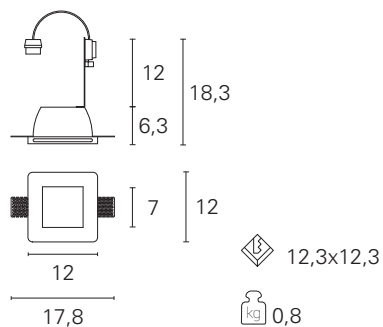

Ettore

Versione Model	Codice Code	Colore Finishing	Potenza / Flusso Effettivo Power / Lumen Output	CCT CCT	Sorgente Source	Alimentazione Power feeding	Classe energetica Energy Label	IP
Downlight	INC10020	Bianco / White	max. 35 W (not included)	\	LED / HAGS GU10	220÷240 V - class II	A++...D	IP20

Enea

Versione Model	Codice Code	Colore Finishing	Potenza / Flusso Effettivo Power / Lumen Output	CCT CCT	Sorgente Source	Alimentazione Power feeding	Classe energetica Energy Label	IP
Downlight	INC10010	Bianco / White	max. 35 W (not included)	\	LED / HAGS GU10	220÷240 V - class II	A++...D	IP20

Priamo

Gesso
Plaster



□ 220÷240 V GU10

Apparecchio da incasso. Corpo in gesso liscio bianco. Per installazione trimless. Completo di portalampana GU10. Per effetti di luce concentrata. Sorgente GU10 non inclusa.

Recessed. White polished plaster body. Trimless mounting. With GU10 lampholder. For concentrated light effect. GU10 bulb not included.



Priamo

Dimensioni / Dimensions

Priamo 1x Spot

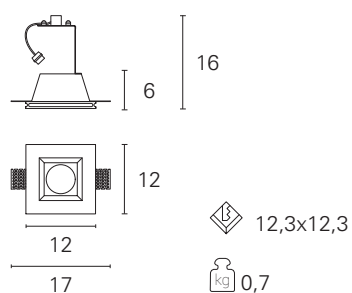

Priamo 2x Spots

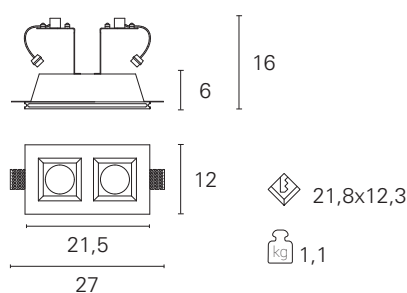

Priamo

Versione Model	Codice Code	Colore Finishing	Potenza / Flusso Effettivo Power / Lumen Output	CCT CCT	Sorgente Source	Alimentazione Power feeding	Classe energetica Energy Label	IP
Downlight - 1x Spot	INC1501	Bianco / White	max. 35 W (not included)	\	LED / HAGS GU10	220÷240 V - class II	A++...D	IP20
Downlight - 2x Spots	INC1503	Bianco / White	max. 2x 35 W (not included)	\	LED / HAGS GU10	220÷240 V - class II	A++...D	IP20

Ricambi / Spare Parts

Tutti gli apparecchi delle famiglie Ettore, Enea, Priamo e Paride sono forniti con staffa porta lampada inclusa
All fixtures of the Ettore, Enea, Priamo e Paride families are supplied with a lamp holder bracket included



Ricambio Spare part	Codice Code	Attacco Attack
Staffa/Socket	INC1507	GU10

Paride

Gesso
Plaster



□ 220÷240 V GU10

Apparecchio da incasso a soffitto ed a parete. Versione a soffitto per effetti di luce spot; versioni a parete con emissione asimmetrica per l'illuminazione radente del pavimento. Corpo in gesso liscio bianco per installazione trimless. Completati di portalampada GU10. Sorgente GU10 non inclusa.

Wall or ceiling recessed luminaire. Ceiling mounted version for spot lighting effect. Wall mounted version with asymmetric light emission for grazing light effect on the floor. White polished plaster body. Trimless mounting. With GU10 lampholder. GU10 bulb not included.



Dimensioni / Dimensions

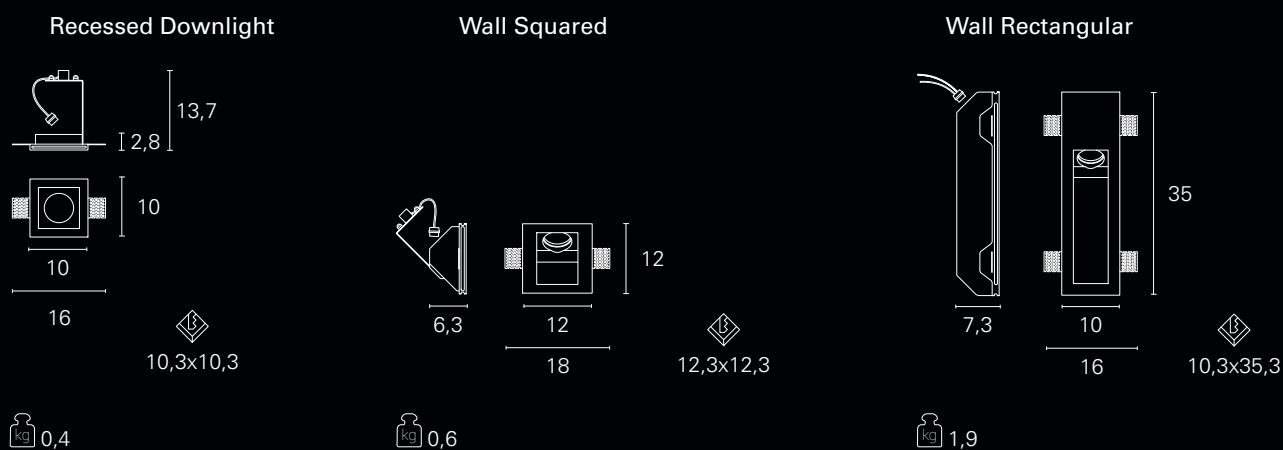



INC1502



INC1515

Paride

Versione Model	Codice Code	Colore Finishing	Potenza / Flusso Effettivo Power / Lumen Output	CCT CCT	Sorgente Source	Alimentazione Power feeding	Classe energetica Energy Label	IP IP
Recessed Downlight	INC1500	Bianco / White	max. 35 W (not incl.)	\	LED / HAGS GU10	220÷240 V - class II	A++...D	IP20
Wall mounting recessed - Squared	INC1502	Bianco / White	max. 35 W (not incl.)	\	LED / HAGS GU10	220÷240 V - class II	A++...D	IP20
Wall mounting recessed - Rectangular	INC1515	Bianco / White	max. 35 W (not incl.)	\	LED / HAGS GU10	220÷240 V - class II	A++...D	IP20

Ricambi / Spare Parts

Tutti gli apparecchi delle famiglie Ettore, Enea, Priamo e Paride sono forniti con staffa porta lampada inclusa
All fixtures of the Ettore, Enea, Priamo e Paride families are supplied with a lamp holder bracket included



Ricambio Spare part	Codice Code	Attacco Attack
Staffa/Socket	INC1506	GU10

Proiettori e Binari

Spotlights and Tracks



Slim
p.334



Ska
p.356



Ska Base
p.368



Day
p.370

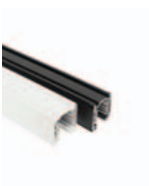

Track 4
p.372

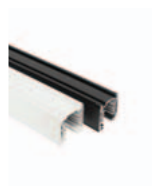

Track 6 Digital
p.374

Slim Program





Slim Program



⊕ UP TO 97 lm / W L80 / B20 50.000 h. UP TO CRI > 90 SDCM < 3   5 YEARS WARRANTY

I proiettori della serie Slim hanno dimensioni compatte e alloggiavano il driver nel corpo dell'apparecchio per un design estremamente pulito ed essenziale. La luce emessa si distingue per l'ottima diffusione del fascio e per l'elevata qualità cromatica (CRI > 90 / MacAdam < 3). Queste caratteristiche li rendono particolarmente adatti all'illuminazione dei negozi, delle aree espositive e di tutti quegli ambienti dove la resa del colore e la pulizia dei fasci luminosi sono di primaria importanza. Le lenti ottiche intercambiabili sono di tipo semidiffusivo e l'abbagliamento diretto è totalmente controllato grazie alla profonda schermatura con un cut-off di 36° che caratterizza il frontale. Oltre alle tradizionali versioni On/Off, Slim è disponibile anche nelle versioni con alimentazione DALI, Pan Digital e Casambi.

The Slim series projectors are compact and "on board" driver equipped for an extremely clean and essential design. The light emitted stands out for its excellent beam diffusion and high color quality (CRI > 90 / MacAdam < 3). These characteristics make them particularly suitable for lighting for shops, exhibition areas and all those environments where the color rendering and the quality of the light beams are fundamental requirements. The interchangeable optics are semidiffused and the direct glare is totally controlled thanks to the deep shielding with a cut-off of 36° that characterizes the front end. Slim is available for on/off switching and for DALI, Pan Digital and Casambi feeding.



- Versioni per binario 220÷240 V / 50÷60 Hz
- Installabile a soffitto con apposita basetta in accessorio
- Alimentazioni trifase per proiettori On/Off, DALI, Pan Digital, Casambi
- Adattatore a binario con selettore a 3 accensioni
- Orientabilità 90° / 350° con stop di rotazione
- Colori bianco opaco e nero opaco.
- IP20
- Led CoB 3000 K / 4000 K con resa cromatica CRI > 90 e MacAdam SDCM < 3
- No UV, No IR
- Emissioni luminose da 1070 lm a 3120 lumen
- Efficienza luminosa fino a 98 lm/W
- Efficienza energetica A
- Lifetime L80 / B20 – 50.000 h
- Lenti ottiche da 15° / 24° / 38° / 50° intercambiabili (ricambi)
- Cut-off 36°
- Griglia honeycomb in accessorio (non incluso)
- Classe "I"
- Temperatura ambiente di esercizio da -20°C a +45°C
- Certificazione CE, RoHS
- 5 anni di garanzia

- *Suitable for track 220÷240 V / 50÷60 Hz*
- *Ceiling mounted with base as accessory*
- *Switching On/Off, DALI, Pan Digital, Casambi*
- *Track plug adaptor, 3 switching way with selector*
- *Adjustable vertical aiming up to 90° / horizontal rotation 350° with stop*
- *Colours available matt white and matt black*
- *IP20*
- *Led CoB 3000 K / 4000 K; CRI > 90; MacAdam SDCM < 3*
- *No UV, No IR*
- *Light output from 1070 lm up to 3120 lm*
- *Efficacy up to 98 lm/W*
- *Energy Label A*
- *Lifetime L80 / B20 – 50.000 h*
- *Optic lens 15° / 24° / 38° / 50° (interchangable as accessory)*
- *Cut-off 36°*
- *Honeycomb grid accessory (accessory not included)*
- *Class "I"*
- *Operating from -20°C up to +45°C*
- *Compliance CE, RoHS*
- *5 years warranty*

Slim Program



12 W

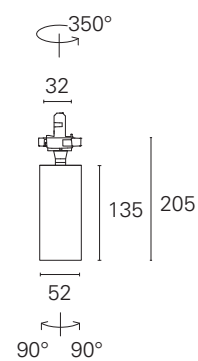

20 W

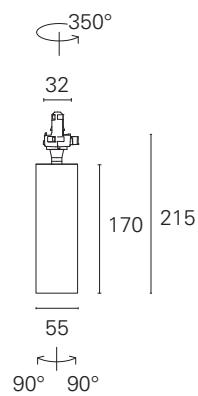

33 W

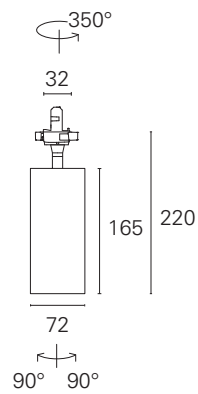

per binario **Track 4** On/Off
for track **Track 4** On/Off

On/Off

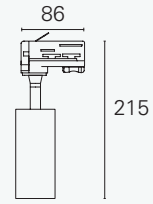

kg 0,35

per binario **Track 6** Digital
for track **Track 6** Digital

DALI

PAN DIGITAL

CASAMBI

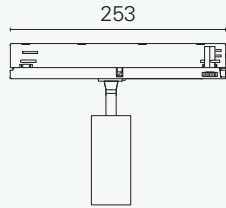

kg 0,40

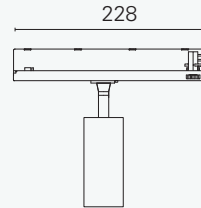

kg 0,40

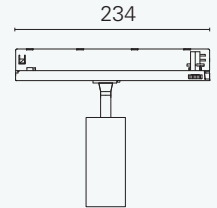

kg 0,40

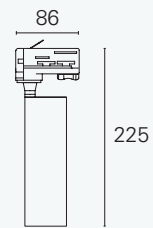

kg 0,50

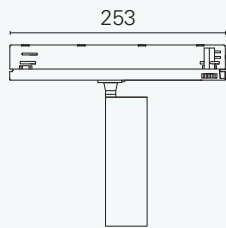

kg 0,55

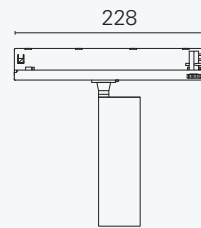

kg 0,55

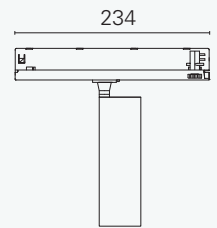

kg 0,55

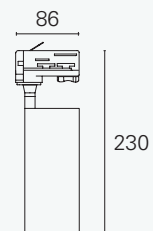

kg 0,65

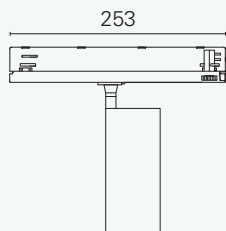

kg 0,70

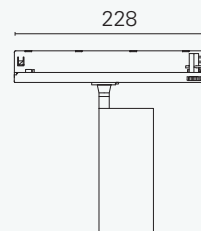

kg 0,70

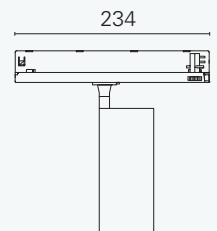

kg 0,70

Slim Program

Ottiche / *Optical Systems*

15°

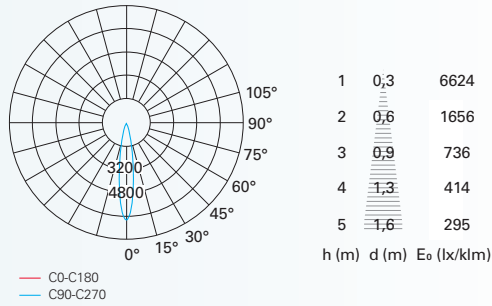

24°

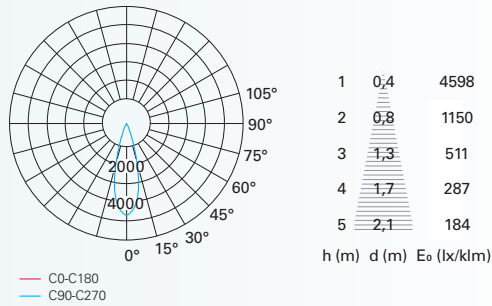

38°

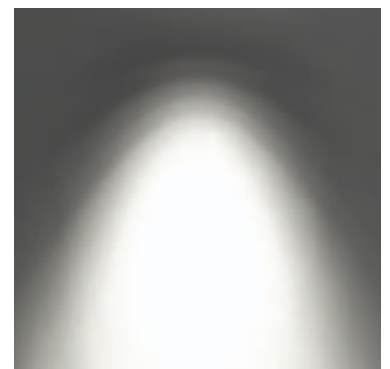
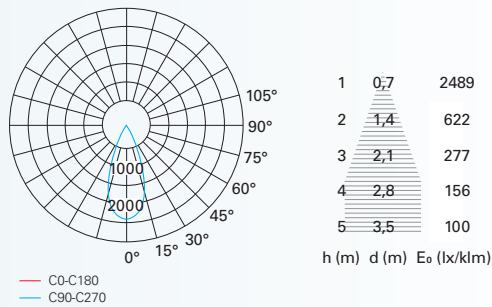

50°

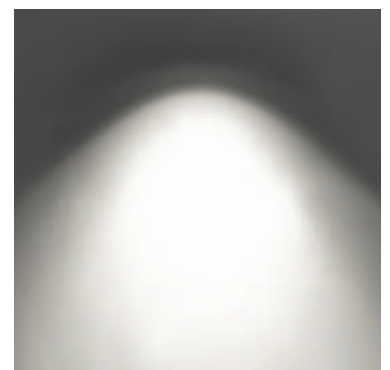
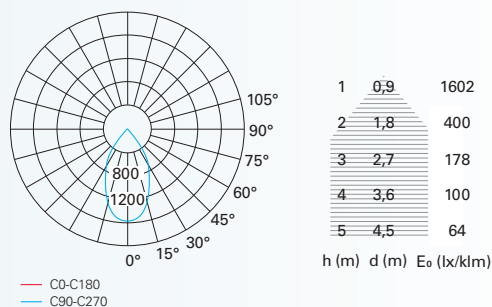



Slim Program

Resa cromatica / *Color rendering*

CRI

R1 - R15

3000 K
CRI: 91,8

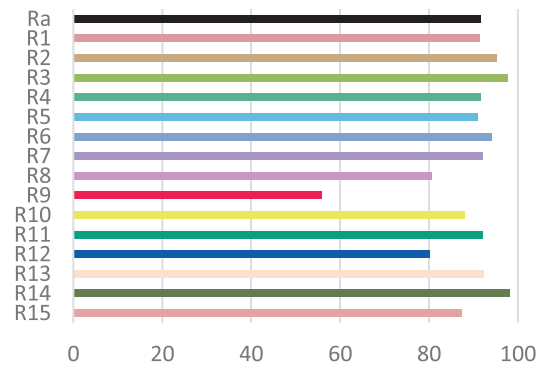
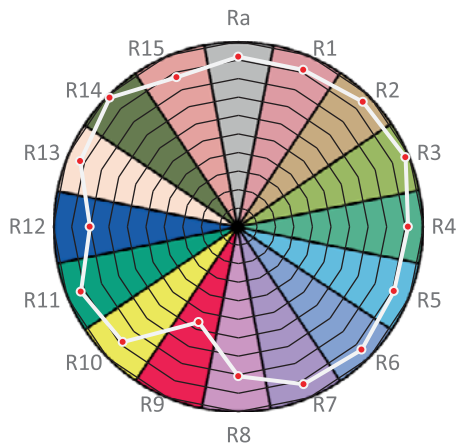

4000 K
CRI: 90,4

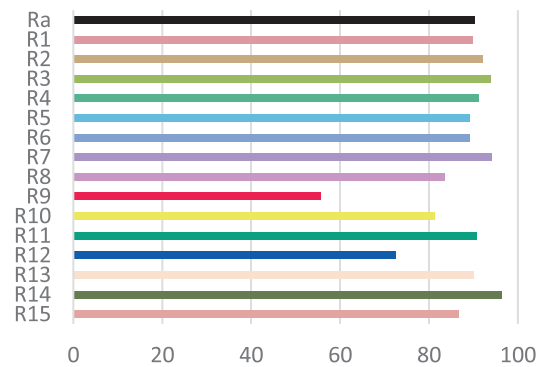
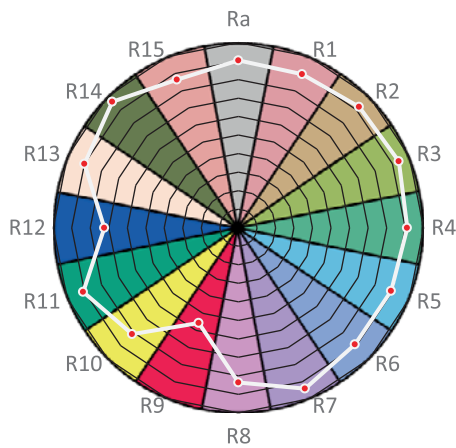

TM-30

Rf / Rg plot

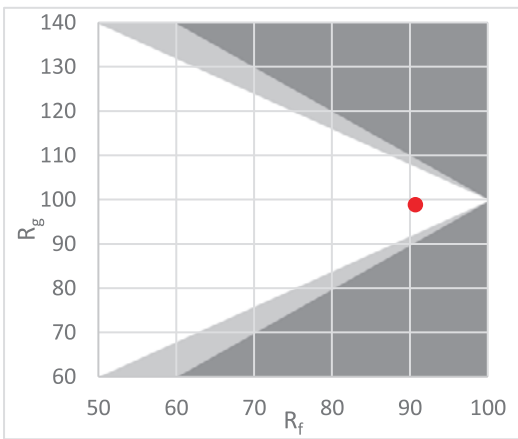

Rf 90,7
Rg 98,9

Color vector graphic

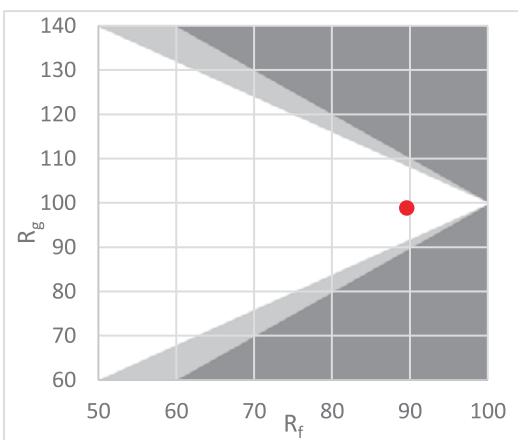
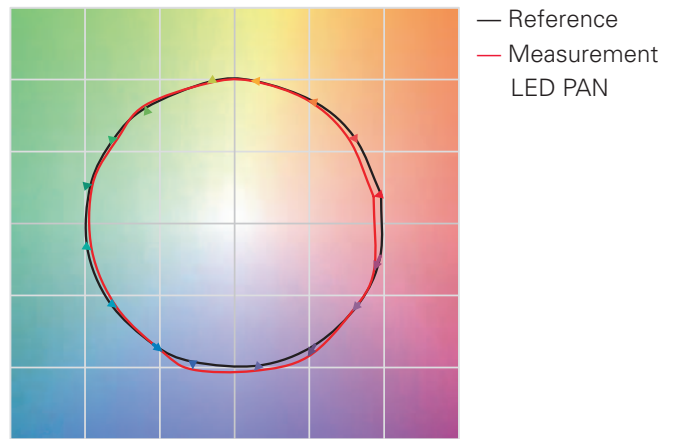

Rf 89,6
Rg 98,9

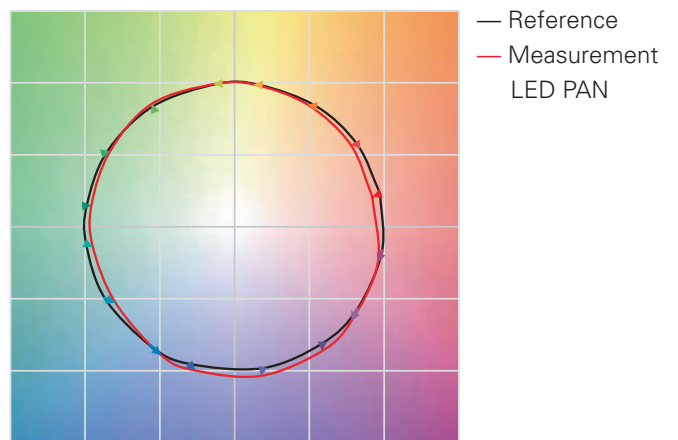



Versioni dimmerabili / Dimmable versions

con regolazione via cavo - per binario **Track 6 Digital**
wired dimmable - for Track 6 Digital

versioni <i>version</i>	suffisso codice <i>code suffix</i>	nota <i>note</i>	esempio <i>example</i>
DALI	DA	per ordinare la versione DALI aggiungere DA alla fine del codice <i>to order the DALI version add DA to the end of the code</i>	RTL-----DA

con controllo della luce wireless Bluetooth - per binario **Track 6 Digital**
wireless Bluetooth lighting control - for Track 6 Digital

versioni <i>version</i>	suffisso codice <i>code suffix</i>	nota <i>note</i>	esempio <i>example</i>
PAN Digital	PD	per ordinare la versione per smart application PAN Digital aggiungere PD alla fine del codice <i>to order the version for smart application PAN Digital add PD to the end of the code</i>	RTL-----PD
CASAMBI	CA	per ordinare la versione per smart application CASAMBI aggiungere CA alla fine del codice <i>to order the version for smart application CASAMBI add CA to the end of the code</i>	RTL-----CA

versioni Bluetooth per "smart application"; vedi dettagli alle pagine 8 - 9
Bluetooth versions for "smart application"; see details to pages 8 - 9

Accessori / Accessories

descrizione <i>description</i>	peso <i>peso</i>	12 W	20 W	33 W	
 basetta a soffitto / <i>base for ceiling mounting</i>	0,8 kg	bianco / <i>white</i>	TRK60407	TRK60407	TRK60407
		nero / <i>black</i>	TRK50407	TRK50407	TRK50407

Ricambi ottiche / Optics spare parts

descrizione <i>description</i>	peso <i>peso</i>	12 W	20 W	33 W	
 lente ottica 15° / <i>optic lens 15°</i>	0,05 kg		RTL44901R	RTL44902R	RTL44903R
		lente ottica 24° / <i>optic lens 24°</i>	RTL44904R	RTL44905R	RTL44906R
		lente ottica 38° / <i>optic lens 38°</i>	RTL44907R	RTL44908R	RTL44909R
		lente ottica 50° / <i>optic lens 50°</i>	RTL44910R	RTL44911R	RTL44912R

Slim

per binario **Track 4 On/Off**
for **Track 4 On/Off**

CRI > 90

versione version	potenza power	ottica optic	codice code	temp. di colore light temperature	CRI CRI	MacAdam SDCM	flusso apparecchio light output	colore colour	
On / Off 220 ÷ 240 V	12 W	15°	RTL43101	3000 K	> 90	< 3	1075 lm	bianco / <i>white</i>	
			RTL43102	3000 K	> 90	< 3	1075 lm	nero / <i>black</i>	
			RTL43103	4000 K	> 90	< 3	1110 lm	bianco / <i>white</i>	
			RTL43104	4000 K	> 90	< 3	1110 lm	nero / <i>black</i>	
		24°	RTL43105	3000 K	> 90	< 3	1076 lm	bianco / <i>white</i>	
			RTL43106	3000 K	> 90	< 3	1076 lm	nero / <i>black</i>	
			RTL43107	4000 K	> 90	< 3	1118 lm	bianco / <i>white</i>	
			RTL43108	4000 K	> 90	< 3	1118 lm	nero / <i>black</i>	
		38°	RTL43109	3000 K	> 90	< 3	1110 lm	bianco / <i>white</i>	
			RTL43110	3000 K	> 90	< 3	1110 lm	nero / <i>black</i>	
			RTL43111	4000 K	> 90	< 3	1144 lm	bianco / <i>white</i>	
			RTL43112	4000 K	> 90	< 3	1144 lm	nero / <i>black</i>	
	50°	RTL43113	3000 K	> 90	< 3	1158 lm	bianco / <i>white</i>		
		RTL43114	3000 K	> 90	< 3	1158 lm	nero / <i>black</i>		
		RTL43115	4000 K	> 90	< 3	1165 lm	bianco / <i>white</i>		
		RTL43116	4000 K	> 90	< 3	1165 lm	nero / <i>black</i>		
	20 W	15°	RTL43201	3000 K	> 90	< 3	1828 lm	bianco / <i>white</i>	
			RTL43202	3000 K	> 90	< 3	1828 lm	nero / <i>black</i>	
			RTL43203	4000 K	> 90	< 3	1854 lm	bianco / <i>white</i>	
			RTL43204	4000 K	> 90	< 3	1854 lm	nero / <i>black</i>	
			24°	RTL43205	3000 K	> 90	< 3	1858 lm	bianco / <i>white</i>
				RTL43206	3000 K	> 90	< 3	1858 lm	nero / <i>black</i>
				RTL43207	4000 K	> 90	< 3	1882 lm	bianco / <i>white</i>
				RTL43208	4000 K	> 90	< 3	1882 lm	nero / <i>black</i>
		38°	RTL43209	3000 K	> 90	< 3	1968 lm	bianco / <i>white</i>	
			RTL43210	3000 K	> 90	< 3	1968 lm	nero / <i>black</i>	
			RTL43211	4000 K	> 90	< 3	1962 lm	bianco / <i>white</i>	
			RTL43212	4000 K	> 90	< 3	1962 lm	nero / <i>black</i>	
		50°	RTL43213	3000 K	> 90	< 3	1964 lm	bianco / <i>white</i>	
			RTL43214	3000 K	> 90	< 3	1964 lm	nero / <i>black</i>	
			RTL43215	4000 K	> 90	< 3	1898 lm	bianco / <i>white</i>	
			RTL43216	4000 K	> 90	< 3	1898 lm	nero / <i>black</i>	
		33 W	15°	RTL43301	3000 K	> 90	< 3	3072 lm	bianco / <i>white</i>
				RTL43302	3000 K	> 90	< 3	3072 lm	nero / <i>black</i>
				RTL43303	4000 K	> 90	< 3	3098 lm	bianco / <i>white</i>
				RTL43304	4000 K	> 90	< 3	3098 lm	nero / <i>black</i>
24°				RTL43305	3000 K	> 90	< 3	3088 lm	bianco / <i>white</i>
				RTL43306	3000 K	> 90	< 3	3088 lm	nero / <i>black</i>
				RTL43307	4000 K	> 90	< 3	3102 lm	bianco / <i>white</i>
				RTL43308	4000 K	> 90	< 3	3102 lm	nero / <i>black</i>
38°	RTL43309		3000 K	> 90	< 3	3094 lm	bianco / <i>white</i>		
	RTL43310		3000 K	> 90	< 3	3094 lm	nero / <i>black</i>		
	RTL43311		4000 K	> 90	< 3	3108 lm	bianco / <i>white</i>		
	RTL43312		4000 K	> 90	< 3	3108 lm	nero / <i>black</i>		
50°	RTL43313		3000 K	> 90	< 3	3110 lm	bianco / <i>white</i>		
	RTL43314		3000 K	> 90	< 3	3110 lm	nero / <i>black</i>		
	RTL43315		4000 K	> 90	< 3	3122 lm	bianco / <i>white</i>		
	RTL43316		4000 K	> 90	< 3	3122 lm	nero / <i>black</i>		

Ska





Show Room "Rimadesio" - Pescara (PE) Italy

Ska



⊕ UP TO 99 lm / W L80 / B20 50.000h. UP TO CRI > 90 SDCM < 3 5 YEARS WARRANTY

I proiettori della serie SKA sono particolarmente indicati per l'illuminazione degli ambienti commerciali come i negozi e gli store. Le elevate prestazioni illuminotecniche consentono di illuminare adeguatamente le superfici espositive e gli oggetti esposti. I proiettori della serie Ska sono equipaggiati con driver e led CoB selezionati (prime brand) e le qualità cromatiche della luce (CRI > 90 e SDCM < 3) garantiscono un'ottima resa del colore degli oggetti illuminati. L'emissione della luce è gestita con riflettori ottici intercambiabili ad alto rendimento per ottenere la massima efficienza ottica e la massima flessibilità dell'impianto. Disponibili nelle versioni On/Off trifase e DALI monoaccensione.

The SKA projectors are particularly suitable for the lighting of commercial environments such as shops and malls. The high lighting performance allows adequate illumination of the exhibition surfaces and exposed objects. The SKA projectors are equipped with selected drivers and CoB LEDs (prime brand) and the light color qualities (CRI > 90 and SDCM < 3) guarantee an excellent color rendering of the illuminated objects. The light emission is managed with high efficacy interchangeable optics to obtain maximum efficiency and maximum flexibility. Versions available three phases On/Off or DALI single switch.

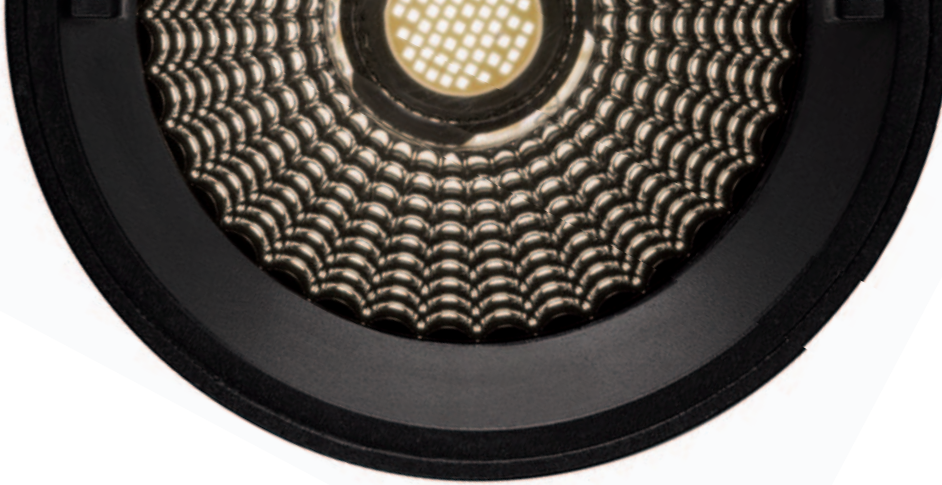

- Versioni per binario 220÷240 V / 50÷60 Hz
- Installabile a soffitto con apposita basetta in accessorio
- Disponibili nelle versioni On/Off trifase e DALI monoaccensione
- Adattatore a binario con selettore a 3 accensioni
- Orientabilità 90° / 350° con stop di rotazione
- Colori bianco opaco e nero opaco.
- IP20
- Led CoB 3000 K / 4000 K con resa cromatica CRI > 90, MacAdam SDCM < 3
- No UV, No IR
- Emissioni luminose da 1140 lm a 4350 lm
- Efficienza luminosa fino a 99 lm/W
- Efficienza energetica A
- Lifetime L80 / B20 – 50.000 h.
- Lenti ottiche da 15° / 36° / 60° intercambiabili (ricambi)
- Accessori (non inclusi): paraluce orientabili, griglia a nido d'ape, coilex nero, basetta a soffitto
- Classe "I"
- Temperatura ambiente di esercizio da -20°C a +45°C
- Certificazione CE, RoHS
- 5 anni di garanzia

- *Suitable for track 220 ÷ 240 V / 50 ÷ 60 Hz*
- *Ceiling mounted with base as accessory*
- *Versions available three phases On/Off or DALI single switch*
- *Track plug adaptor, 3 switching way with selector*
- *Adjustable vertical aiming up to 90° / horizontal rotation 350° with stop*
- *Colours available matt white and matt black*
- *IP20*
- *Led CoB 3000K / 4000K – CRI > 90, MacAdam SDCM < 3*
- *No UV, No IR*
- *Light output from 1140 lm up to 4350 lm*
- *Efficacy up to 99 lm/W*
- *Energy Label A*
- *Lifetime L80 / B20 – 50.000 h.*
- *Optic lens 15° / 36° / 60° (interchangable as accessory)*
- *barn doors, honeycomb grid, ex-snot, ceiling base (accessory not included)*
- *Class "I"*
- *Operating from -20°C up to +45°C*
- *Compliance CE, RoHS*
- *5 years warranty*

Ska



12 W

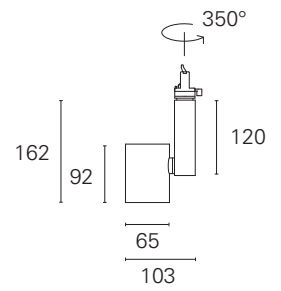

25 W

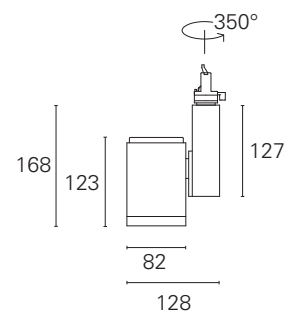

33 W

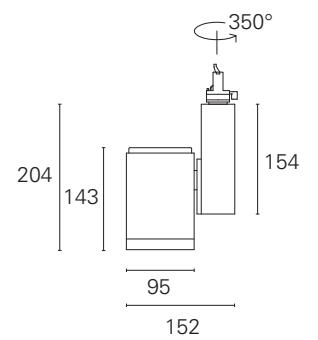

42 W

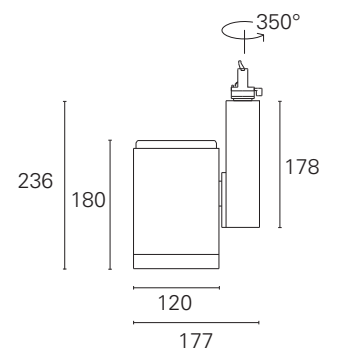

per binario **Track 4** On/Off
for track **Track 4** On/Off

On/Off

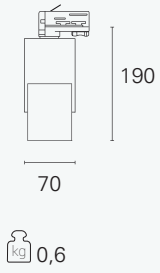

per binario **Track 4** DALI mono
for track **Track 4** DALI mono

DALI

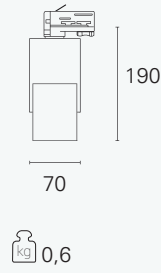

per installazione a soffitto
for ceiling mounting

BASE

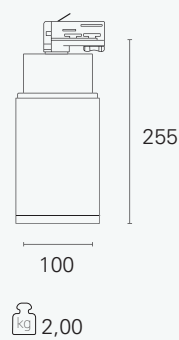
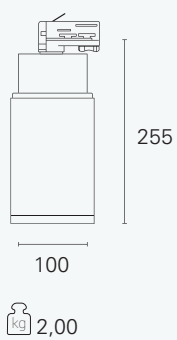
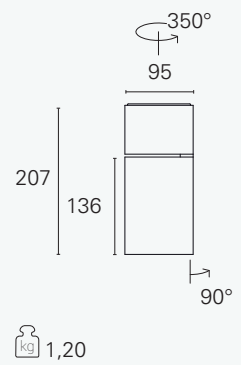
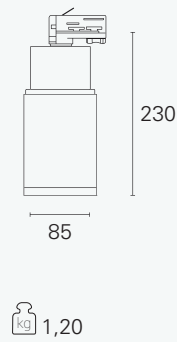
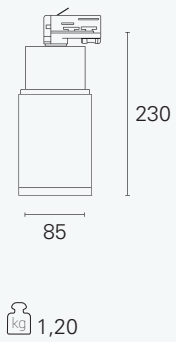
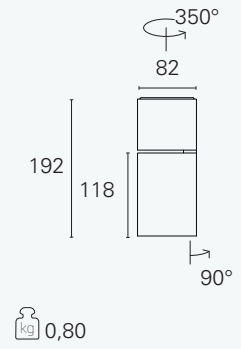
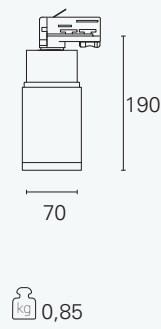
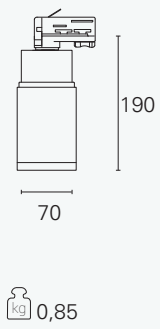

Ska

Ottiche / *Optical Systems*

15°

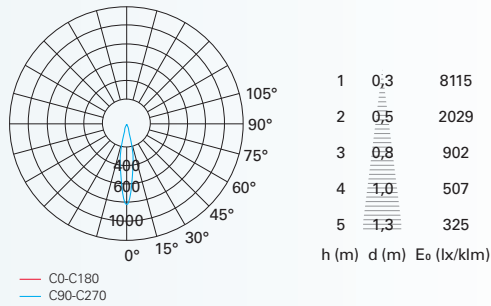

36°

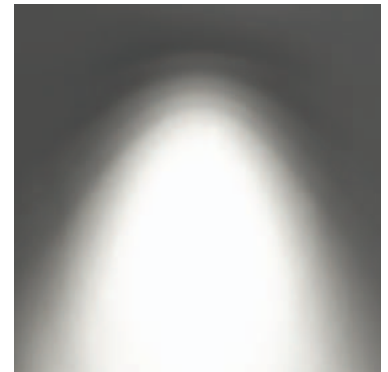
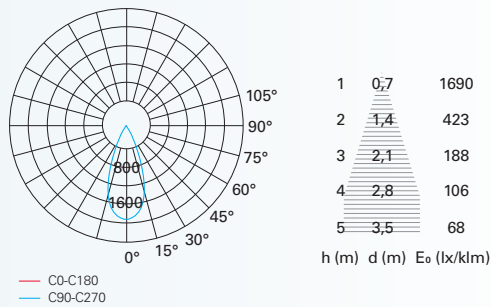

60°

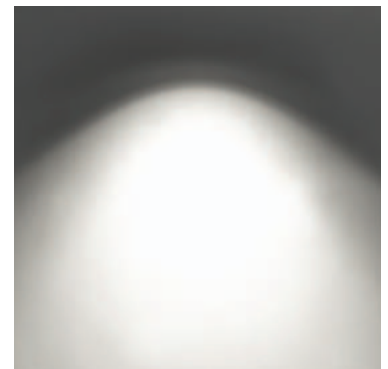
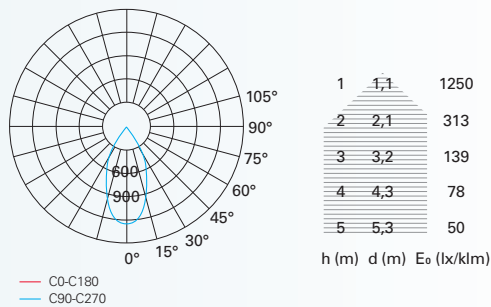

Ottiche performanti

Optic performance

Massima performance ottica. I riflettori speculari con faccette a curvatura progressiva assicurano la precisione del fascio e luce sfumata ai bordi

Maximum optic performance. The mirroring reflectors with progressive curved faccetting ensure precise beams and shading light at the edge



Ska

Resa cromatica / *Color rendering*

CRI

R1 - R15

3000 K
CRI: 92,3

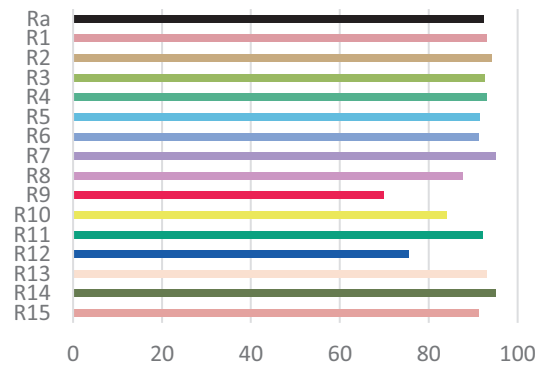
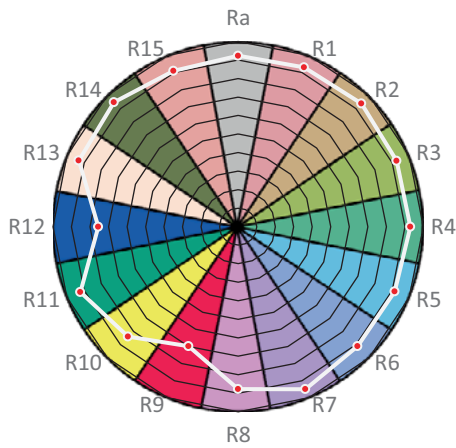

4000 K
CRI: 92,7

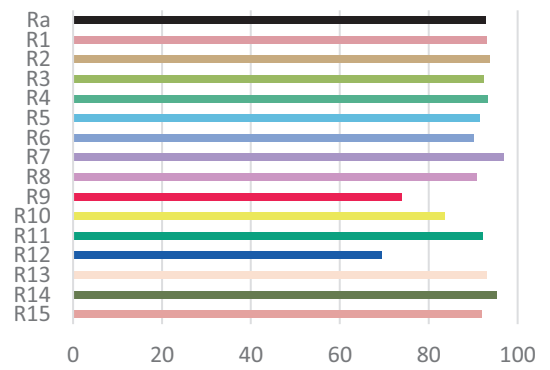
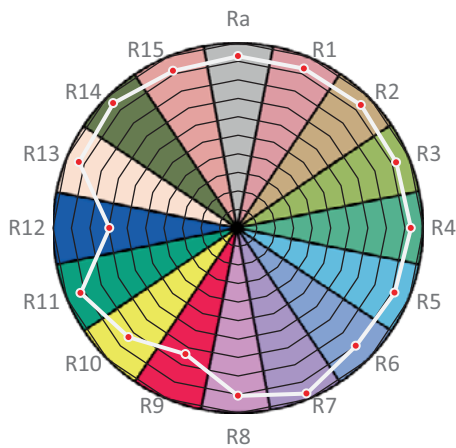

TM-30

Rf / Rg plot

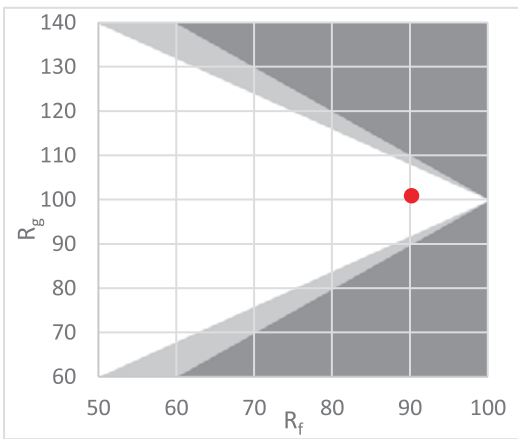

Rf 90,2
Rg 100,9

Color vector graphic

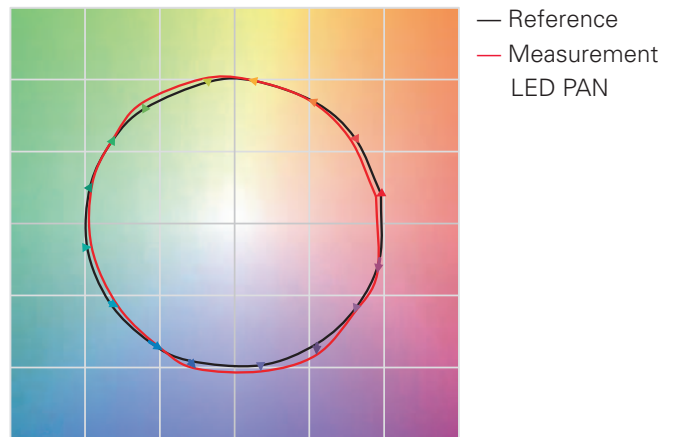

— Reference
— Measurement
LED PAN

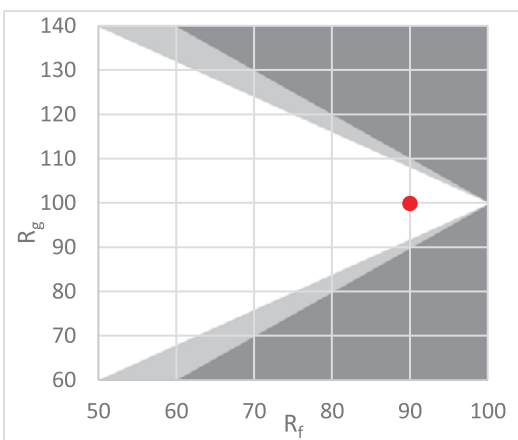

Rf 90,0
Rg 99,9

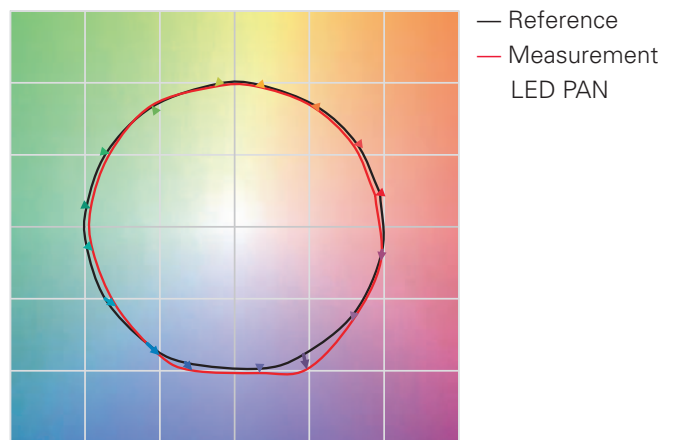

— Reference
— Measurement
LED PAN

Ska

Accessori / Accessories

La serie Ska prevede una completa gamma di accessori per la gestione del fascio luminoso che permettono il controllo dell'abbagliamento diretto.

The Ska series provides a complete range of accessories for the management of the light beam that allow direct glare control.



Frontale Antiabbagliamento / No glare Ex-Spot



Griglia Honeycomb / Honeycomb Grid



Alette Paraluce / Barn Doors



Basetta a soffitto / Base for ceiling mounting

Versioni dimmerabili / *Dimmable versions*

con regolazione via cavo - per binario **Track 4** DALI mono
wired dimmable - for Track 4 DALI mono

versioni <i>version</i>	suffisso codice <i>code suffix</i>	nota <i>note</i>	esempio <i>example</i>
DALI	DA	per ordinare la versione DALI aggiungere DA alla fine del codice <i>to order the DALI version add DA to the end of the code</i>	RTL-----DA

Accessori / *Accessories*

	descrizione <i>description</i>	colore <i>finishing</i>	peso <i>peso</i>	12 W	25 W	33 W	42 W
	griglia honeycomb / <i>honeycomb grid</i>		0,02 kg	TRK60353	TRK60358	TRK60363	TRK60367
	alette paraluce / <i>barn doors</i>		0,3 kg	\	TRK60359	TRK60364	TRK60368
	frontale / <i>ex snot</i>	bianco / <i>white</i>	0,08 kg	TRK60352	TRK60357	TRK60362	\
		nero / <i>black</i>		TRK50352	TRK50357	TRK50362	\
	basetta a soffitto / <i>base for ceiling mounting</i>	bianco / <i>white</i>	0,8 kg	TRK60407	TRK60407	TRK60407	TRK60407
		nero / <i>black</i>		TRK50407	TRK50407	TRK50407	TRK50407

Ricambi / *Spare parts*

	descrizione <i>description</i>	peso <i>peso</i>	12 W	25 W	33 W	42 W
	lente ottica 15° / <i>optic lens 15°</i>	0,06 g	U00109	U00106	U00103	U00130
	lente ottica 24° / <i>optic lens 24°</i>		U00110	U00107	U00104	U00131
	lente ottica 36° / <i>optic lens 36°</i>		U00111	U00108	U00105	U00132
	lente ottica 60° / <i>optic lens 60°</i>		U00120	U00119	U00118	U00133



Ska

per binario **Track 4 On/Off**
for **Track 4 On/Off**

CRI > 90

versione version	potenza power	ottica optic	codice code	temp. di colore light temperature	CRI CRI	MacAdam SDCM	flusso apparecchio light output	colore colour	
On / Off 220 ÷ 240 V	12 W	15°	RTL46101	3000 K	> 90	< 3	1145 lm	bianco / <i>white</i>	
			RTL46102	3000 K	> 90	< 3	1145 lm	nero / <i>black</i>	
			RTL46103	4000 K	> 90	< 3	1160 lm	bianco / <i>white</i>	
			RTL46104	4000 K	> 90	< 3	1160 lm	nero / <i>black</i>	
	36°	12 W	36°	RTL46105	3000 K	> 90	< 3	1152 lm	bianco / <i>white</i>
				RTL46106	3000 K	> 90	< 3	1152 lm	nero / <i>black</i>
				RTL46107	4000 K	> 90	< 3	1165 lm	bianco / <i>white</i>
				RTL46108	4000 K	> 90	< 3	1165 lm	nero / <i>black</i>
	60°	12 W	60°	RTL46109	3000 K	> 90	< 3	1174 lm	bianco / <i>white</i>
				RTL46110	3000 K	> 90	< 3	1174 lm	nero / <i>black</i>
				RTL46111	4000 K	> 90	< 3	1185 lm	bianco / <i>white</i>
				RTL46112	4000 K	> 90	< 3	1185 lm	nero / <i>black</i>
25 W	15°	15°	RTL46201	3000 K	> 90	< 3	2380 lm	bianco / <i>white</i>	
			RTL46202	3000 K	> 90	< 3	2380 lm	nero / <i>black</i>	
			RTL46203	4000 K	> 90	< 3	2422 lm	bianco / <i>white</i>	
			RTL46204	4000 K	> 90	< 3	2422 lm	nero / <i>black</i>	
	36°	25 W	36°	RTL46205	3000 K	> 90	< 3	2395 lm	bianco / <i>white</i>
				RTL46206	3000 K	> 90	< 3	2395 lm	nero / <i>black</i>
				RTL46207	4000 K	> 90	< 3	2365 lm	bianco / <i>white</i>
				RTL46208	4000 K	> 90	< 3	2365 lm	nero / <i>black</i>
	60°	25 W	60°	RTL46209	3000 K	> 90	< 3	2387 lm	bianco / <i>white</i>
				RTL46210	3000 K	> 90	< 3	2387 lm	nero / <i>black</i>
				RTL46211	4000 K	> 90	< 3	2415 lm	bianco / <i>white</i>
				RTL46212	4000 K	> 90	< 3	2415 lm	nero / <i>black</i>
33 W	15°	15°	RTL46301	3000 K	> 90	< 3	3164 lm	bianco / <i>white</i>	
			RTL46302	3000 K	> 90	< 3	3164 lm	nero / <i>black</i>	
			RTL46303	4000 K	> 90	< 3	3225 lm	bianco / <i>white</i>	
			RTL46304	4000 K	> 90	< 3	3225 lm	nero / <i>black</i>	
	36°	33 W	36°	RTL46305	3000 K	> 90	< 3	3180 lm	bianco / <i>white</i>
				RTL46306	3000 K	> 90	< 3	3180 lm	nero / <i>black</i>
				RTL46307	4000 K	> 90	< 3	3215 lm	bianco / <i>white</i>
				RTL46308	4000 K	> 90	< 3	3215 lm	nero / <i>black</i>
	60°	33 W	60°	RTL46309	3000 K	> 90	< 3	3195 lm	bianco / <i>white</i>
				RTL46310	3000 K	> 90	< 3	3195 lm	nero / <i>black</i>
				RTL46311	4000 K	> 90	< 3	3252 lm	bianco / <i>white</i>
				RTL46312	4000 K	> 90	< 3	3252 lm	nero / <i>black</i>
42 W	15°	15°	RTL46401	3000 K	> 90	< 3	3990 lm	bianco / <i>white</i>	
			RTL46402	3000 K	> 90	< 3	3990 lm	nero / <i>black</i>	
			RTL46403	4000 K	> 90	< 3	4005 lm	bianco / <i>white</i>	
			RTL46404	4000 K	> 90	< 3	4005 lm	nero / <i>black</i>	
	36°	42 W	36°	RTL46405	3000 K	> 90	< 3	4000 lm	bianco / <i>white</i>
				RTL46406	3000 K	> 90	< 3	4000 lm	nero / <i>black</i>
				RTL46407	4000 K	> 90	< 3	4015 lm	bianco / <i>white</i>
				RTL46408	4000 K	> 90	< 3	4015 lm	nero / <i>black</i>
	60°	42 W	60°	RTL46409	3000 K	> 90	< 3	4004 lm	bianco / <i>white</i>
				RTL46410	3000 K	> 90	< 3	4004 lm	nero / <i>black</i>
				RTL46411	4000 K	> 90	< 3	4021 lm	bianco / <i>white</i>
				RTL46412	4000 K	> 90	< 3	4021 lm	nero / <i>black</i>



Ska Base

CRI > 90

versione version	potenza power	ottica optic	codice code	temp. di colore light temperature	CRI CRI	MacAdam SDCM	flusso apparecchio light output	colore colour
On / Off 220 ÷ 240 V	25 W	15°	RTL47201	3000 K	> 90	< 3	2380 lm	bianco / <i>white</i>
			RTL47202	3000 K	> 90	< 3	2380 lm	nero / <i>black</i>
			RTL47203	4000 K	> 90	< 3	2450 lm	bianco / <i>white</i>
			RTL47204	4000 K	> 90	< 3	2450 lm	nero / <i>black</i>
		36°	RTL47205	3000 K	> 90	< 3	2395 lm	bianco / <i>white</i>
			RTL47206	3000 K	> 90	< 3	2395 lm	nero / <i>black</i>
			RTL47207	4000 K	> 90	< 3	2450 lm	bianco / <i>white</i>
			RTL47208	4000 K	> 90	< 3	2450 lm	nero / <i>black</i>
	60°	RTL47209	3000 K	> 90	< 3	2407 lm	bianco / <i>white</i>	
		RTL47210	3000 K	> 90	< 3	2407 lm	nero / <i>black</i>	
		RTL47211	4000 K	> 90	< 3	2432 lm	bianco / <i>white</i>	
		RTL47212	4000 K	> 90	< 3	2432 lm	nero / <i>black</i>	
	33 W	15°	RTL47301	3000 K	> 90	< 3	3164 lm	bianco / <i>white</i>
			RTL47302	3000 K	> 90	< 3	3164 lm	nero / <i>black</i>
			RTL47303	4000 K	> 90	< 3	3235 lm	bianco / <i>white</i>
			RTL47304	4000 K	> 90	< 3	3235 lm	nero / <i>black</i>
36°		RTL47305	3000 K	> 90	< 3	3180 lm	bianco / <i>white</i>	
		RTL47306	3000 K	> 90	< 3	3180 lm	nero / <i>black</i>	
		RTL47307	4000 K	> 90	< 3	3240 lm	bianco / <i>white</i>	
		RTL47308	4000 K	> 90	< 3	3240 lm	nero / <i>black</i>	
60°		RTL47309	3000 K	> 90	< 3	3195 lm	bianco / <i>white</i>	
		RTL47310	3000 K	> 90	< 3	3195 lm	nero / <i>black</i>	
		RTL47311	4000 K	> 90	< 3	3248 lm	bianco / <i>white</i>	
		RTL47312	4000 K	> 90	< 3	3248 lm	nero / <i>black</i>	



Day Track



⊕ UP TO 94 lm / W 3000 K / 4000 K

Day è la soluzione Ideale per illuminare con luce diffusa i negozi e le aree commerciali sostituendo le tradizionali lampade fluorescenti lineari. Può essere utilizzato in combinazione con i proiettori Ska e Slim e, grazie agli adattatori eurostandard inclusi, può essere installato sui binari trifase della serie Track. È equipaggiato con led in linea abbinati ad uno schermo diffondente in modo da ottenere un'illuminazione diffusa che ammorbidisce le ombre tipiche della luce dei proiettori.

Day is the ideal solution for the lighting of shops and commercial areas with diffused light, replacing traditional linear fluorescent lamps. In accordance with Ska and Slim projectors and thanks to the included eurostandard adapters, it can be installed on the three-phase tracks series. Equipped with in-line LEDs, combined with a diffusing screen, to obtain a diffused lighting mitigating the shadow effect typical of the projectors light.

Dimensioni / Dimensions

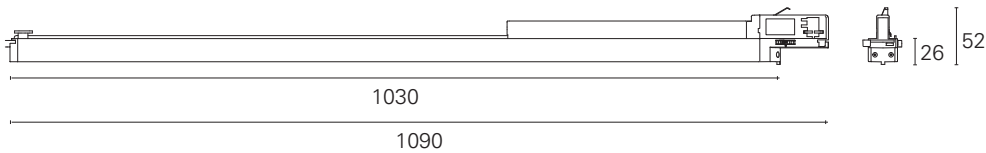

0,73

Ottiche / Optics

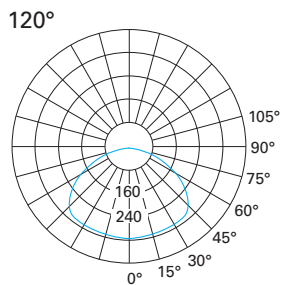

— C0-C180
— C90-C270

1	4,1	309
1.5	6,2	137
2	8,2	77
2.5	10	49
3	12	34

h (m) d (m) E_s (lx/klm)

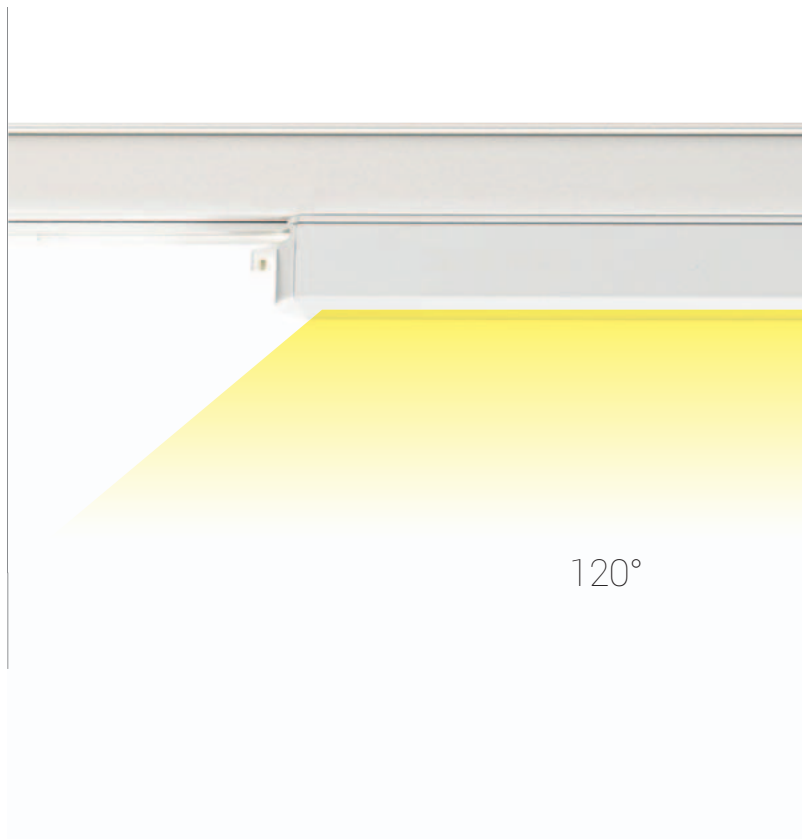

Day Track

per binario **Track 4** On/Off
for **Track 4** On/Off

CRI > 80

versione version	potenza power	ottica optic	codice code	temp. di colore light temperature	CRI CRI	MacAdam SDCM	flusso apparecchio light output	colore colour
On / Off 220 ÷ 240 V	30 W	120°	TRK80502	3000 K	> 80	\	2640 lm	bianco / white
			TRK80503	4000 K	> 80	\	2820 lm	bianco / white
			TRK80502N	3000 K	> 80	\	2640 lm	nero / black
			TRK80503N	4000 K	> 80	\	2820 lm	nero / black

Track 4

Track 4 - On-Off

Track 4 è un binario trifase a quattro conduttori; permette la realizzazione di impianti con tre accensioni separate utilizzando il conduttore neutro in comune; disponibile in colore bianco o nero, è utilizzabile per proiettori con accensione On/Off ed è disponibile per installazioni a plafone o a sospensione.

Track 4 is a three-phase four conductors track; allows the construction of systems with three separate ignitions using the common neutral conductor; available in white or black, it can be used for projectors with On / Off ignition and is available for ceiling or suspended installations.

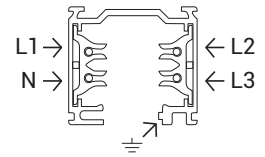

Solo per / Suitable only for:
Slim On/Off / Ska On/Off / Day

Track 4 - DALI Mono

La versione DALI Mono di Track 4 è un binario trifase a quattro conduttori per realizzare impianti DALI con unica accensione; ai collegamenti di linea e neutro si affiancano due conduttori per la trasmissione del segnale digitale DALI. Disponibile per installazioni a plafone e a sospensione.

The DALI Mono version of Track 4 is a three-phase four conductor track for DALI single ignition systems; the line and neutral connectors are flanked by two conductors specific for DALI digital signal.

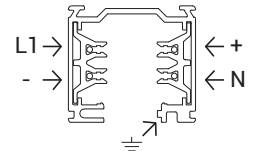

Solo per / Suitable only for:
Ska DALI

On / Off

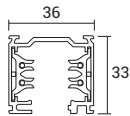

Binario trifase on-off. (*)
3-phase on-off track.

codice code	lunghezza length	colore colour
30203NV	100 cm	nero / black
30203BV	100 cm	bianco / white
30200NV	200 cm	nero / black
30200BV	200 cm	bianco / white
30223NV	300 cm	nero / black
30223BV	300 cm	bianco / white

On / Off

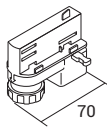

Adattatore elettromeccanico 6A.
Electro/mechanical adapter 6A.

codice code	colore colour
30201NV on-off	nero / black
30201BV on-off	bianco / white

Terminale di chiusura.
Dead end.

codice code	colore colour
30222NV on-off / DALI	nero / black
30222BV on-off / DALI	bianco / white

Alimentazione sinistra.
Left live-end.

codice code	colore colour
30204NV on-off	nero / black
30204BV on-off	bianco / white
30204NVDA DALI	nero / black
30204BVDA DALI	bianco / white

DALI

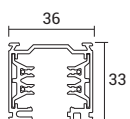

Binario monofase dimmerabile. (*)
single-phase dimmable track.

codice code	lunghezza length	colore colour
30203NVDA	100 cm	nero / black
30203BVDA	100 cm	bianco / white
30200NVDA	200 cm	nero / black
30200BVDA	200 cm	bianco / white
30223NVDA	300 cm	nero / black
30223BVDA	300 cm	bianco / white

DALI

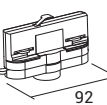

Adattatore elettrificato 6A.
Electro/mechanical adapter 6A.

codice code	colore colour
30201NVDA DALI	nero / black
30201BVDA DALI	bianco / white

Alimentazione destra.
Right live-end.

codice code	colore colour
30205NV on-off	nero / black
30205BV on-off	bianco / white
30205NVDA DALI	nero / black
30205BVDA DALI	bianco / white

Alimentazione centrale e giunto lineare.
Central connector and straight joint.

codice code	colore colour
30207NV on-off	nero / black
30207BV on-off	bianco / white
30207NVDA DALI	nero / black
30207BVDA DALI	bianco / white

(*) Il binario può sopportare un carico di 10 kg utilizzando un kit di sospensione ogni 80 cm.

The track has a load capacity of 10 kg using one pendant kit every 80 cm.

Continuità della messa a terra Continuity of the earthing

Per una corretta installazione di tutti gli accessori che concorrono alla formazione di un impianto di binari trifase, è necessario garantire la continuità della linea di messa a terra tra ogni elemento. Il posizionamento dei conduttori di terra, infatti, deve essere consequenziale tra componente e componente.

For a correct installation of all the accessories in a three-phase track composition, the continuity of the earth connection between each element must be guaranteed. The earth conductors of each component must be positioned consistently.

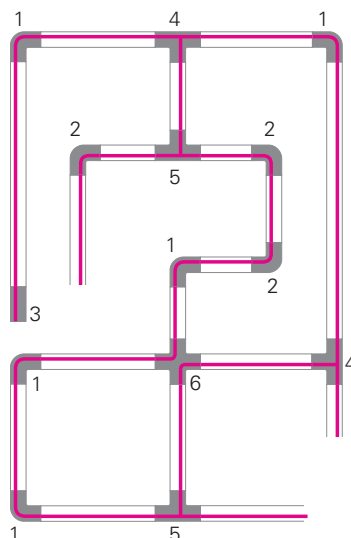

1 Giunto "L" esterno.
Outside "L" joint.



2 Giunto "L" interno.
Inside "L" joint.



3 Alimentazione destra.
Right live-end.



4 Giunto "T" destra.
Right "T" joint.



5 Giunto "T" sinistro.
Left "T" joint.



6 Giunto a "X".
"X" joint.

Giunzioni / Joints

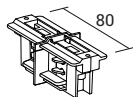

Giunto lineare con contatti e con blocco.
Electrical straight joint with stop.

codice code	colore colour
30210NV on-off / DALI	nero / black
30210BV on-off / DALI	bianco / white

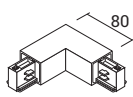

Giunto "L" interno.
Inside "L" joint.

codice code	colore colour
30215NV on-off / DALI	nero / black
30215BV on-off / DALI	bianco / white

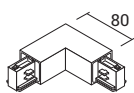

Giunto "L" esterno.
Outside "L" joint.

codice code	colore colour
30216NV on-off / DALI	nero / black
30216BV on-off / DALI	bianco / white

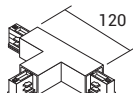

Giunto "T" sinistro.
Left "T" joint.

codice code	colore colour
30218NV on-off / DALI	nero / black
30218BV on-off / DALI	bianco / white

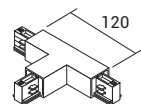

Giunto "T" destro.
Right "T" joint.

codice code	colore colour
30219NV on-off / DALI	nero / black
30219BV on-off / DALI	bianco / white

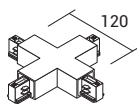

Giunto "X".
"X" joint.

codice code	colore colour
30220NV on-off / DALI	nero / black
30220BV on-off / DALI	bianco / white

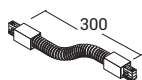

Giunto flessibile.
Flexible joint.

codice code	colore colour
30213NV on-off / DALI	nero / black
30213BV on-off / DALI	bianco / white

Soffitto / Ceiling



Kit attacco soffitto.
Ceiling kit.

codice code	colore colour
30221 on-off / DALI	/

Sospensioni / Pendants

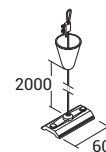

Kit coppia (2pcs) con cavo acciaio 200 cm. e piastrina 6 cm.
Suspension kit (2pcs) with steel wire 200 cm. and 6 cm. plate.

codice code	colore colour
30211NV on-off / DALI	nero / black
30211BV on-off / DALI	bianco / white

Rosoni / Canopy



Rosone per collegamento On / Off 300 cm.
Canopy On / Off - 300 cm.

codice code	colore colour
SOS50018 on-off	bianco / white



Rosone per collegamento DALI 300 cm.
Canopy DALI - 300 cm.

codice code	colore colour
SOS50017 DALI	bianco / white

Track 6 Digital

Track 6 - DALI Multi

Track 6 Digital è un binario trifase a sei conduttori; permette la realizzazione di impianti DALI con tre accensioni separate utilizzando il conduttore neutro in comune e due conduttori di segnale D+/D-; disponibile in colore bianco o nero, è utilizzabile con proiettori DALI ed è disponibile per installazioni a plafone o a sospensione. Lo stesso binario Track 6 DALI Multi è utilizzabile anche con le versioni digitali Bluetooth dei proiettori Slim nei i sistemi PAN Digital e Casambi.

Track 6 Digital is a three-phase six-conductor track; allows to install DALI systems with three separate ignitions using the common neutral conductor and also two D + / D- signal conductors; available in white or black, it can be used with DALI spotlights and is available for ceiling or suspended installations. The same Track 6 DALI Multi track can also be used with the digital Bluetooth versions of the Slim projectors in the PAN Digital and Casambi systems

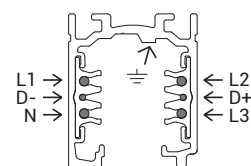

Solo per / Suitable only for:
Slim DALI
Slim Pan Digital
Slim Casambi

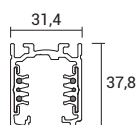

Binario trifase DALI
 3-phase DALI track.

codice code	lunghezza length	colore colour
60203BS	100 cm	bianco / white
60203NS	100 cm	nero / black
60200BS	200 cm	bianco / white
60200NS	200 cm	nero / black
60223BS	300 cm	bianco / white
60223NS	300 cm	nero / black



Tappo di chiusura con vite a blocco.
 End cap with locking screw.

codice code	colore colour
60222BS	bianco / white
60222NS	nero / black

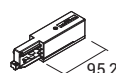

Testata di alimentazione (R - pol. sx/terra dx).
 End feed (R - pol. L/earth R).

codice code	DALI	colore colour
60205BS		bianco / white
60205NS		nero / black

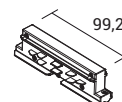

Giunto passante.
 Joining connector.

codice code	DALI	colore colour
60210BS		bianco / white
60210NS		nero / black

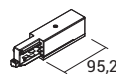

Testata di alimentazione (L - pol. dx/terra sx).
 End feed (L - pol. R/earth L).

codice code	DALI	colore colour
60204NS		bianco / white
60204BS		nero / black

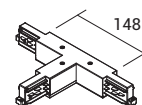

Giunto a T (pol. int. sx/terra est. dx).
 T-feed (pol. int. L/earth ext. R).

codice code	DALI	colore colour
60218BS		bianco / white
60218NS		nero / black

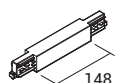

Giunto diretto.
 Middle feed.

codice code	DALI	colore colour
60207BS		bianco / white
60207NS		nero / black

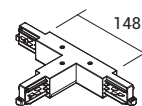

Giunto a T (pol. est. dx/terra int. sx).
 T-feed (pol. ext. R/earth ext. L).

codice code	DALI	colore colour
60225BS		bianco / white
60225NS		nero / black

(*) Il binario può sopportare un carico di 25 kg utilizzando un kit di sospensione ogni 90 cm.

The track has a load capacity of 25 kg using one pendant kit every 90 cm.

Continuità della messa a terra Continuity of the earthing

Per una corretta installazione di tutti gli accessori che concorrono alla formazione di un impianto di binari trifase, è necessario garantire la continuità della linea di messa a terra tra ogni elemento. Il posizionamento dei conduttori di terra, infatti, deve essere consequenziale tra componente e componente.

For a correct installation of all the accessories in a three-phase track composition, the continuity of the earth connection between each element must be guaranteed. The earth conductors of each component must be positioned consistently.

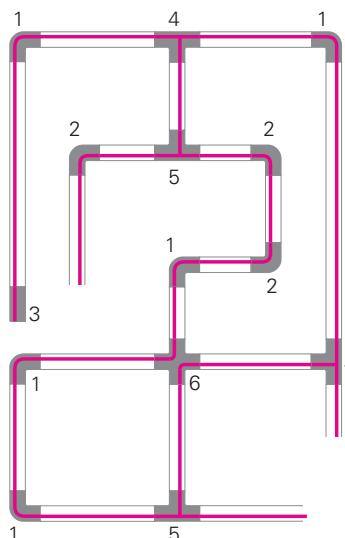

1 Giunto a L (pol. est./terra int).
L-feed (pol. ext./earth int).



2 Giunto a L (pol. int./terra est).
L-feed (pol. int./earth ext.).



3 Testata di alimentazione (R - pol. sx/terra dx).
End feed (R - pol. L/earth R).



4 Giunto a T (pol. est. sx/terra int. dx).
T-feed (pol. ext. L/earth ext. R).



5 Giunto a T (pol. est. dx/terra int. sx).
T-feed (pol. ext. R/earth ext. L).



6 Giunto a X.
X-feed.

Giunzioni / Joints

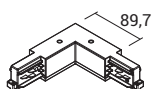

Giunto a L (pol. int./terra est).
L-feed (pol. int./earth ext.).

codice code		colore colour
60215BS	DALI	bianco / white
60215NS	DALI	nero / black

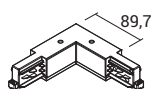

Giunto a L (pol. est./terra int).
L-feed (pol. ext./earth int).

codice code		colore colour
60216BS	DALI	bianco / white
60216NS	DALI	nero / black

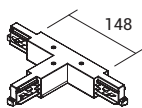

Giunto a T (pol. int. dx/terra est. sx).
T-feed (pol. int. R/earth ext. L).

codice code		colore colour
60219BS	DALI	bianco / white
60219NS	DALI	nero / black

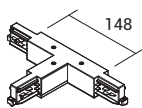

Giunto a T (pol. est. sx/terra int. dx).
T-feed (pol. ext. L/earth ext. R).

codice code		colore colour
60224BS	DALI	bianco / white
60224NS	DALI	nero / black

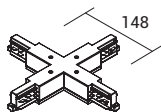

Giunto a X.
X-feed.

codice code		colore colour
60220BS	DALI	bianco / white
60220NS	DALI	nero / black

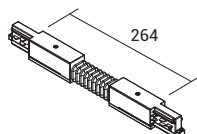

Giunto flessibile.
Adjustable corner

codice code		colore colour
60213BS	DALI	bianco / white
60213NS	DALI	nero / black

Sospensioni / Pendants

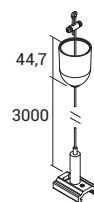

Kit completi per il fissaggio a sospensione
300 cm.
Complete suspension kits 300 cm.

codice code		colore colour
60211BS	DALI	bianco / white
60211NS	DALI	nero / black

Soffitto / Ceiling



Staffa per fissaggio a soffitto.
Ceiling bracket.

codice code		colore colour
60221BS		bianco / white
60221NS		nero / black

Rosoni / Canopy

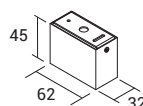

Rosone per fissaggio a soffitto.
Cavo non incluso.
Canopy for ceiling mounting.
Wiring cable not included.

codice code		colore colour
60212BS	DALI	bianco / white



Gancio di sospensione.
Suspension hook.

codice code		colore colour
60227BS		bianco / white
60227NS		nero / black

Plafoniere

Ceiling Mounted



Hoop Ceiling
p.378



Corona Ceiling
p.380



Kart Ceiling
p.382



Bike Ceiling
p.384



Penny Ceiling
p.386



Play
p.388



Dama
p.390



Young
p.392



Gipsy
p.393



Orion
p.394

Hoop Ceiling



220÷240 V

SMD Led



Hoop è una plafoniera realizzata in alluminio verniciato bianco opaco ed equipaggiata di schermo diffondente in PMMA. Permette di ottenere una luce morbida e diffusa per illuminare gli ambienti in modo confortevole e senza la presenza di ombre dure. Il driver è incluso nell'apparecchio, può essere On/Off o dimmerabile multifunzione con controllo 1...10V, Push, DALI, ed alimenta le sorgenti LED SMD ad alta efficienza. Hoop è disponibile nella versione a plafone in diverse misure e potenze, e si completa con le analoghe versioni a sospensione. Disponibile nelle versioni dimmerabili "signal wireless" Bluetooth per reti mesh Pan Digital o Casambi.

Hoop is aluminium ceiling luminaire matt white painted, equipped with a diffusing screen in PMMA. It allows to obtain a soft and diffused light to illuminate indoor ambients comfortably and without harsh shadows. The driver is included in the fixture, it can be On/Off or dimmable multifunction 1...10 V, Push, DALI controlled, and feeds a highly efficient SMD LED source. Hoop is available in the ceiling version in different sizes and light emissions and is completed with the same suspension versions. Available in dimmable "wireless signal" Bluetooth versions for Pan Digital or Casambi mesh network.

Dimensioni / Dimensions

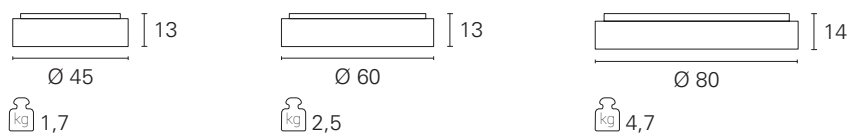

Ottiche / Optics

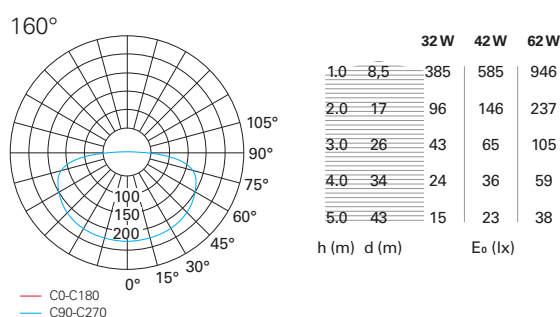

Hoop Pendant
pag. 398



Hoop Ceiling

modello model	versione version	codice code	colore finishing	Potenza / Flusso Effettivo Power / Lumen Output	CCT CCT	Alimentazione Power feed	IP IP
On / Off	Ceiling mounting - Ø 45	PLA00134	Bianco / White	32 W / 1920 lm	3000 K	220÷240 V - class I	IP20
	Ceiling mounting - Ø 60	PLA00137	Bianco / White	42 W / 2520 lm	3000 K	220÷240 V - class I	IP20
	Ceiling mounting - Ø 80	PLA00139	Bianco / White	62 W / 3720 lm	3000 K	220÷240 V - class I	IP20
Dimmerabile DALI / 1...10 V / Push	Ceiling mounting - Ø 45	PLA00134DA	Bianco / White	32 W / 1920 lm	3000 K	220÷240 V - class I	IP20
	Ceiling mounting - Ø 60	PLA00137DA	Bianco / White	42 W / 2520 lm	3000 K	220÷240 V - class I	IP20
	Ceiling mounting - Ø 80	PLA00139DA	Bianco / White	62 W / 3720 lm	3000 K	220÷240 V - class I	IP20

Versioni dimmerabili: regolazione della luminosità 0/1 - 100 % - Dimmable versions: light regulation 0/1 - 100 %

Versioni dimmerabili / Dimmable versions

con controllo della luce wireless Bluetooth
wireless Bluetooth lighting control

versioni version	suffisso codice code suffix	nota note	esempio example
PAN Digital	PD	per ordinare la versione per smart application PAN Digital aggiungere PD alla fine del codice to order the version for smart application PAN Digital add PD to the end of the code	PLA-----PD
CASAMBI	CA	per ordinare la versione per smart application CASAMBI aggiungere CA alla fine del codice to order the version for smart application CASAMBI add CA to the end of the code	PLA-----CA

versioni Bluetooth per "smart application"; vedi dettagli alle pagine 8 - 9
Bluetooth versions for "smart application"; see details to pages 8 - 9

Corona Ceiling



220÷240 V

SMD Led



Corona è realizzata in alluminio verniciato bianco opaco ed è dotata di schermo diffondente in PMMA che permette di ottenere effetti di luce morbida e diffusa. La curvatura del corpo in alluminio si abbina perfettamente alla curvatura dello schermo interno in PMMA per realizzare un'unica forma dal design morbido e contemporaneo. La sorgente SMD LED ad alta efficienza è alimentata dal driver integrato nell'apparecchio e può essere On/Off o dimmerabile multifunzione con controllo 1...10V, Push, DALI. Corona è disponibile in diverse misure e potenze e si abbina alle versioni a sospensione. Disponibile nelle versioni dimmerabili "signal wireless" Bluetooth per reti mesh Pan Digital o Casambi

Corona is made of matt white painted aluminium and is equipped with a PMMA diffusing screen which allows to obtain soft and diffused light effects. The curvature of the aluminium body perfectly matches the curvature of the internal PMMA screen to create a single shape with a soft and contemporary design. The high efficiency SMD LED source is powered by the driver integrated in the fixture and can be On/Off or dimmable multifunction 1...10 V, Push, DALI controlled. Corona is available in different sizes and powers and goes well with the suspension versions. Available in dimmable "wireless signal" Bluetooth versions for Pan Digital or Casambi mesh network.

Dimensioni / Dimensions

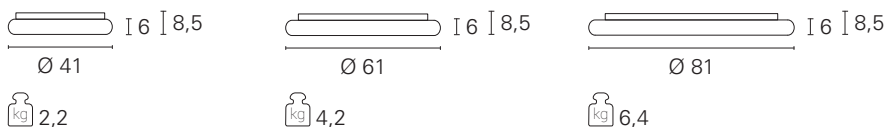

Ottiche / Optics

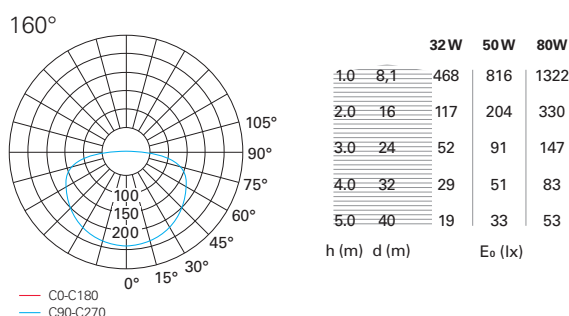

Corona Pendant
pag. 400



Corona Ceiling

modello model	versione version	codice code	colore finishing	Potenza / Flusso Effettivo Power / Lumen Output	CCT CCT	Alimentazione Power feed	IP IP
On / Off	Ceiling mounting - Ø 41	GRF02111	Bianco / White	32 W / 1920 lm	3000 K	220÷240 V - class I	IP20
	Ceiling mounting - Ø 61	GRF02211	Bianco / White	50 W / 3000 lm	3000 K	220÷240 V - class I	IP20
	Ceiling mounting - Ø 81	GRF02311	Bianco / White	80 W / 4800 lm	3000 K	220÷240 V - class I	IP20
Dimmerabile DALI / 1...10V / Push	Ceiling mounting - Ø 41	GRF02111DM	Bianco / White	32 W / 1920 lm	3000 K	220÷240 V - class I	IP20
	Ceiling mounting - Ø 61	GRF02211DM	Bianco / White	50 W / 3000 lm	3000 K	220÷240 V - class I	IP20
	Ceiling mounting - Ø 81	GRF02311DM	Bianco / White	80 W / 4800 lm	3000 K	220÷240 V - class I	IP20

Versioni dimmerabili: regolazione della luminosità 0/1 - 100 % - Dimmable versions: light regulation 0/1 - 100 %

Versioni dimmerabili / Dimmable versions

con controllo della luce wireless Bluetooth
wireless Bluetooth lighting control

versioni version	suffisso codice code suffix	nota note	esempio example
PAN Digital	PD	per ordinare la versione per smart application PAN Digital aggiungere PD alla fine del codice to order the version for smart application PAN Digital add PD to the end of the code	GRF-----PD
CASAMBI	CA	per ordinare la versione per smart application CASAMBI aggiungere CA alla fine del codice to order the version for smart application CASAMBI add CA to the end of the code	GRF-----CA

versioni Bluetooth per "smart application"; vedi dettagli alle pagine 8 - 9
Bluetooth versions for "smart application"; see details to pages 8 - 9

Kart Ceiling



220÷240 V

SMD Led



Kart è realizzata in alluminio verniciato bianco opaco ed è dotata di schermo diffondente in PMMA che permette di ottenere effetti di luce morbida e diffusa. La curvatura del corpo in alluminio si abbina perfettamente alla curvatura dello schermo interno in PMMA per realizzare un'unica forma dal design morbido e contemporaneo. La sorgente SMD LED ad alta efficienza è alimentata dal driver integrato nell'apparecchio e può essere On/Off o dimmerabile multifunzione con controllo 1...10V, Push, DALI. Kart è disponibile in diverse misure e potenze e si abbina alle versioni a sospensione. Disponibile nelle versioni dimmerabili "signal wireless" Bluetooth per reti mesh Pan Digital o Casambi.

Kart is made of matt white painted aluminium and is equipped with a PMMA diffusing screen which allows to obtain soft and diffused light effects. The curvature of the aluminium body perfectly matches the curvature of the internal PMMA screen to create a single shape with a soft and contemporary design. The high efficiency SMD LED source is powered by the driver integrated in the fixture and can be On/Off or dimmable multifunction 1...10 V, Push, DALI controlled. Kart is available in different sizes and powers and goes well with the suspension versions. Available in dimmable "wireless signal" Bluetooth versions for Pan Digital or Casambi mesh network.

Dimensioni / Dimensions

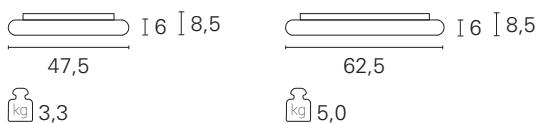

Ottiche / Optics

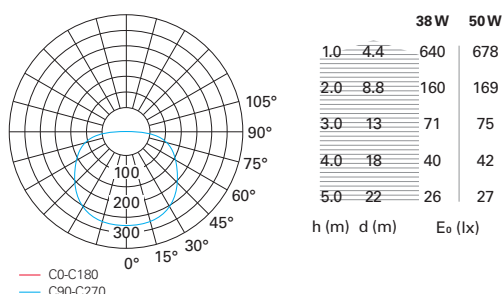

130°

Kart Pendant
pag. 402



Kart Ceiling

modello model	versione version	codice code	colore finishing	Potenza / Flusso Effettivo Power / Lumen Output	CCT CCT	Alimentazione Power feed	IP
On / Off	Ceiling mounting - 47,5 x 47,5	GRF03111	Bianco / White	38 W / 2290 lm	3000 K	220÷240 V - class I	IP20
	Ceiling mounting - 62,5 x 62,5	GRF03211	Bianco / White	50 W / 2450 lm	3000 K	220÷240 V - class I	IP20
Dimmerabile DALI / 1...10V / Push	Ceiling mounting - 47,5 x 47,5	GRF03111DM	Bianco / White	38 W / 2290 lm	3000 K	220÷240 V - class I	IP20
	Ceiling mounting - 62,5 x 62,5	GRF03211DM	Bianco / White	50 W / 2450 lm	3000 K	220÷240 V - class I	IP20

Versioni dimmerabili: regolazione della luminosità 0/1 - 100 % - Dimmable versions: light regulation 0/1 - 100 %

Versioni dimmerabili / Dimmable versions

con controllo della luce wireless Bluetooth
wireless Bluetooth lighting control

versioni version	suffisso codice code suffix	nota note	esempio example
PAN Digital	PD	per ordinare la versione per smart application PAN Digital aggiungere PD alla fine del codice to order the version for smart application PAN Digital add PD to the end of the code	GRF-----PD
CASAMBI	CA	per ordinare la versione per smart application CASAMBI aggiungere CA alla fine del codice to order the version for smart application CASAMBI add CA to the end of the code	GRF-----CA

versioni Bluetooth per "smart application"; vedi dettagli alle pagine 8 - 9
Bluetooth versions for "smart application"; see details to pages 8 - 9

Bike Ceiling



220÷240 V

SMD Led



Bike è realizzata in alluminio verniciato bianco opaco ed è completa di schermo inferiore in PMMA; permette di realizzare effetti di luce morbida e diffusa verso il basso ed è particolarmente indicata per l'illuminazione generale di ambienti di medie o grandi dimensioni. La sua forma ad anello permette di vedere il soffitto nella parte interna dell'apparecchio. La sorgente SMD LED ad alta efficienza è alimentata dal driver integrato nell'apparecchio che può essere On/Off o dimmerabile multifunzione con controllo 1...10V, Push, DALI. Bike è disponibile in diverse misure e potenze e si abbina alle corrispondenti versioni a sospensione. Disponibile nelle versioni dimmerabili "signal wireless" Bluetooth per reti mesh Pan Digital o Casambi.

Bike is made of matt white painted aluminium and is complete with lower PMMA screen; it allows to create soft and diffused down light effects and is particularly suitable for general lighting of medium or large environments. Its ring shape allows you to see the ceiling on the inside of the appliance. The high efficiency SMD LED source is powered by the driver integrated in the fixture which can be On/Off or dimmable multifunction 1...10 V, Push, DALI controlled. Bike is available in different sizes and powers and can be combined with the corresponding suspension versions. Available in dimmable "wireless signal" Bluetooth versions for Pan Digital or Casambi mesh network.

Dimensioni / Dimensions



Ottiche / Optics

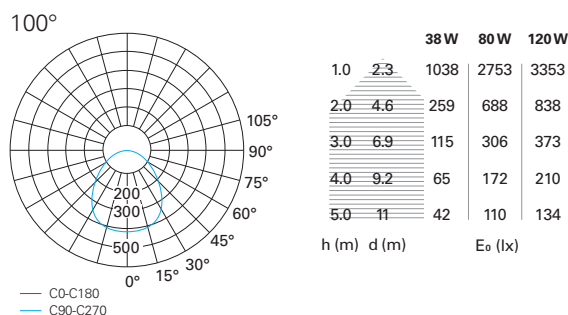

Bike Pendant
pag. 404



Bike Ceiling

modello model	versione version	codice code	colore finishing	Potenza / Flusso Effettivo Power / Lumen Output	CCT CCT	Alimentazione Power feed	IP IP
On / Off	Ceiling mounting - Ø 50	GRF04111	Bianco / White	38 W / 2280 lm	3000 K	220÷240 V - class I	IP20
	Ceiling mounting - Ø 80	GRF04211	Bianco / White	80 W / 4800 lm	3000 K	220÷240 V - class I	IP20
	Ceiling mounting - Ø 110	GRF04311	Bianco / White	120 W / 7200 lm	3000 K	220÷240 V - class I	IP20
Dimmerabile DALI / 1...10 V / Push	Ceiling mounting - Ø 50	GRF04111DM	Bianco / White	38 W / 2280 lm	3000 K	220÷240 V - class I	IP20
	Ceiling mounting - Ø 80	GRF04211DM	Bianco / White	80 W / 4800 lm	3000 K	220÷240 V - class I	IP20
	Ceiling mounting - Ø 110	GRF04311DM	Bianco / White	120 W / 7200 lm	3000 K	220÷240 V - class I	IP20

Versioni dimmerabili: regolazione della luminosità 0/1 - 100 % - Dimmable versions: light regulation 0/1 - 100 %

Versioni dimmerabili / Dimmable versions



con controllo della luce wireless Bluetooth
wireless Bluetooth lighting control

versioni version	suffisso codice code suffix	nota note	esempio example
PAN Digital	PD	per ordinare la versione per smart application PAN Digital aggiungere PD alla fine del codice to order the version for smart application PAN Digital add PD to the end of the code	GRF-----PD
CASAMBI	CA	per ordinare la versione per smart application CASAMBI aggiungere CA alla fine del codice to order the version for smart application CASAMBI add CA to the end of the code	GRF-----CA

versioni Bluetooth per "smart application"; vedi dettagli alle pagine 8 - 9
Bluetooth versions for "smart application"; see details to pages 8 - 9

Penny Ceiling



⊕ 220÷240 V SMD Led  

Penny è realizzata in alluminio verniciato bianco opaco e si caratterizza per il suo grande schermo inferiore in PMMA che si illumina in modo perfettamente uniforme; utilizzando Penny si ottengono effetti di luce morbida e diffusa verso il basso con emissioni fino a 12700 lumen nella versione di maggior diametro; Penny è quindi particolarmente indicata per illuminare grandi ambienti con luce uniforme, perfettamente distribuita e senza ombre dure. Equipaggiata con sorgenti SMD LED ad alta efficienza, Penny è completa di driver integrati nel corpo dell'apparecchio ed è disponibile con controllo On/Off o dimmerabile multifunzione 1...10V, Push, DALI. Penny è disponibile in diverse misure e potenze e si abbina alle corrispondenti versioni a sospensione. Disponibile nelle versioni dimmerabili "signal wireless" Bluetooth per reti mesh Pan Digital o Casambi.

Penny is aluminium ceiling mounted luminaire in matt white painted color; it is characterized by its large PMMA lower screen which lights up perfectly evenly; by using Penny soft and diffused down light effects are obtained with emissions up to 12700 lumens in the larger diameter version; Penny is therefore particularly suitable for illuminating large rooms with uniform and perfectly distributed light without harsh shadows. Equipped with high efficiency SMD LED sources, Penny is complete with drivers integrated in the body of the fixture and is available with On/Off control or dimmable multifunction 1...10 V, Push, DALI. Penny is available in different sizes and powers and can be combined with the corresponding suspension versions. Available in dimmable "wireless signal" Bluetooth versions for Pan Digital or Casambi mesh network.

Dimensioni / Dimensions

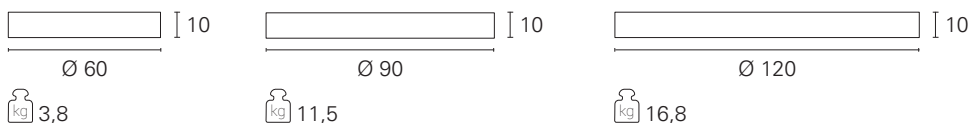

Ottiche / Optics

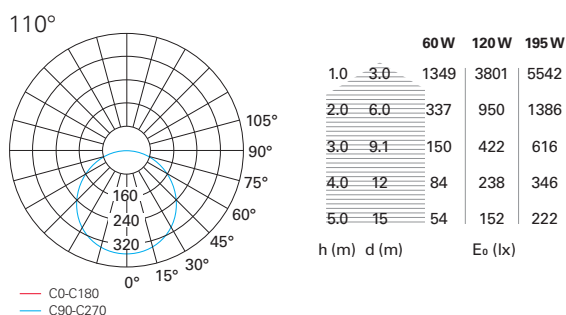

Penny Pendant
pag. 408



Penny Ceiling

modello model	versione version	codice code	colore finishing	Potenza / Flusso Effettivo Power / Lumen Output	CCT CCT	Alimentazione Power feed	IP IP
On / Off	Ceiling mounting - Ø 60	GRF05111	Bianco / White	60 W / 3900 lm	3000 K	220÷240 V - class I	IP20
	Ceiling mounting - Ø 90	GRF05211	Bianco / White	120 W / 7800 lm	3000 K	220÷240 V - class I	IP20
	Ceiling mounting - Ø 120	GRF05311	Bianco / White	195 W / 12675 lm	3000 K	220÷240 V - class I	IP20
Dimmerabile DALI / 1...10V / Push	Ceiling mounting - Ø 60	GRF05111DM	Bianco / White	60 W / 3900 lm	3000 K	220÷240 V - class I	IP20
	Ceiling mounting - Ø 90	GRF05211DM	Bianco / White	120 W / 7800 lm	3000 K	220÷240 V - class I	IP20
	Ceiling mounting - Ø 120	GRF05311DM	Bianco / White	195 W / 12675 lm	3000 K	220÷240 V - class I	IP20

Versioni dimmerabili: regolazione della luminosità 0/1 - 100 % - Dimmable versions: light regulation 0/1 - 100 %

Versioni dimmerabili / Dimmable versions

con controllo della luce wireless Bluetooth
wireless Bluetooth lighting control

versioni version	suffisso codice code suffix	nota note	esempio example
PAN Digital	PD	per ordinare la versione per smart application PAN Digital aggiungere PD alla fine del codice to order the version for smart application PAN Digital add PD to the end of the code	GRF-----PD
CASAMBI	CA	per ordinare la versione per smart application CASAMBI aggiungere CA alla fine del codice to order the version for smart application CASAMBI add CA to the end of the code	GRF-----CA

versioni Bluetooth per "smart application"; vedi dettagli alle pagine 8 - 9
Bluetooth versions for "smart application"; see details to pages 8 - 9

Play



220÷240 V

SMD Led



Play è realizzata in alluminio verniciato bianco opaco o nero opaco ed è dotata di schermo opalino diffondente in PMMA. Grazie alle sorgenti SMD LED integrate nel corpo dell'apparecchio, lo schermo inferiore si illumina in modo perfettamente uniforme; Play permette di ottenere effetti di luce morbida e diffusa verso il basso ed è quindi particolarmente indicata per illuminare gli ambienti con luce uniforme, perfettamente distribuita e priva di ombre dure. Play è completa di driver integrati nel corpo dell'apparecchio ed è disponibile nelle versioni con controllo On/Off o con controllo dimmerabile 1...10V, Push, DALI. Completano la gamma le versioni per luce in emergenza permanente con 1 ora di autonomia, tempo di accensione 0,5 sec. e tempo di ricarica 24 h. Disponibile nelle versioni dimmerabili "signal wireless" Bluetooth per reti mesh Pan Digital o Casambi.

Play is an aluminium ceiling mounted luminaire in matt white or matt black color painted, equipped with a diffusing opal PMMA screen. Thanks to the SMD LED sources integrated in the body of the device, the lower screen lights up perfectly evenly; Play allows to obtain soft and diffused down light effects and is therefore particularly suitable for illuminating indoor ambients with uniform light, perfectly distributed and free of harsh shadows. Play is complete with drivers integrated into the body of the device and is available in versions OnOff controlled or dimmable 1 ... 10V, Push, DALI controlled. The range is completed by versions for permanent emergency light with 1 hour autonomy, ignition time 0.5 sec. and recharging time 24 h. Available in dimmable "wireless signal" Bluetooth versions for Pan Digital or Casambi mesh network.

Dimensioni / Dimensions

Ceiling Ø 41 cm.

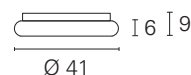
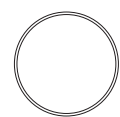

Ø 41

kg 3,3

Ceiling Ø 61 cm.

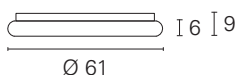
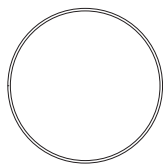

Ø 61

kg 4,8

Ceiling Ø 81 cm.

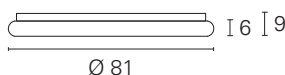
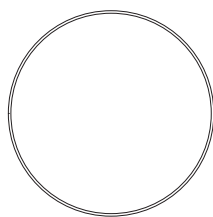

Ø 81

kg 7,7

Ottiche / Optics

110°

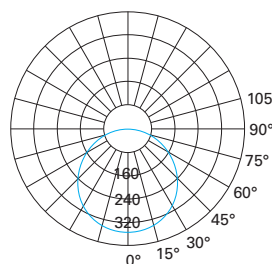

— C0-C180
— C90-C270

		38 W	62 W	100 W
1.0	3.0	869	1624	3231
2.0	6.1	217	406	808
3.0	9.1	97	180	359
4.0	12	54	102	202
5.0	15	35	65	129
h (m)	d (m)	E ₀ (lx)		

Play

modello model	versione version	codice code	colore finishing	Potenza / Flusso Effettivo Power / Lumen Output	CCT CCT	Alimentazione Power feed	IP IP
On / Off	Ceiling mounting - Ø 41	GRF11111	Bianco / White	38 W / 2280 lm	3000 K	220÷240 V - class I	IP20
	Ceiling mounting - Ø 41	GRF11121	Nero / Black	38 W / 2280 lm	3000 K	220÷240 V - class I	IP20
	Ceiling mounting - Ø 61	GRF11211	Bianco / White	62 W / 3720 lm	3000 K	220÷240 V - class I	IP20
	Ceiling mounting - Ø 61	GRF11221	Nero / Black	62 W / 3720 lm	3000 K	220÷240 V - class I	IP20
	Ceiling mounting - Ø 81	GRF11311	Bianco / White	100 W / 6000 lm	3000 K	220÷240 V - class I	IP20
	Ceiling mounting - Ø 81	GRF11321	Nero / Black	100 W / 6000 lm	3000 K	220÷240 V - class I	IP20
Dimmerabile DALI / 1...10 V / Push	Ceiling mounting - Ø 41	GRF11111DM	Bianco / White	38 W / 2280 lm	3000 K	220÷240 V - class I	IP20
	Ceiling mounting - Ø 41	GRF11121DM	Nero / Black	38 W / 2280 lm	3000 K	220÷240 V - class I	IP20
	Ceiling mounting - Ø 61	GRF11211DM	Bianco / White	62 W / 3720 lm	3000 K	220÷240 V - class I	IP20
	Ceiling mounting - Ø 61	GRF11221DM	Nero / Black	62 W / 3720 lm	3000 K	220÷240 V - class I	IP20
	Ceiling mounting - Ø 81	GRF11311DM	Bianco / White	100 W / 6000 lm	3000 K	220÷240 V - class I	IP20
	Ceiling mounting - Ø 81	GRF11321DM	Nero / Black	100 W / 6000 lm	3000 K	220÷240 V - class I	IP20
Emergenza 1 h.	Ceiling mounting - Ø 41	GRF11111H1	Bianco / White	in emergency mode 450 lm	3000 K	220÷240 V - class I	IP20
	Ceiling mounting - Ø 41	GRF11121H1	Nero / Black	in emergency mode 450 lm	3000 K	220÷240 V - class I	IP20
	Ceiling mounting - Ø 61	GRF11211H1	Bianco / White	in emergency mode 400 lm	3000 K	220÷240 V - class I	IP20
	Ceiling mounting - Ø 61	GRF11221H1	Nero / Black	in emergency mode 400 lm	3000 K	220÷240 V - class I	IP20
	Ceiling mounting - Ø 81	GRF11311H1	Bianco / White	in emergency mode 450 lm	3000 K	220÷240 V - class I	IP20
	Ceiling mounting - Ø 81	GRF11321H1	Nero / Black	in emergency mode 450 lm	3000 K	220÷240 V - class I	IP20

Versioni dimmerabili: regolazione della luminosità 0/1 - 100 % - Dimmable versions: light regulation 0/1 - 100 %

Versioni dimmerabili / Dimmable versions

con controllo della luce wireless Bluetooth
wireless Bluetooth lighting control

versioni version	suffisso codice code suffix	nota note	esempio example
PAN Digital	PD	per ordinare la versione per smart application PAN Digital aggiungere PD alla fine del codice to order the version for smart application PAN Digital add PD to the end of the code	GRF-----PD
CASAMBI	CA	per ordinare la versione per smart application CASAMBI aggiungere CA alla fine del codice to order the version for smart application CASAMBI add CA to the end of the code	GRF-----CA

versioni Bluetooth per "smart application"; vedi dettagli alle pagine 8 - 9
Bluetooth versions for "smart application"; see details to pages 8 - 9

Dama

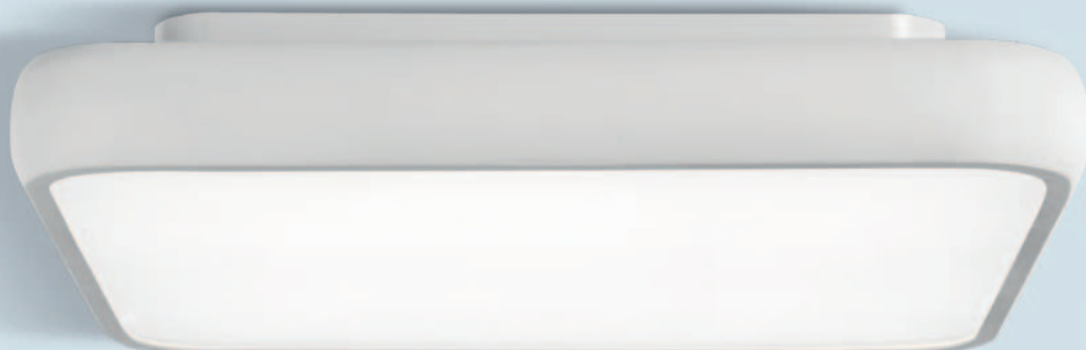

220÷240 V

SMD Led



Di forma quadrata, Dama è realizzata in alluminio verniciato bianco opaco o nero opaco; è dotata di schermo opalino diffondente in PMMA e, grazie alle sorgenti SMD LED integrate nel corpo dell'apparecchio, si illumina in modo perfettamente uniforme; Dama permette di ottenere effetti di luce morbida e diffusa verso il basso ed è quindi particolarmente indicata per illuminare gli ambienti con luce uniforme, perfettamente distribuita e priva di ombre dure. Dama è completa di driver integrati nel corpo dell'apparecchio ed è disponibile nelle versioni con controllo On/Off o con controllo dimmerabile 1...10V, Push, DALI.

Completano la gamma le versioni per luce in emergenza permanente con 1 ora di autonomia, tempo di accensione 0,5 sec. e tempo di ricarica 24 h. Disponibile nelle versioni dimmerabili "signal wireless" Bluetooth per reti mesh Pan Digital o Casambi.

Designed in a square shape, Dama is made of matt white or matt black painted aluminium; it is equipped with an opal diffusing screen in PMMA and, thanks to the SMD LED sources integrated in the body of the luminaire, it lights up perfectly evenly; Dama allows to obtain soft and diffused down light effects and is therefore particularly suitable for illuminating indoor ambients with uniform light, perfectly distributed and free of harsh shadows. Dama is complete with drivers integrated into the body of the device and is available in versions On/Off controlled or dimmable 1...10 V, Push, DALI controlled. The range is completed by versions for permanent emergency light with 1 hour autonomy, ignition time 0.5 sec. and charging time 24 h. Available in dimmable "wireless signal" Bluetooth versions for Pan Digital or Casambi mesh network.

Dimensioni / Dimensions

Ceiling l. 42 cm.

Ceiling l. 64 cm.

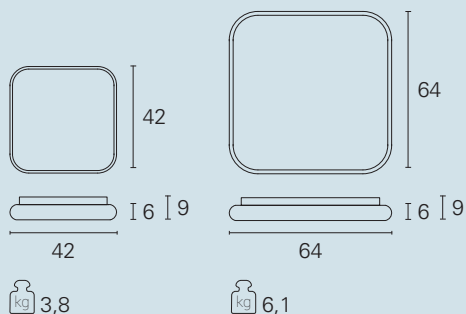

Ottiche / Optics

110°

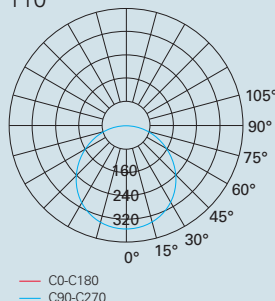

		38 W	62 W
1.0	3.0	849	1439
2.0	6.1	212	360
3.0	9.1	94	160
4.0	12	53	90
5.0	15	34	58
h (m)	d (m)	E ₀ (lx)	

Dama

modello model	versione version	codice code	colore finishing	Potenza / Flusso Effettivo Power / Lumen Output	CCT CCT	Alimentazione Power feed	IP IP
On / Off	Ceiling mounting - 42 x 42	GRF12111	Bianco / White	38 W / 2280 lm	3000 K	220÷240 V - class I	IP20
	Ceiling mounting - 42 x 42	GRF12121	Nero / Black	38 W / 2280 lm	3000 K	220÷240 V - class I	IP20
	Ceiling mounting - 64 x 64	GRF12211	Bianco / White	62 W / 3720 lm	3000 K	220÷240 V - class I	IP20
	Ceiling mounting - 64 x 64	GRF12221	Nero / Black	62 W / 3720 lm	3000 K	220÷240 V - class I	IP20
Dimmerabile DALI / 1...10 V / Push	Ceiling mounting - 42 x 42	GRF12111DM	Bianco / White	38 W / 2280 lm	3000 K	220÷240 V - class I	IP20
	Ceiling mounting - 42 x 42	GRF12121DM	Nero / Black	38 W / 2280 lm	3000 K	220÷240 V - class I	IP20
	Ceiling mounting - 64 x 64	GRF12211DM	Bianco / White	62 W / 3720 lm	3000 K	220÷240 V - class I	IP20
Emergenza 1 h.	Ceiling mounting - 64 x 64	GRF12221DM	Nero / Black	62 W / 3720 lm	3000 K	220÷240 V - class I	IP20
	Ceiling mounting - 42 x 42	GRF12111H1	Bianco / White	in emergency mode 450 lm	3000 K	220÷240 V - class I	IP20
	Ceiling mounting - 42 x 42	GRF12121H1	Nero / Black	in emergency mode 450 lm	3000 K	220÷240 V - class I	IP20
	Ceiling mounting - 64 x 64	GRF12211H1	Bianco / White	in emergency mode 400 lm	3000 K	220÷240 V - class I	IP20
Ceiling mounting - 64 x 64	GRF12221H1	Nero / Black	in emergency mode 400 lm	3000 K	220÷240 V - class I	IP20	

Versioni dimmerabili: regolazione della luminosità 0/1 - 100 % - Dimmable versions: light regulation 0/1 - 100 %

Versioni dimmerabili / Dimmable versions

con controllo della luce wireless Bluetooth
wireless Bluetooth lighting control

versioni version	suffisso codice code suffix	nota note	esempio example
PAN Digital	PD	per ordinare la versione per smart application PAN Digital aggiungere PD alla fine del codice to order the version for smart application PAN Digital add PD to the end of the code	GRF-----PD
CASAMBI	CA	per ordinare la versione per smart application CASAMBI aggiungere CA alla fine del codice to order the version for smart application CASAMBI add CA to the end of the code	GRF-----CA

versioni Bluetooth per "smart application"; vedi dettagli alle pagine 8 - 9
Bluetooth versions for "smart application"; see details to pages 8 - 9

Young

⊕ 220÷240 V SMD Led

Young è realizzata in alluminio verniciato bianco opaco e si caratterizza per il ridotto spessore del corpo che la rende gradevole anche quando installata in ambienti con soffitti molto bassi; è dotata di schermo opalino diffondente in PMMA e, grazie alle sorgenti SMD LED integrate nel corpo dell'apparecchio, si illumina in modo perfettamente uniforme; Young permette di ottenere effetti di luce morbida e diffusa verso il basso, perfettamente distribuita e priva di ombre dure. Young è completa di driver integrati nel corpo dell'apparecchio.

Young is made of matt white painted aluminium and is characterized by the reduced thickness of the body which makes it pleasant even when installed in rooms with very low ceilings; it is equipped with an opal diffusing screen in PMMA and, thanks to the SMD LED sources integrated in the body of the luminaire, it lights up perfectly evenly; Young allows to obtain soft and diffused down light effects perfectly distributed and free of hard shadows. Young is complete with drivers integrated into the body of the device.



Dimensioni / Dimensions

Wall / Ceiling Ø 22,5 cm.

Wall / Ceiling Ø 30 cm.

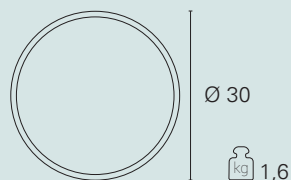
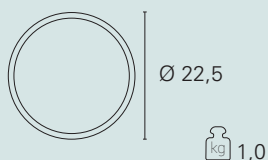

Ottiche / Optics

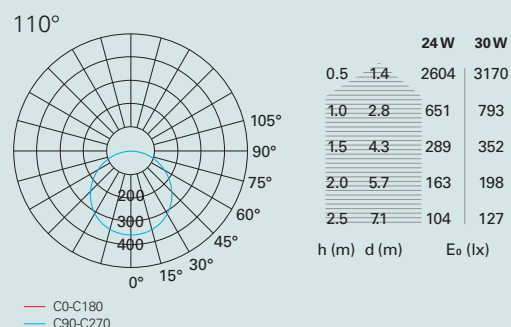

Young

Versione Model	Codice Code	Colore Finishing	Potenza / Flusso Effettivo Power / Lumen Output	CCT CCT	Sorgente Source	Alimentazione Power feeding	Classe energetica Energy Label	IP IP
Wall / Ceiling mounting - Ø 22,5 cm.	SOP03211	Bianco / White	24 W / 1830 lm	3000 K	SMD LED	220÷240 V - class II	LED	IP20
Wall / Ceiling mounting - Ø 22,5 cm.	SOP03212	Bianco / White	24 W / 1880 lm	4000 K	SMD LED	220÷240 V - class II	LED	IP20
Wall / Ceiling mounting - Ø 30 cm.	SOP03311	Bianco / White	30 W / 2230 lm	3000 K	SMD LED	220÷240 V - class II	LED	IP20
Wall / Ceiling mounting - Ø 30 cm.	SOP03312	Bianco / White	30 W / 2400 lm	4000 K	SMD LED	220÷240 V - class II	LED	IP20

Gipsy

⊕ 220÷240 V SMD Led

Gipsy è realizzata in gesso bianco ed è verniciabile dall'utilizzatore anche dopo l'installazione. Il corpo è ridotto nello spessore ne permette l'installazione anche in ambienti con soffitti particolarmente bassi; è dotata di schermo opalino diffondente in PMMA e, grazie alle sorgenti SMD LED integrate nel corpo dell'apparecchio, si illumina in modo perfettamente uniforme; Gipsy permette di ottenere effetti di luce morbida e diffusa verso il basso, perfettamente distribuita e priva di ombre dure. Gipsy è completa di driver integrati nel corpo dell'apparecchio.

Gipsy is made of white plaster and is paintable also after the installation. The body is reduced in thickness, allowing it to be installed even in rooms with particularly low ceilings; it is equipped with an opal diffusing screen in PMMA and, thanks to the SMD LED sources integrated in the body of the luminaire, it illuminates perfectly evenly; Gipsy allows to obtain soft and diffused downlight effects, perfectly distributed and free of hard shadows. Gipsy is complete with drivers integrated into the body of the device.



Dimensioni / Dimensions

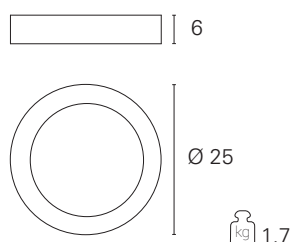

Gesso
Plaster



Gipsy

Versione Model	Codice Code	Colore Finishing	Potenza / Flusso Effettivo Power / Lumen Output	CCT CCT	Sorgente Source	Alimentazione Power feeding	Classe energetica Energy Label	IP IP
Wall / Ceiling mounting - Ø 25 cm.	PLA10122	Bianco / White	15 W / 1350 lm	3000 K	SMD LED	220÷240 V - class I	LED	IP20

Orion



⊕ 220÷240 V SMD Led

Orion è costituita da una struttura in metallo verniciato bianco sul quale si monta uno schermo opalino in PMMA, di forma convessa e realizzato in un unico pezzo. Orion è equipaggiata con sorgenti LED SMD e il driver è integrato nel corpo dell'apparecchio; si installa sia a soffitto che a parete ed indicata per illuminare gli ambienti con luce diffusa.

Orion is realized with a white painted metal structure on which is mounted an opal PMMA screen, convex in shape and made in one piece. Orion is equipped with SMD LED sources and the driver is integrated into the body of the fixtures; it can be installed both on the ceiling and on the wall and is suitable for illuminating rooms with diffused light.



Dimensioni / Dimensions

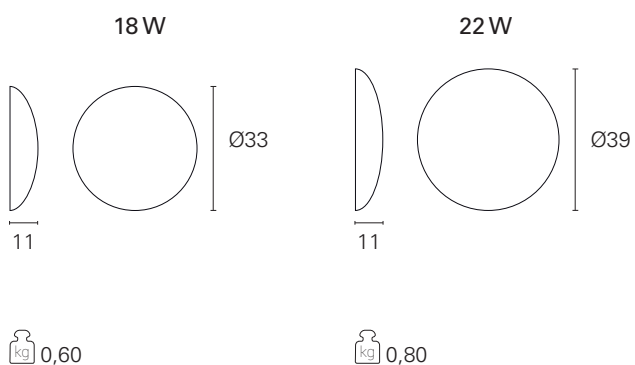

Ottiche / Optics

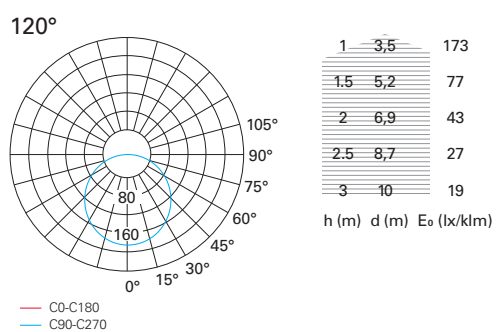

Orion

modello model	versione version	potenza power	codice code	temp. di colore light temperature	CRI CRI	flusso apparecchio light output	Alimentazione Power feeding	ottica optic	colore colour
Rounded	On/Off	18 W	PLA00009	3000 K	> 80	1170 lm	220÷240 V - class I	120°	bianco / white
			PLA00012	4000 K	> 80	1220 lm	220÷240 V - class I	120°	bianco / white
		22 W	PLA00010	3000 K	> 80	1430 lm	220÷240 V - class I	120°	bianco / white
			PLA00013	4000 K	> 80	1500 lm	220÷240 V - class I	120°	bianco / white

Sospensioni

Pendants



Hoop Pendant
p.398

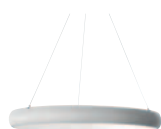

Corona Pendant
p.400



Kart Pendant
p.402



Bike Pendant
p.404



Penny Pendant
p.408



Giove
p.416



Saturno
p.418

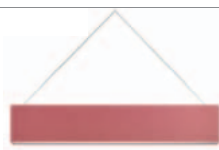

Urano
p.422



Etna
p.424



Archer
p.426



Stek
p.428



Lupin Pendant
p.430



Cross
p.434



Lunar Pendant
p.436



Elmet
p.438



Medea
p.440



Urban Pendant
p.442



Bay
p.444



Bond
p.446



Bugle
p.448



Minimal
p.450



Brio
p.452



Rod
p.454

Hoop Pendant



220÷240 V

SMD Led



Hoop è una sospensione realizzata in alluminio verniciato bianco opaco ed equipaggiata con schermo diffondente in PMMA. Si installa a sospensione mediante tre cavi in acciaio rivestiti con guaina trasparente e regolabili in altezza grazie ai tre "grip locks" posizionati sul corpo dell'apparecchio. Grazie a Hoop si ottengono effetti di luce morbida e diffusa adatti ad illuminare gli ambienti in modo confortevole e senza ombre dure. Il driver incluso può essere On/Off o dimmerabile multifunzione con controllo 1...10V, Push, DALI, ed alimenta una sorgente LED SMD ad alta efficienza. Hoop è disponibile nella versione a sospensione in diverse misure e potenze, e si completa con le analoghe versioni a plafone. Disponibile nelle versioni dimmerabili "signal wireless" Bluetooth per reti mesh Pan Digital o Casambi.

Hoop is a pendant made of matt white painted aluminium and equipped with a PMMA diffusing screen. It is suspended with three steel cables covered with transparent sheath and adjustable in height thanks to the three "grip locks" positioned on the body of the appliance. Thanks to Hoop, soft and diffused light effects are obtained, suitable for illuminating indoor ambients comfortably and without harsh shadows. The driver included can be On/Off or dimmable multifunction 1... 10V, Push, DALI controlled, and feeds a high efficiency SMD LED source. Hoop is available in the pendant version in different sizes and powers and is completed with the similar ceiling versions. Available in dimmable "wireless signal" Bluetooth versions for Pan Digital or Casambi mesh network.

Dimensioni / Dimensions

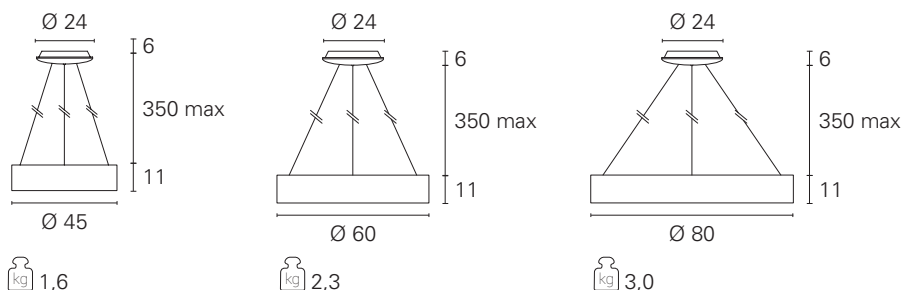

Ottiche / Optics

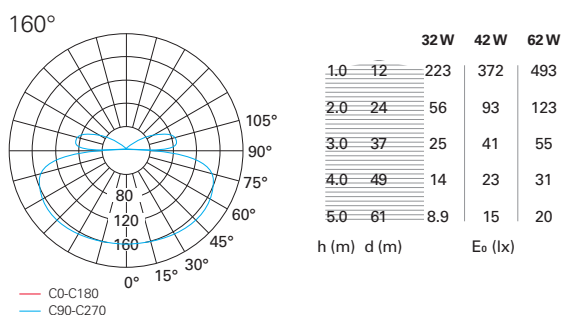

Hoop Ceiling
pag. 378



Hoop Pendant

modello model	versione version	codice code	colore finishing	Potenza / Flusso Effettivo Power / Lumen Output	CCT CCT	Alimentazione Power feed	IP IP
On / Off	Pendant - Ø 45	SOS00113	Bianco / White	32 W / 1920 lm	3000 K	220÷240 V - class I	IP20
	Pendant - Ø 60	SOS00116	Bianco / White	42 W / 2520 lm	3000 K	220÷240 V - class I	IP20
	Pendant - Ø 80	SOS00119	Bianco / White	62 W / 3720 lm	3000 K	220÷240 V - class I	IP20
Dimmerabile DALI / 1...10 V / Push	Pendant - Ø 45	SOS00113DA	Bianco / White	32 W / 1920 lm	3000 K	220÷240 V - class I	IP20
	Pendant - Ø 60	SOS00116DA	Bianco / White	42 W / 2520 lm	3000 K	220÷240 V - class I	IP20
	Pendant - Ø 80	SOS00119DA	Bianco / White	62 W / 3720 lm	3000 K	220÷240 V - class I	IP20

Versioni dimmerabili: regolazione della luminosità 0/1 - 100 % - Dimmable versions: light regulation 0/1 - 100 %

Versioni dimmerabili / Dimmable versions

con controllo della luce wireless Bluetooth
wireless Bluetooth lighting control

versioni version	suffisso codice code suffix	nota note	esempio example
PAN Digital	PD	per ordinare la versione per smart application PAN Digital aggiungere PD alla fine del codice to order the version for smart application PAN Digital add PD to the end of the code	SOS-----PD
CASAMBI	CA	per ordinare la versione per smart application CASAMBI aggiungere CA alla fine del codice to order the version for smart application CASAMBI add CA to the end of the code	SOS-----CA

versioni Bluetooth per "smart application"; vedi dettagli alle pagine 8 - 9
Bluetooth versions for "smart application"; see details to pages 8 - 9

Corona Pendant



220÷240 V

SMD Led



Corona è realizzata in alluminio verniciato bianco opaco ed è dotata di schermo diffondente in PMMA per effetti di luce morbida e diffusa. La curvatura del corpo in alluminio si abbina perfettamente alla curvatura dello schermo interno in PMMA e realizza un'unica forma dal design morbido e contemporaneo. Corona si installa a sospensione mediante tre cavi in acciaio rivestiti con guaina trasparente e regolabili in altezza grazie ai tre "grip locks" posizionati sul corpo dell'apparecchio. La sorgente SMD LED ad alta efficienza è alimentata dal driver integrato nell'apparecchio e può essere On/Off o dimmerabile multifunzione con controllo 1...10V, Push, DALI. Corona è disponibile in diverse misure e potenze e si abbina alle versioni per l'installazione a plafone. Disponibile nelle versioni dimmerabili "signal wireless" Bluetooth per reti mesh Pan Digital o Casambi.

Corona is made of matt white painted aluminium and is equipped with a diffusing screen in PMMA for soft and diffused light effects. The curvature of the aluminium body perfectly matches the curvature of the internal PMMA screen and creates a unique shape with a soft and contemporary design. Corona is installed in suspension by means of three steel cables covered with transparent sheath and adjustable in height thanks to the three "grip locks" positioned on the body of the appliance. The high efficiency SMD LED source is powered by the driver integrated in the fixture and can be On/Off or dimmable multifunction with 1... 10V, Push, DALI control. Corona is available in different sizes and powers and is combined with versions for ceiling installation. Available in dimmable "wireless signal" Bluetooth versions for Pan Digital or Casambi mesh network.



Dimensioni / Dimensions

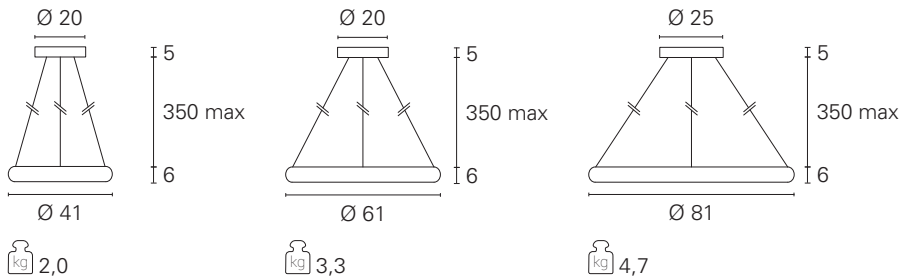

Ottiche / Optics

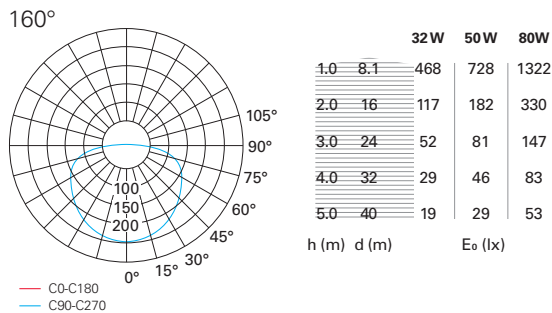

Corona Ceiling
pag. 380



Corona Pendant

modello model	versione version	codice code	colore finishing	Potenza / Flusso Effettivo Power / Lumen Output	CCT CCT	Alimentazione Power feed	IP IP
On / Off	Pendant - Ø 41	GRF07111	Bianco / White	32 W / 1920 lm	3000 K	220÷240 V - class I	IP20
	Pendant - Ø 61	GRF07211	Bianco / White	50 W / 3000 lm	3000 K	220÷240 V - class I	IP20
	Pendant - Ø 81	GRF07311	Bianco / White	80 W / 4800 lm	3000 K	220÷240 V - class I	IP20
Dimmerabile	Pendant - Ø 41	GRF07111DM	Bianco / White	32 W / 1920 lm	3000 K	220÷240 V - class I	IP20
DALI / 1...10V / Push	Pendant - Ø 61	GRF07211DM	Bianco / White	50 W / 3000 lm	3000 K	220÷240 V - class I	IP20
	Pendant - Ø 81	GRF07311DM	Bianco / White	80 W / 4800 lm	3000 K	220÷240 V - class I	IP20

Versioni dimmerabili: regolazione della luminosità 0/1 - 100 % - Dimmable versions: light regulation 0/1 - 100 %

Versioni dimmerabili / Dimmable versions

con controllo della luce wireless Bluetooth
wireless Bluetooth lighting control

versioni version	suffisso codice code suffix	nota note	esempio example
PAN Digital	PD	per ordinare la versione per smart application PAN Digital aggiungere PD alla fine del codice to order the version for smart application PAN Digital add PD to the end of the code	GRF-----PD
CASAMBI	CA	per ordinare la versione per smart application CASAMBI aggiungere CA alla fine del codice to order the version for smart application CASAMBI add CA to the end of the code	GRF-----CA

versioni Bluetooth per "smart application"; vedi dettagli alle pagine 8 - 9
Bluetooth versions for "smart application"; see details to pages 8 - 9

Kart Pendant

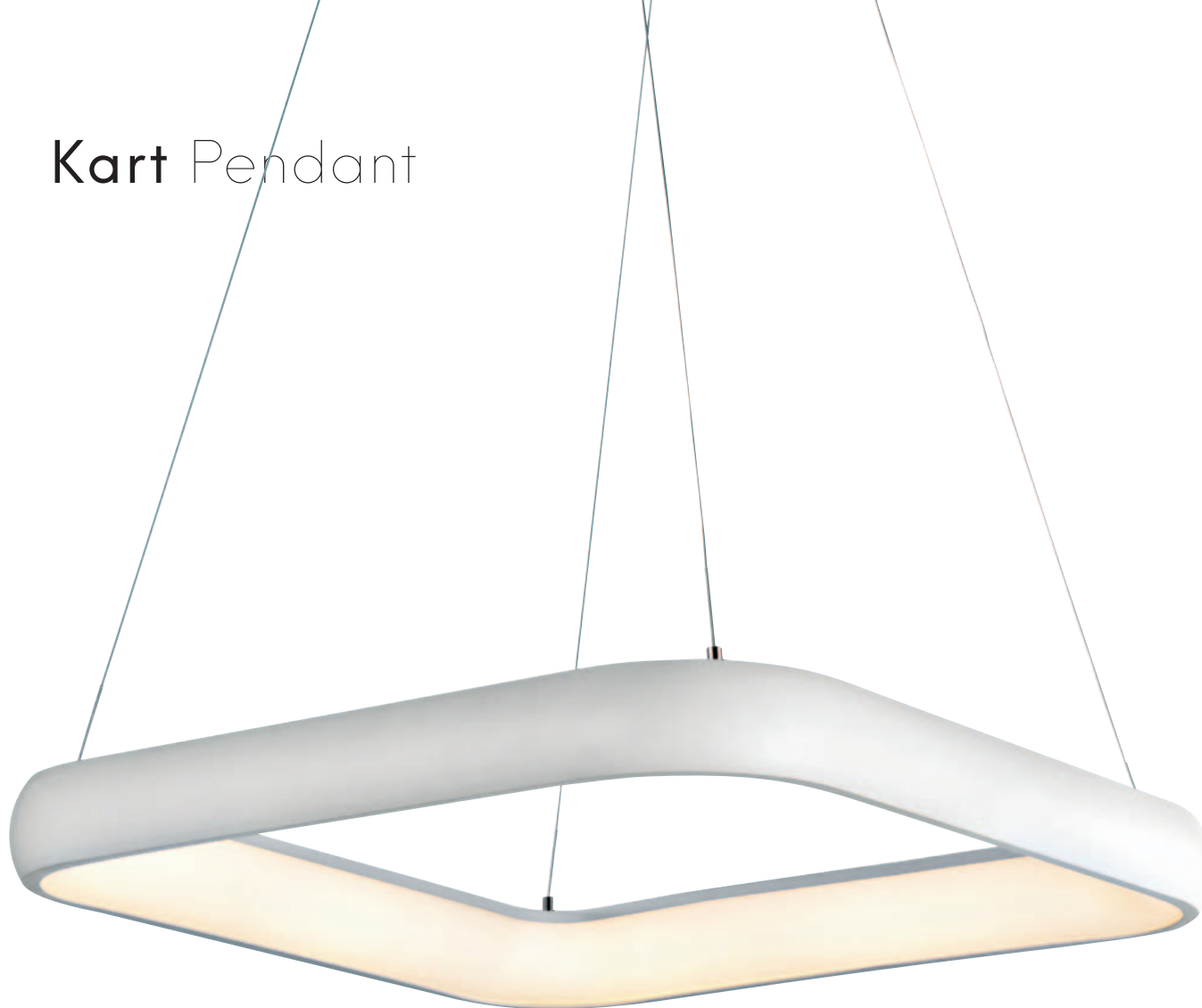

⊕ 220÷240 V SMD Led  

Kart è realizzata in alluminio verniciato bianco opaco ed è dotata di schermo diffondente in PMMA che permette di ottenere effetti di luce morbida e diffusa. La curvatura del corpo in alluminio si abbina perfettamente alla curvatura dello schermo interno in PMMA per realizzare un'unica forma dal design morbido e contemporaneo. Kart si installa a sospensione mediante quattro cavi in acciaio rivestiti con guaina trasparente e regolabili in altezza grazie ai quattro "grip locks" posizionati sul corpo dell'apparecchio. La sorgente SMD LED ad alta efficienza è alimentata dal driver integrato nell'apparecchio e può essere On/Off o dimmerabile multifunzione con controllo 1...10V, Push, DALI. Kart è disponibile in diverse misure e potenze e si abbina alle versioni per installazione a soffitto. Disponibile nelle versioni dimmerabili "signal wireless" Bluetooth per reti mesh Pan Digital o Casambi.

Kart is made of matt white painted aluminium and is equipped with a PMMA diffusing screen which allows to obtain soft and diffused light effects. The curvature of the aluminium body perfectly matches the curvature of the internal PMMA screen to create a single shape with a soft and contemporary design. Kart is installed in suspension by means of four steel cables covered with transparent sheath and adjustable in height thanks to the four "grip locks" positioned on the body of the appliance. The high efficiency SMD LED source is powered by the driver integrated in the fixture and can be On / Off or dimmable multifunction with 1...10V, Push, DALI control. Kart is available in different sizes and powers and matches the versions for ceiling installation. Available in dimmable "wireless signal" Bluetooth versions for Pan Digital or Casambi mesh network.

Dimensioni / Dimensions

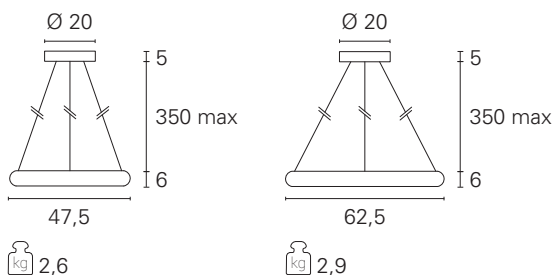

Ottiche / Optics

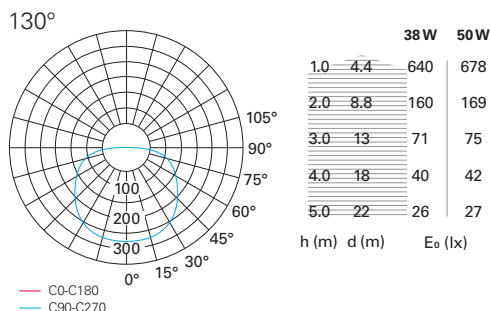

Kart Ceiling
pag. 382



Kart Pendant

modello model	versione version	codice code	colore finishing	Potenza / Flusso Effettivo Power / Lumen Output	CCT CCT	Alimentazione Power feed	IP IP
On / Off	Pendant - 47,5 x 47,5	GRF08111	Bianco / White	38 W / 2280 lm	3000 K	220÷240 V - class I	IP20
	Pendant - 62,5 x 62,5	GRF08211	Bianco / White	50 W / 3000 lm	3000 K	220÷240 V - class I	IP20
DALI / 1...10V / Push	Pendant - 47,5 x 47,5	GRF08111DM	Bianco / White	38 W / 2280 lm	3000 K	220÷240 V - class I	IP20
	Pendant - 62,5 x 62,5	GRF08211DM	Bianco / White	50 W / 3000 lm	3000 K	220÷240 V - class I	IP20

Versioni dimmerabili: regolazione della luminosità 0/1 - 100 % - Dimmable versions: light regulation 0/1 - 100 %

Versioni dimmerabili / Dimmable versions

con controllo della luce wireless Bluetooth
wireless Bluetooth lighting control

versioni version	suffisso codice code suffix	nota note	esempio example
PAN Digital	PD	per ordinare la versione per smart application PAN Digital aggiungere PD alla fine del codice to order the version for smart application PAN Digital add PD to the end of the code	GRF-----PD
CASAMBI	CA	per ordinare la versione per smart application CASAMBI aggiungere CA alla fine del codice to order the version for smart application CASAMBI add CA to the end of the code	GRF-----CA

versioni Bluetooth per "smart application"; vedi dettagli alle pagine 8 - 9
Bluetooth versions for "smart application"; see details to pages 8 - 9

Bike Pendant



220-240 V

SMD Led



Bike è realizzata in alluminio verniciato bianco opaco ed è completa di schermo inferiore in PMMA; si installa sospensione mediante tre cavi in acciaio rivestiti con guaina trasparente e regolabili in altezza grazie ai tre "grip locks" posizionati sul corpo dell'apparecchio. Bike permette di realizzare effetti di luce morbida e diffusa verso il basso ed è particolarmente indicata per l'illuminazione generale di ambienti di medie o grandi dimensioni. La sorgente SMD LED ad alta efficienza è alimentata dal driver integrato nell'apparecchio che può essere On/Off o dimmerabile multifunzione con controllo 1...10V, Push, DALI. Bike è disponibile in diverse misure e potenze e si abbina alle corrispondenti versioni per il montaggio a plafone. Disponibile nelle versioni dimmerabili "signal wireless" Bluetooth per reti mesh Pan Digital o Casambi.

Bike is made of matt white painted aluminium and is complete with lower PMMA screen; the pendant version is installed by means of three steel cables covered with transparent sheath and adjustable in height thanks to the three "grip locks" positioned on the body of the appliance. Bike allows you to create soft and diffused down light effects and is particularly suitable for general lighting of medium or large indoor ambients. The high efficiency SMD LED source is powered by the driver integrated in the fixture which can be On/Off or dimmable multifunction 1... 10V, Push, DALI controlled. Bike is available in different sizes and powers and can be combined with the corresponding versions for ceiling mounting. Available in dimmable "wireless signal" Bluetooth versions for Pan Digital or Casambi mesh network.

Dimensioni / Dimensions

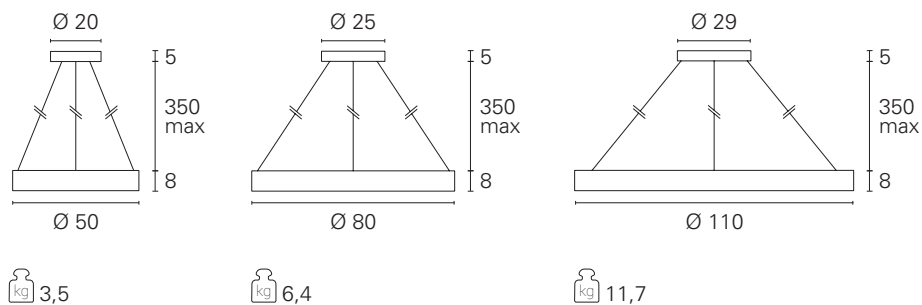

Ottiche / Optics

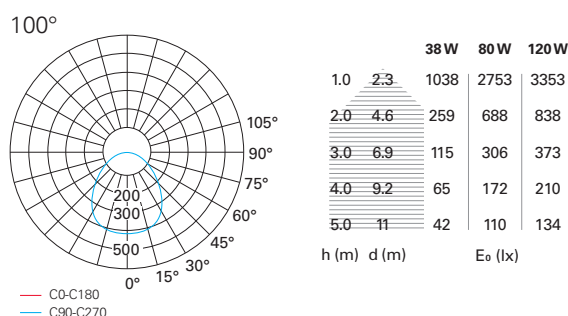

Bike Ceiling
pag. 384



Bike Pendant

modello model	versione version	codice code	colore finishing	Potenza / Flusso Effettivo Power / Lumen Output	CCT CCT	Alimentazione Power feed	IP IP
On / Off	Pendant - Ø 50	GRF09111	Bianco / White	38 W / 2280 lm	3000 K	220÷240 V - class I	IP20
	Pendant - Ø 80	GRF09211	Bianco / White	80 W / 4800 lm	3000 K	220÷240 V - class I	IP20
	Pendant - Ø 110	GRF09311	Bianco / White	120 W / 7200 lm	3000 K	220÷240 V - class I	IP20
Dimmerabile DALI / 1...10V / Push	Pendant - Ø 50	GRF09111DM	Bianco / White	38 W / 2280 lm	3000 K	220÷240 V - class I	IP20
	Pendant - Ø 80	GRF09211DM	Bianco / White	80 W / 4800 lm	3000 K	220÷240 V - class I	IP20
	Pendant - Ø 110	GRF09311DM	Bianco / White	120 W / 7200 lm	3000 K	220÷240 V - class I	IP20

Versioni dimmerabili: regolazione della luminosità 0/1 - 100 % - Dimmable versions: light regulation 0/1 - 100 %

Versioni dimmerabili / Dimmable versions

con controllo della luce wireless Bluetooth
wireless Bluetooth lighting control

versioni version	suffisso codice code suffix	nota note	esempio example
PAN Digital	PD	per ordinare la versione per smart application PAN Digital aggiungere PD alla fine del codice to order the version for smart application PAN Digital add PD to the end of the code	GRF-----PD
CASAMBI	CA	per ordinare la versione per smart application CASAMBI aggiungere CA alla fine del codice to order the version for smart application CASAMBI add CA to the end of the code	GRF-----CA

versioni Bluetooth per "smart application"; vedi dettagli alle pagine 8 - 9
Bluetooth versions for "smart application"; see details to pages 8 - 9

Penny Pendant





Penny Pendant



⊕ 220÷240 V SMD Led  

Penny è realizzata in alluminio verniciato bianco opaco e si caratterizza per il suo grande schermo inferiore in PMMA che si illumina in modo perfettamente uniforme; Penny si installa a sospensione grazie quattro cavi in acciaio rivestito in PVC regolabili in altezza mediante quattro "grip locks" montati sul rosone. Utilizzando Penny si ottengono effetti di luce morbida e diffusa verso il basso con emissioni oltre 12000 lumen nella versione di maggior diametro; Penny è quindi particolarmente indicata per illuminare grandi ambienti con luce uniforme, perfettamente distribuita e senza ombre dure. Equipaggiata con sorgenti SMD LED ad alta efficienza, Penny è completa di driver integrati nel corpo dell'apparecchio ed è disponibile con controllo On/Off o dimmerabile multifunzione 1...10V, Push, DALI. Penny è disponibile in diverse misure e potenze e si abbina alle corrispondenti versioni per l'installazione a soffitto. Disponibile nelle versioni dimmerabili "signal wireless" Bluetooth per reti mesh Pan Digital o Casambi.

Penny is made of matt white painted aluminium and is characterized by its large PMMA lower screen which lights up perfectly evenly; Penny is suspended by means of four PVC-coated steel cables adjustable in height by means of four "grip locks" mounted on the canopy. By using Penny, soft and diffused downward light effects are obtained with emissions beyond 12000 lumens in the larger diameter version; Penny is therefore particularly suitable for illuminating large rooms with uniform light, perfectly distributed and without harsh shadows. Equipped with high efficiency SMD LED sources, Penny is complete with drivers integrated in the body of the fixture and is available with On/Off control or dimmable multifunction 1...10 V, Push, DALI. Penny is available in different sizes and powers and is combined with the corresponding versions for ceiling mounting. Available in dimmable "wireless signal" Bluetooth versions for Pan Digital or Casambi mesh network.

Dimensioni / Dimensions

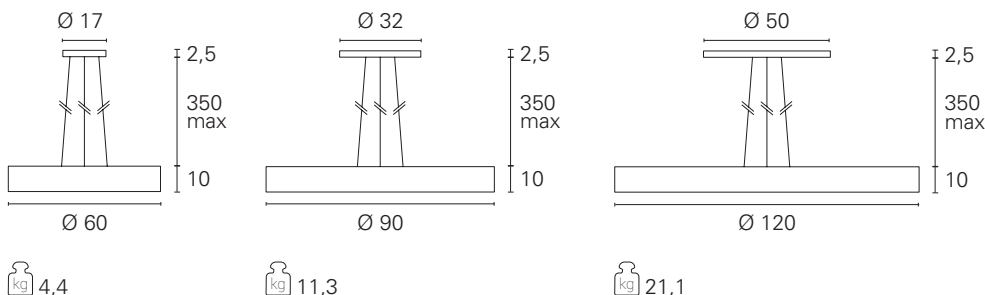

Ottiche / Optics

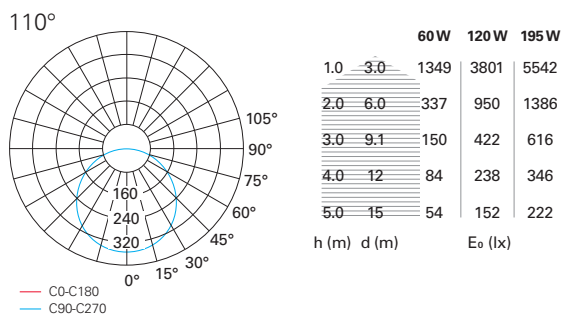

Penny Ceiling
pag. 386



Penny Pendant

modello model	versione version	codice code	colore finishing	Potenza / Flusso Effettivo Power / Lumen Output	CCT CCT	Alimentazione Power feed	IP IP
On / Off	Pendant - Ø 60	GRF10111	Bianco / White	60 W / 3900 lm	3000 K	220÷240 V - class I	IP20
	Pendant - Ø 90	GRF10211	Bianco / White	120 W / 7800 lm	3000 K	220÷240 V - class I	IP20
	Pendant - Ø 120	GRF10311	Bianco / White	195 W / 12675 lm	3000 K	220÷240 V - class I	IP20
Dimmerabile DALI / 1...10V / Push	Pendant - Ø 60	GRF10111DM	Bianco / White	60 W / 3900 lm	3000 K	220÷240 V - class I	IP20
	Pendant - Ø 90	GRF10211DM	Bianco / White	120 W / 7800 lm	3000 K	220÷240 V - class I	IP20
	Pendant - Ø 120	GRF10311DM	Bianco / White	195 W / 12675 lm	3000 K	220÷240 V - class I	IP20

Versioni dimmerabili: regolazione della luminosità 0/1 - 100 % - Dimmable versions: light regulation 0/1 - 100 %

Versioni dimmerabili / Dimmable versions

con controllo della luce wireless Bluetooth
wireless Bluetooth lighting control

versioni version	suffisso codice code suffix	nota note	esempio example
PAN Digital	PD	per ordinare la versione per smart application PAN Digital aggiungere PD alla fine del codice to order the version for smart application PAN Digital add PD to the end of the code	GRF-----PD
CASAMBI	CA	per ordinare la versione per smart application CASAMBI aggiungere CA alla fine del codice to order the version for smart application CASAMBI add CA to the end of the code	GRF-----CA

versioni Bluetooth per "smart application"; vedi dettagli alle pagine 8 - 9
Bluetooth versions for "smart application"; see details to pages 8 - 9

Paralumi in Tessuto







Fabric lights



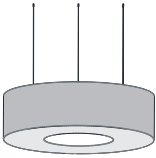
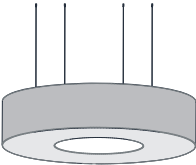
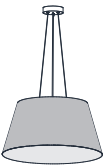

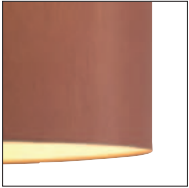
Paralumi in Tessuto

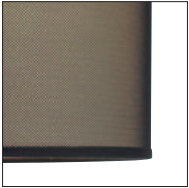
Fabric lights

		6x E27	8x E27	1x E27
		 <p>ø 75 - h. 22</p>	 <p>ø 110 - h. 22</p>	 <p>ø 50/35 - h. 26</p>
<p>LINO LINEN</p> 		<p>SATURNO Pendant p.418</p>	<p>SATURNO Pendant p.418</p>	<p>ARCHER Pendant p.426</p> <p>INGE Floor p.512</p> <p>ETNA p.424</p>
<p>BORDEAUX BORDEAUX</p> 		<p>SATURNO Pendant p.418</p>	<p>SATURNO Pendant p.418</p>	
<p>GRIGIO ARANCIO GREY ORANGE</p> 				
<p>RETINATO NERO BLACK NET</p> 		<p>SATURNO Pendant p.418</p>	<p>SATURNO Pendant p.418</p>	<p>ARCHER Pendant p.426</p> <p>INGE Floor p.512</p> <p>ETNA p.424</p>
<p>PELLE LEATHER</p> 				

1x E27

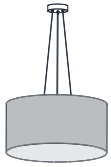

ø 46 - h. 30

1x E27

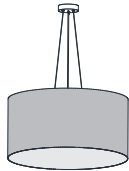

ø 60 - h. 30

3x E27

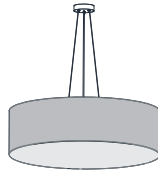

ø 75 - h. 25

Led Panel

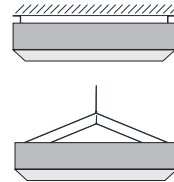

65x65 - h. 15

Led Panel

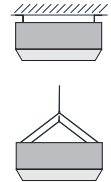

35x35 - h. 15

GIOVE
Pendant p.416
MAIKO
Floor p.520
SHADE
Floor p.518
ZARIA
Floor p.522

ARCHER
Pendant p.426
GIOVE
Pendant p.416

GIOVE
Pendant p.416

URANO
Ceiling p.422
URANO
Pendant p.422

URANO
Ceiling p.422
URANO
Pendant p.422

GIOVE
Pendant p.416
MAIKO
Floor p.520
SHADE
Floor p.518
ZARIA
Floor p.522

GIOVE
Pendant p.416

GIOVE
Pendant p.416

URANO
Ceiling p.422
URANO
Pendant p.422

URANO
Ceiling p.422
URANO
Pendant p.422

MAIKO
Floor p.520
SHADE
Floor p.518
ZARIA
Floor p.522

GIOVE
Pendant p.416
MAIKO
Floor p.520
SHADE
Floor p.518
ZARIA
Floor p.522

ARCHER
Pendant p.426
GIOVE
Pendant p.416

GIOVE
Pendant p.416

URANO
Ceiling p.422
URANO
Pendant p.422

URANO
Ceiling p.422
URANO
Pendant p.422

MAIKO
Floor p.520
SHADE
Floor p.518
ZARIA
Floor p.522

Giove





Giove



⊕ 220÷240 V E27

Giove è un apparecchio a sospensione caratterizzato dal paralume in tessuto montato su telaio. È completo di schermo in pergamena traslucida ed è equipaggiato con attacchi E27. Permette di ottenere effetti di luce diffusa ed è disponibile in diversi diametri. Si sospende fino a 350 cm. grazie a tre cavi in acciaio rivestiti con guaina trasparente, regolabili in altezza con sistema autobloccante "grip lock". Cavo di alimentazione in FEP+PVC trasparente.

Giove is a pendant luminaire characterized by a fabric shade mounted on a frame. It is complete with a translucent parchment screen and is equipped with E27 sockets. It allows to obtain diffused light effects and is available in different diameters. It suspends up to 350 cm. thanks to three steel cables covered with transparent sheath, adjustable in height with self-locking "grip lock" system. Power cable in FEP + transparent PVC.

Colore / Finishing



Lino
Linen

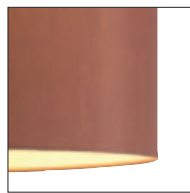

Bordeaux
Bordeaux

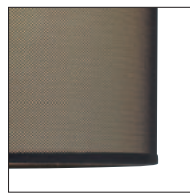

Retinato nero
Black net

Dimensioni / Dimensions

Pendant Ø 46 cm.

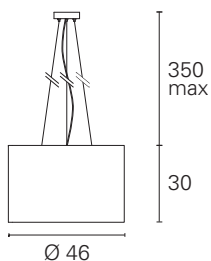
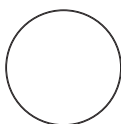

0,7

Pendant Ø 60 cm.

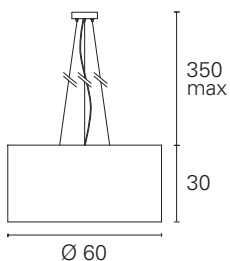
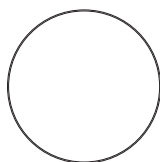

1,2

Pendant Ø 75 cm.

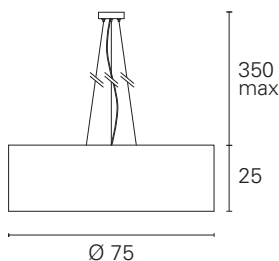
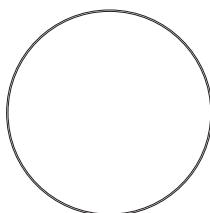

1,8

Giove

Versione Model	Codice Code	Colore Finishing	Potenza / Flusso Effettivo Power / Lumen Output	Sorgente Source	Alimentazione Power feeding	Classe energetica Energy Label	IP IP
Pendant - Ø 46	GRF14101	Lino / Linen	max 40 W (not included)	LED / IAA E27	220÷240 V - class I	A++...D	IP20
Pendant - Ø 46	GRF14102	Bordeaux / Bordeaux	max 40 W (not included)	LED / IAA E27	220÷240 V - class I	A++...D	IP20
Pendant - Ø 46	GRF14103	Retinato Nero / Black Net	max 40 W (not included)	LED / IAA E27	220÷240 V - class I	A++...D	IP20
Pendant - Ø 60	GRF14201	Lino / Linen	max 40 W (not included)	LED / IAA E27	220÷240 V - class I	A++...D	IP20
Pendant - Ø 60	GRF14202	Bordeaux / Bordeaux	max 40 W (not included)	LED / IAA E27	220÷240 V - class I	A++...D	IP20
Pendant - Ø 60	GRF14203	Retinato Nero / Black Net	max 40 W (not included)	LED / IAA E27	220÷240 V - class I	A++...D	IP20
Pendant - Ø 75	GRF14301	Lino / Linen	3x max 40 W (not included)	LED / IAA E27	220÷240 V - class I	A++...D	IP20
Pendant - Ø 75	GRF14302	Bordeaux / Bordeaux	3x max 40 W (not included)	LED / IAA E27	220÷240 V - class I	A++...D	IP20
Pendant - Ø 75	GRF14303	Retinato Nero / Black Net	3x max 40 W (not included)	LED / IAA E27	220÷240 V - class I	A++...D	IP20

Saturno



⊕ 220÷240 V E27

Saturno è un apparecchio a sospensione caratterizzato dal paralume in tessuto montato su telaio e dalla sua geometria ad anello. È completo di schermo in pergamena traslucida ed è equipaggiato con attacchi E27. Permette di ottenere effetti di luce diffusa ed è disponibile in diversi diametri. Urano si installa a sospensione grazie ai cavetti in acciaio rivestito con guaina trasparente; l'altezza di sospensione è regolabile con sistema autobloccante "grip lock" fino ad una altezza di massimo di 350 cm. Cavo di alimentazione in FEP+PVC trasparente.

Saturno is a pendant luminaire characterized by a fabric shade mounted on a frame and by its ring shape. It is complete with a translucent parchment screen and is equipped with E27 sockets. It allows to obtain diffused light effects and is available in different diameters. Saturno can be installed as pendant up to 350 cm cables longer, thanks to four steel cables covered with transparent sheath, adjustable in height with self-locking "grip lock" system. Power cable in FEP+PVC transparent.

Dimensioni / Dimensions

Pendant Ø 75 cm.

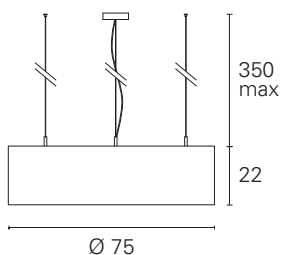
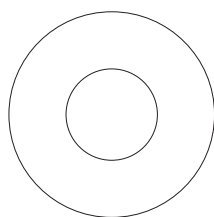

kg 3,0

Pendant Ø 110 cm.

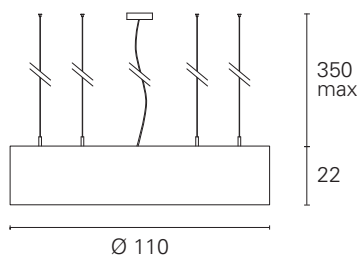
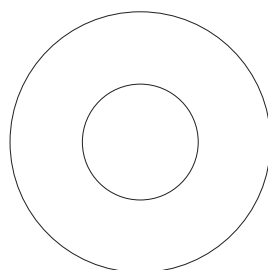

kg 4,5

Colore / Finishing



Lino
Linen



Bordeaux
Bordeaux



Retinato nero
Black net

Saturno

Versione Model	Codice Code	Colore Finishing	Potenza / Flusso Effettivo Power / Lumen Output	Sorgente Source	Alimentazione Power feeding	Classe energetica Energy Label	IP IP
Pendant - Ø 75	GRF13101	Lino / Linen	6x max 40 W (not included)	LED / IAA E27	220÷240 V - class I	A++...D	IP20
Pendant - Ø 75	GRF13102	Bordeaux / Bordeaux	6x max 40 W (not included)	LED / IAA E27	220÷240 V - class I	A++...D	IP20
Pendant - Ø 75	GRF13103	Retinato Nero / Black Net	6x max 40 W (not included)	LED / IAA E27	220÷240 V - class I	A++...D	IP20
Pendant - Ø 110	GRF13201	Lino / Linen	8x max 40 W (not included)	LED / IAA E27	220÷240 V - class I	A++...D	IP20
Pendant - Ø 110	GRF13202	Bordeaux / Bordeaux	8x max 40 W (not included)	LED / IAA E27	220÷240 V - class I	A++...D	IP20
Pendant - Ø 110	GRF13203	Retinato Nero / Black Net	8x max 40 W (not included)	LED / IAA E27	220÷240 V - class I	A++...D	IP20

Urano



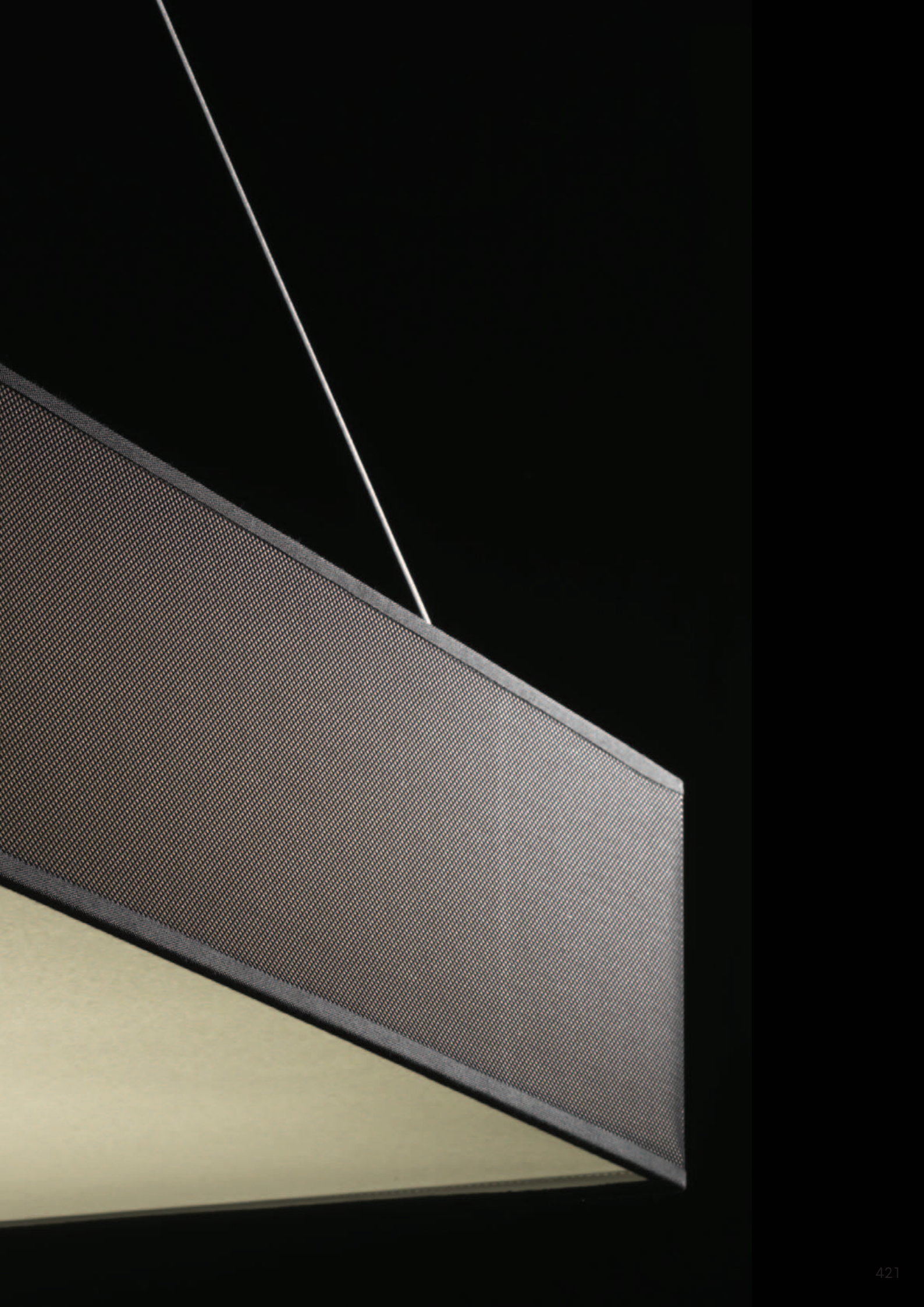

Urano



□ 220÷240 V SMD Led

Urano si installa a plafone o a sospensione; è composto da un pannello a led e da paralume in tessuto completo di schermo in pergamena traslucida. Permette di ottenere effetti di luce estremamente confortevoli grazie all'abbinamento del pannello di tipo "edge led" con la pergamena diffondente. Disponibile in diverse misure e potenze, si installa a sospensione grazie ai cavetti in acciaio rivestito con guaina trasparente; l'altezza di sospensione è regolabile con sistema autobloccante "grip lock" fino ad una altezza di massimo di 350 cm.; la versione a plafone è completa di staffe di fissaggio a soffitto. Cavo di alimentazione in FEP+PVC trasparente.

Urano is a ceiling mounting or pendant luminaire; it is composed of a LED panel and a fabric shade complete with a translucent parchment screen. It allows to obtain extremely comfortable lighting effects thanks to the combination of the "edge led" type panel with the diffusing parchment. Urano can be installed as pendant up to 350 cm cables longer, thanks to four steel cables covered with transparent sheath, adjustable in height with self-locking "grip lock" system; the ceiling mounted version is complete with ceiling fixing brackets. Power cable in FEP + PVC transparent.

Colore / Finishing



Lino
Linen

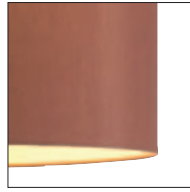

Bordeaux
Bordeaux

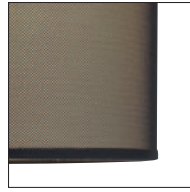

Retinato nero
Black net



Dimensioni / Dimensions

Ceiling

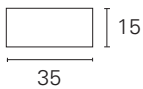

2,8

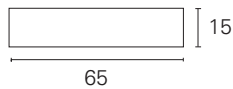

3,8

Pendant

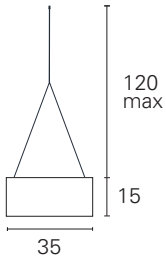

2,8

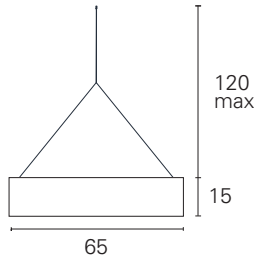

3,8



Urano

Versione Model	Codice Code	Colore Finishing	Potenza / Flusso Effettivo Power / Lumen Output	CCT CCT	Sorgente Source	Alimentazione Power feeding	Classe energetica Energy Label	IP IP
Ceiling mounting - 35 x 35 cm	GRF15101	Lino / Linen	18 W / 1400 lm	3000 K	LED Panel	220÷240 V - class II	LED	IP20
Ceiling mounting - 35 x 35 cm	GRF15102	Bordeaux / Bordeaux	18 W / 1200 lm	3000 K	LED Panel	220÷240 V - class II	LED	IP20
Ceiling mounting - 35 x 35 cm	GRF15103	Retinato Nero / Black Net	18 W / 1100 lm	3000 K	LED Panel	220÷240 V - class II	LED	IP20
Pendant - 35 x 35 cm	GRF15104	Lino / Linen	18 W / 1400 lm	3000 K	LED Panel	220÷240 V - class I	LED	IP20
Pendant - 35 x 35 cm	GRF15105	Bordeaux / Bordeaux	18 W / 1200 lm	3000 K	LED Panel	220÷240 V - class I	LED	IP20
Pendant - 35 x 35 cm	GRF15106	Retinato Nero / Black Net	18 W / 1100 lm	3000 K	LED Panel	220÷240 V - class I	LED	IP20
Ceiling mounting - 65 x 65 cm	GRF15201	Lino / Linen	36 W / 2700 lm	3000 K	LED Panel	220÷240 V - class II	LED	IP20
Ceiling mounting - 65 x 65 cm	GRF15202	Bordeaux / Bordeaux	36 W / 2200 lm	3000 K	LED Panel	220÷240 V - class II	LED	IP20
Ceiling mounting - 65 x 65 cm	GRF15203	Retinato Nero / Black Net	36 W / 1950 lm	3000 K	LED Panel	220÷240 V - class II	LED	IP20
Pendant - 65 x 65 cm	GRF15204	Lino / Linen	36 W / 2700 lm	3000 K	LED Panel	220÷240 V - class I	LED	IP20
Pendant - 65 x 65 cm	GRF15205	Bordeaux / Bordeaux	36 W / 2200 lm	3000 K	LED Panel	220÷240 V - class I	LED	IP20
Pendant - 65 x 65 cm	GRF15206	Retinato Nero / Black Net	36 W / 1950 lm	3000 K	LED Panel	220÷240 V - class I	LED	IP20

Etna



⊕ 220÷240 V E27

Apparecchio a sospensione. Corpo in tessuto montato su telaio. Per lampade con attacco E27 o equivalenti a LED. Illuminazione diretta per effetti di luce concentrata. Cavi di sospensione in acciaio regolabili in altezza con sistema autobloccante "grip lock". lunghezza massima 350 cm. Cavo di alimentazione in FEP+PVC trasparente.

Pendant luminaire. Fabric shade. For E27 light bulb or LED equivalent. Direct light emission for focused light effect. Steel suspension cables adjustable in height with "grip lock" control. maximum length 350 cm. FEP+PVC transparent power cord.



Dimensioni / Dimensions

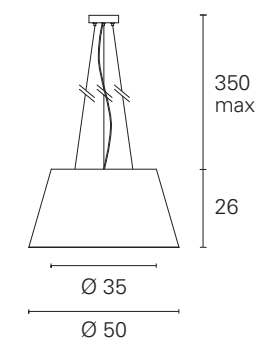

kg 0,8

Colore / Finishing

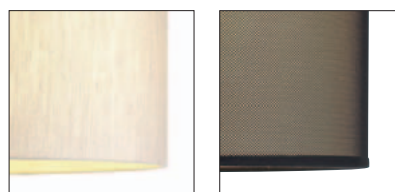

Lino
Linen

Retinato nero
Black net

Etna

Versione Model	Codice Code	Colore Finishing	Potenza / Flusso Effettivo Power / Lumen Output	Sorgente Source	Alimentazione Power feeding	Classe energetica Energy Label	IP IP
Pendant - Ø 50 / 35 cm.	SOS01011	Lino / Linen	max 40 W (not included)	LED / IAA E27	220÷240 V - class I	A++...D	IP20
Pendant - Ø 50 / 35 cm.	SOS01012	Retinato Nero / Black Net	max 40 W (not included)	LED / IAA E27	220÷240 V - class I	A++...D	IP20

Archer

□ 220÷240 V E27

Archer si installa a plafone grazie alla sua basetta di fissaggio che ne permette la rotazione sul piano orizzontale per 330°. Il paralume in tessuto è fissato ad uno stelo ad arco realizzato in acciaio e verniciato bianco opaco o nero opaco. Per lampade con attacco E27 o equivalenti a LED è l'apparecchio ideale per illuminare con luce diffusa zone definite in ambienti indoor.

Archer can be installed on the ceiling thanks to its revolving canopy that allows the horizontal rotation of the lampshade for 330°. The fabric lampshade is fixed to an arched stem made of steel and painted matt white or matt black. For lamps or led bulbs with E27 socket, it is the ideal fixture for illuminating defined areas in indoor environments with diffused light.



Colore / Finishing



Lino
Linen



Retinato nero
Black net



Dimensioni / Dimensions

Ceiling Ø 50/35 cm.

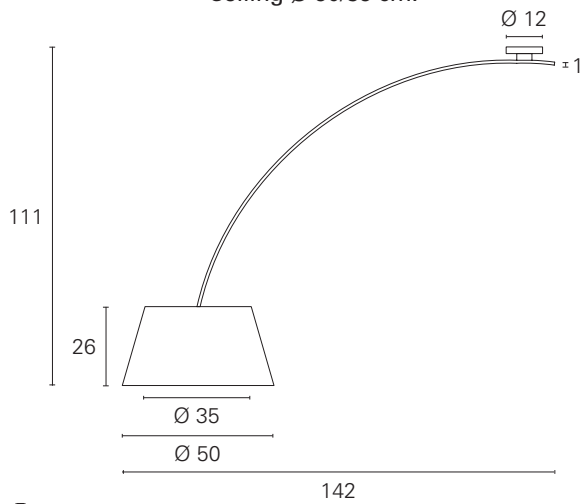

kg 2,3

Ceiling Ø 60 cm.

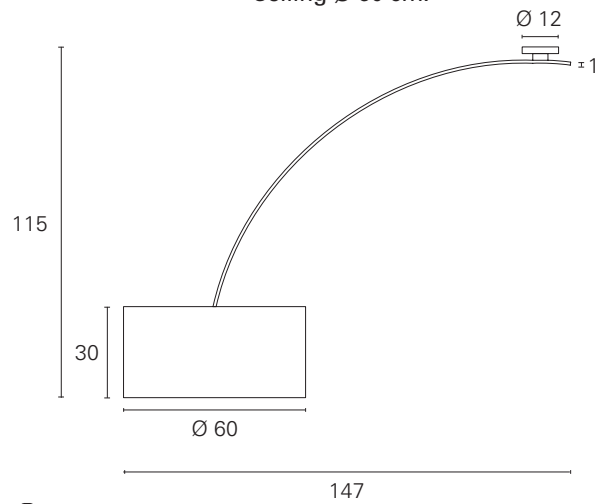

kg 2,5

Archer

Versione Model	Codice Code	Colore Finishing	Potenza / Flusso Effettivo Power / Lumen Output	Sorgente Source	Alimentazione Power feeding	Classe energetica Energy Label	IP IP
Ceiling Arm - Ø 50 / 35	SOS01110	Bianco - Lino / White - Linen	max. 40 W (not incl.)	LED / FBT E27	220÷240 V - class II	A++...D	IP20
Ceiling Arm - Ø 50 / 35	SOS01120	Nero - Retinato Nero / Black - Black Net	max. 40 W (not incl.)	LED / FBT E27	220÷240 V - class II	A++...D	IP20
Ceiling Arm - Ø 60	SOS01111	Bianco - Lino / White - Linen	max 40 W (not incl.)	LED / FBT E27	220÷240 V - class II	A++...D	IP20
Ceiling Arm - Ø 60	SOS01121	Nero - Retinato Nero / Black - Black Net	max 40 W (not incl.)	LED / FBT E27	220÷240 V - class II	A++...D	IP20

Stek





□ 220÷240 V Power Led

Stek è un apparecchio a sospensione disponibile in due diverse misure: il corpo, in alluminio verniciato bianco opaco o nero opaco, può essere lungo 60 o 80 cm. Lo schermo diffondente e il cut-off nero permettono una perfetta schermatura della sorgente led integrata, evitando l'abbagliamento diretto da tutte le direzioni di osservazione. Stek è l'apparecchio ideale per effetti di luce spot estremamente definiti. Equipaggiato con driver elettronico integrato nell'apparecchio, è completo di cavo di sospensione in PVC trasparente, lunghezza massima 350 cm.

Stek is a pendant luminaire available in two different sizes: the body, in matt white or matt black painted aluminium, can be 60 or 80 cm long. The diffusing screen and the black cut-off allow perfect shielding of the integrated LED source, avoiding direct glare from all directions of observation. Stek is the ideal fixture for extremely defined spotlight effects. Equipped with an electronic driver integrated in the luminaire, it is complete with a transparent PVC suspension cable, maximum length 350 cm.

Dimensioni / Dimensions

Pendant h. 60 cm.

Pendant h. 80 cm.

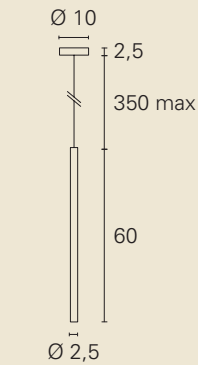

kg 0,6

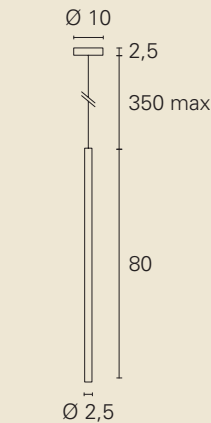

kg 0,7

Ottiche / Optics

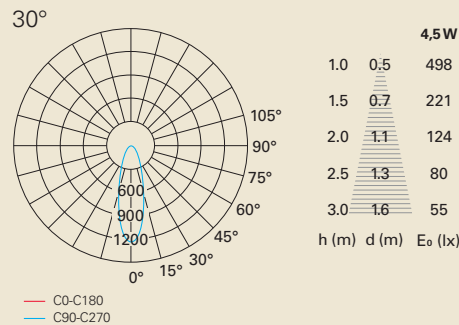

Paco Wall and Ceiling
pag. 487



Stek

Versione Model	Codice Code	Colore Finishing	Potenza / Flusso Effettivo Power / Lumen Output	CCT CCT	Sorgente Source	Alimentazione Power feeding	Classe energetica Energy Label	IP IP
Pendant - h. 60 cm.	SOS11111	Bianco / White	4,5 W / 410 lm	3000 K	Power LED	220÷240 V - class II	LED	IP20
Pendant - h. 60 cm.	SOS11131	Nero / Black	4,5 W / 410 lm	3000 K	Power LED	220÷240 V - class II	LED	IP20
Pendant - h. 80 cm.	SOS11211	Bianco / White	4,5 W / 410 lm	3000 K	Power LED	220÷240 V - class II	LED	IP20
Pendant - h. 80 cm.	SOS11231	Nero / Black	4,5 W / 410 lm	3000 K	Power LED	220÷240 V - class II	LED	IP20

Lupin Pendant





⊕ 220÷240 V GU10

La serie di apparecchi Lupin è realizzata in alluminio verniciato bianco opaco. I corpi ottici sono completi di frontale antiabbagliamento e sono equipaggiati con driver elettronico integrato e attacco lampada GU10. Lupin è progettato per illuminare con effetti di luce concentrata e si completa con le versioni in coordinato per l'installazione a parete. Cavo di sospensione in FEP+PVC trasparente, lunghezza massima 185 cm.

The Lupin luminaire series is made in aluminium matt white painted. The optical bodies are complete with anti-glare front end and are equipped with integrated electronic driver and GU10 socket. Lupin is designed to illuminate with focusing light effects and is completed with coordinated versions for wall installation. Suspension cable in FEP + transparent PVC, maximum length 185 cm.

Dimensioni / Dimensions

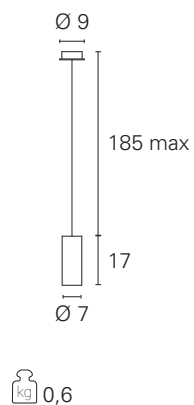

Lupin Wall and Ceiling
pag. 482



Lupin Pendant

Versione Model	Codice Code	Colore Finishing	Potenza / Flusso Effettivo Power / Lumen Output	CCT CCT	Sorgente Source	Alimentazione Power feeding	Classe energetica Energy Label	IP IP
Pendant - h. 17 cm.	SOS063	Bianco / White	7 W / 550 lm	3000 K	LED GU10	220÷240 V - class I	LED	IP20

Descrizione / See details a pag. 292

Cross





Cross



⊕ 220÷240 V SMD Led

La sospensione Cross è realizzata con doppio corpo in alluminio verniciato bianco. Schermo diffondente in PMMA. Sorgente LED ad alta efficienza. Per effetti di luce diffusa. Driver elettronico integrato nell'apparecchio. Anelli luminosi regolabili in modo indipendente in altezza ed inclinazione. Eventuali altre alimentazioni disponibili su richiesta salvo fattibilità. Cavo di sospensione in acciaio rivestito con guaina trasparente; regolabile in altezza con sistema autobloccante "grip lock". lunghezza massima 350 cm.

Cross pendant in made in double white painted aluminium body. PMMA diffusing screen. High efficiency LED light source. For diffused light effects. Electronic driver integrated in the fixture. Height and inclination independently adjustable lighting rings. Other power gears available upon request and after checking feasibility. Steel suspension cables coated with transparent sheath adjustable in height with "grip lock" control. maximum length 350 cm.



Dimensioni / Dimensions

Pendant Ø 40 / 60 cm.

Pendant Ø 60 / 80 cm.

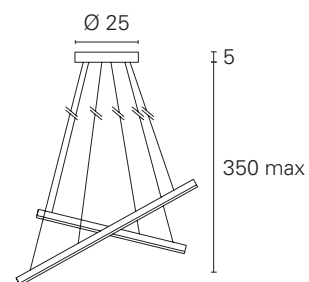
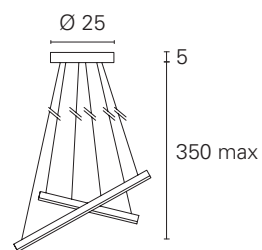
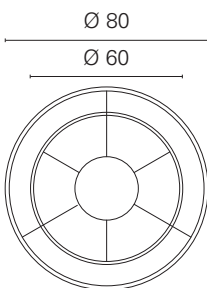
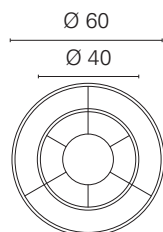

3,5

5,2

Ottiche / Optics

Pendant Ø 40 / 60 cm.

Pendant Ø 60 / 80 cm.

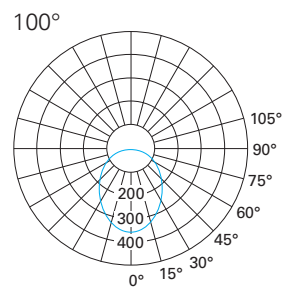
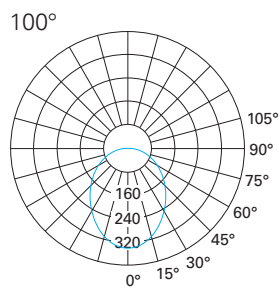

h (m)	d (m)	E ₀ (lx)
0.5	1.2	6742
1.0	2.5	1686
1.5	3.7	749
2.0	4.9	421
2.5	6.2	270

h (m)	d (m)	E ₀ (lx)
0.5	1.1	10867
1.0	2.1	2717
1.5	3.2	1207
2.0	4.2	679
2.5	5.3	435

Cross

Versione Model	Codice Code	Colore Finishing	Potenza / Flusso Effettivo Power / Lumen Output	CCT CCT	Sorgente Source	Alimentazione Power feeding	Classe energetica Energy Label	IP IP
Pendant - Ø 40 / 60	GRF13111	Bianco / White	74 W / 5088 lm	3000 K	SMD LED	220÷240 V - class I	LED	IP20
Pendant - Ø 60 / 80	GRF13211	Bianco / White	104 W / 7630 lm	3000 K	SMD LED	220÷240 V - class I	LED	IP20

Lunar Pendant



⊕ 220÷240 V SMD Led

Apparecchio a sospensione. Corpo in alluminio verniciato bianco opaco. Schermo diffondente in PMMA. Sorgente LED ad alta efficienza. Per effetti di luce diffusa. Driver elettronico integrato nell'apparecchio. Diffusore orientabile. Eventuali altre alimentazioni disponibili su richiesta salvo fattibilità. Cavo di sospensione in PVC di colore bianco. Lunghezza massima 250 cm.

Pendant luminaire. Matt white painted aluminium body. PMMA diffusing screen. High efficiency LED light source. For diffused light effects. Electronic driver integrated in the fixture. Adjustable diffuser. Other power gears available upon request and after checking feasibility. White PVC suspension cable. Maximum length 250 cm.

↑
Flux 10%

Flux 90%
↓

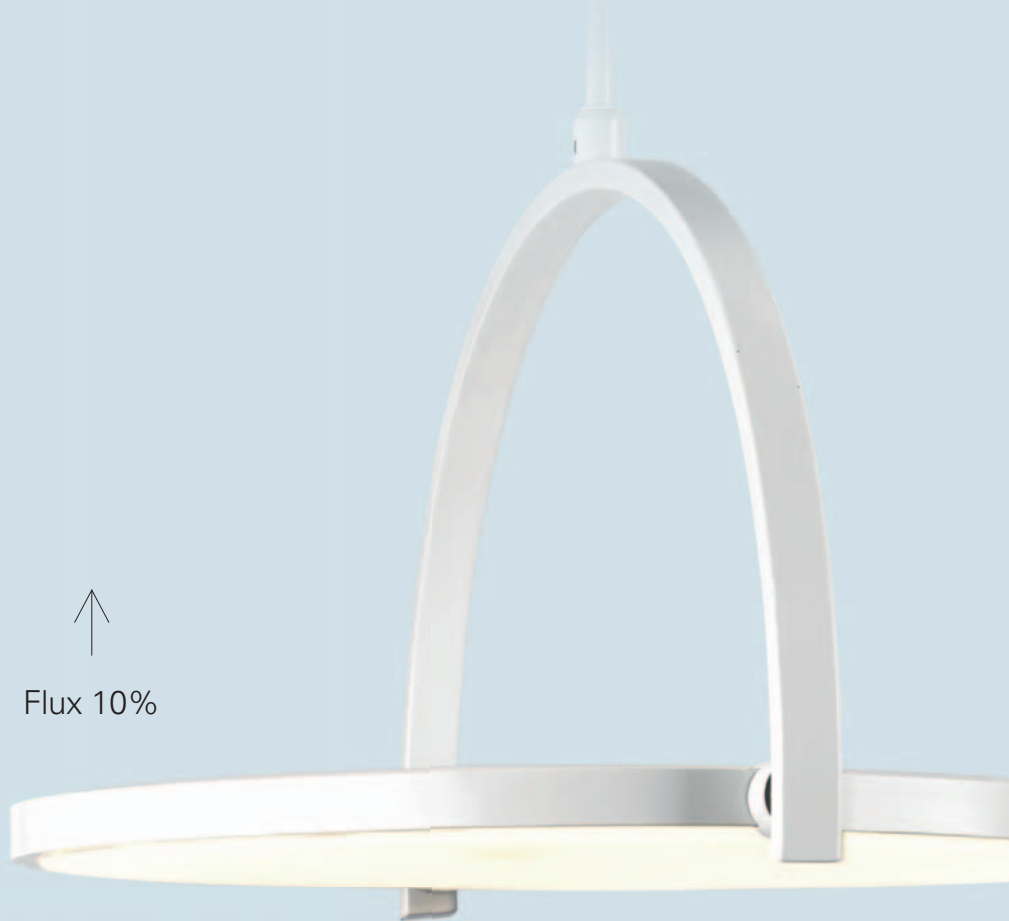

Dimensioni / Dimensions

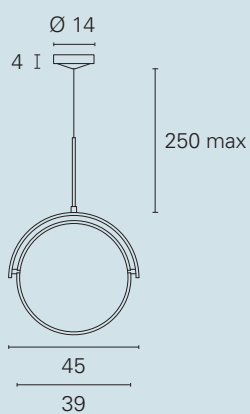

kg 2,7

Ottiche / Optics

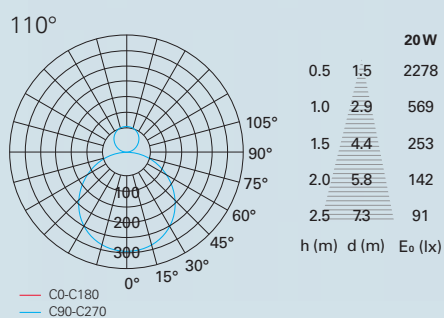

Lunar Floor
pag. 506



Lunar Pendant

Versione Model	Codice Code	Colore Finishing	Potenza / Flusso Effettivo Power / Lumen Output	CCT CCT	Sorgente Source	Alimentazione Power feeding	Classe energetica Energy Label	IP
Pendant - Ø 39 cm.	SOS00056	Bianco / White	20 W / 1910 lm	3000 K	SMD LED	220÷240 V - class I	LED	IP20

Flusso luminoso emesso: semi-diretto; frontale 90% retro 10% / Luminous flux output: semi-direct; front 90% back 10%

Elmet



⊕ 220÷240 V E27

Apparecchio a sospensione. Corpo in alluminio verniciato bianco opaco o nero opaco. Cavo di alimentazione in colore coordinato. Riflettore interno verniciato colore bianco o bronzo. Per lampade con attacco E27 o equivalenti a LED. Illuminazione diretta per effetti di luce concentrata. Cavo di sospensione in PVC di colore bianco, lunghezza massima 250 cm.

Pendant luminaire. Matt white or matt black painted aluminium body. Feeding cable in coordinated color. White or brass painted internal reflector. For E27 light bulb or LED equivalent. Direct light emission for concentrated light effect. White PVC suspension cable, maximum length 250 cm.

Dimensioni / Dimensions

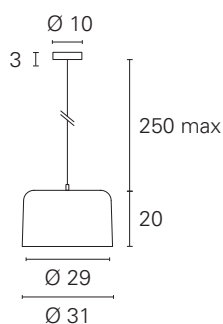

kg 2,1



Elmet

Versione Model	Codice Code	Colore Finishing	Potenza / Flusso Effettivo Power / Lumen Output	Sorgente Source	Alimentazione Power feeding	Classe energetica Energy Label	IP IP
Pendant - Ø 31 cm.	SOS00027	Bianco - Bianco / White - White	max. 40 W (not included)	LED / IAA E27	220÷240 V - class I	A++...D	IP20
Pendant - Ø 31 cm.	SOS00024	Nero - Bronzo / Black - Bronze	max. 40 W (not included)	LED / IAA E27	220÷240 V - class I	A++...D	IP20

Medea



⊕ 220÷240 V E27

Apparecchio a sospensione. Corpo in alluminio verniciato bianco opaco o nero opaco. Per lampade con attacco E27 o equivalenti a LED. Illuminazione diretta per effetti di luce concentrata. Corpo orientabile su staffa. Cavo di sospensione in rivestimento tessile bianco o nero-bianco, lunghezza massima 105 cm.

Pendant luminaire. Matt white or matt black painted aluminium body. For E27 light bulb or LED equivalent. Direct light emission for concentrated light effect. Adjustable body on bracket. White or black-white fabric suspension cable. maximum length 105 cm.



Dimensioni / Dimensions

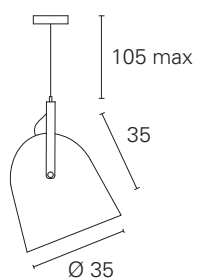

 2,0

Medea

Versione Model	Codice Code	Colore Finishing	Potenza / Flusso Effettivo Power / Lumen Output	Sorgente Source	Alimentazione Power feeding	Classe energetica Energy Label	IP IP
Pendant - Ø 35 cm.	SOS00051	Bianco / White	max. 40 W (not included)	LED / IAA E27	220÷240 V - class I	A++...D	IP20
Pendant - Ø 35 cm.	SOS00050	Nero / Black	max. 40 W (not included)	LED / IAA E27	220÷240 V - class I	A++...D	IP20

Urban Pendant



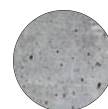

□ 220÷240 V E27

Apparecchio a sospensione. Corpo in cemento liscio. Maniglia in pelle. Per lampade con attacco E27 o equivalenti a LED. Illuminazione diretta per effetti di luce concentrata. Cavo di sospensione in rivestimento tessile di colore nero. lunghezza massima 350 cm.

Pendant luminaire. Polished cement body. Leather handle. For E27 light bulb or LED equivalent. Direct light emission for concentrated light effect. Black fabric suspension cable. maximum length 350 cm.



Dimensioni / Dimensions

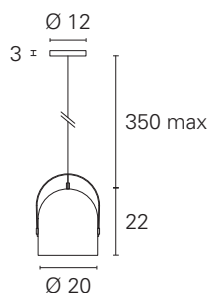

kg 4,0

Urban Table
pag. 534



Urban Pendant

Versione Model	Codice Code	Colore Finishing	Potenza / Flusso Effettivo Power / Lumen Output	CCT CCT	Sorgente Source	Alimentazione Power feeding	Classe energetica Energy Label	IP IP
Pendant - Ø 20 cm.	SOS48000	Grigio / Grey	4 W / 400 lm	2700 K	LED Filament E27	220÷240 V - class II	LED	IP20

Descrizione / See details a pag. 308

Bay



□ 220÷240 V E27

Apparecchio a sospensione. Corpo in alluminio verniciato nero opaco. Per lampade con attacco E27 o equivalenti a LED. Illuminazione diretta per effetti di luce concentrata. Cavo di sospensione in catena di acciaio di colore nero. lunghezza massima 350 cm. Cavo di alimentazione in rivestimento tessile di colore nero, lunghezza massima 350 cm.

Pendant luminaire. Matt black painted aluminium body. For E27 light bulb or LED equivalent. Direct light emission for concentrated light effect. Black steel chain suspension cable. maximum length 350 cm. Black fabric power cord, maximum length 350 cm.



Dimensioni / Dimensions

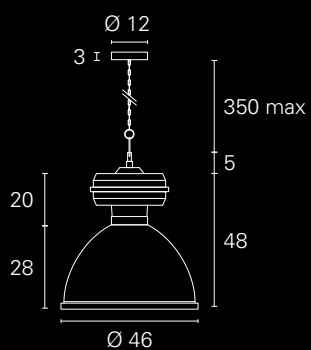

 7,0

Bay

Versione Model	Codice Code	Colore Finishing	Potenza / Flusso Effettivo Power / Lumen Output	CCT CCT	Sorgente Source	Alimentazione Power feeding	Classe energetica Energy Label	IP IP
Pendant - Ø 46cm.	SOS00093	Nero / Black	13 W	2700 K	LED Filament E27	220÷240 V - class II	LED	IP20

Bond



⊕ 220÷240 V SMD Led

Apparecchio a sospensione. Corpo in alluminio verniciato bianco opaco. Schermo diffondente in PMMA. Sorgente SMD LED integrata. Illuminazione diretta per effetti di luce concentrata. Cavo di sospensione in rivestimento tessile di colore bianco, lunghezza massima 250 cm.

Pendant luminaire. Matt white painted aluminium body. PMMA diffusing screen. Integrated light source SMD Led. Direct light emission for concentrated light effect. White fabric suspension cable, maximum length 250 cm.



Dimensioni / Dimensions

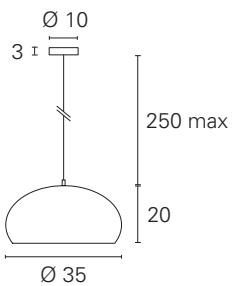

kg 3,2

Ottiche / Optics

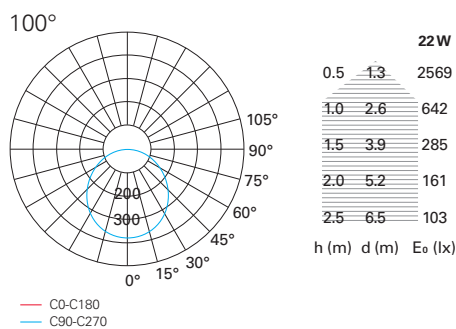

Bond

Versione Model	Codice Code	Colore Finishing	Potenza / Flusso Effettivo Power / Lumen Output	CCT CCT	Sorgente Source	Alimentazione Power feeding	Classe energetica Energy Label	IP IP
Pendant - Ø 35 cm.	SOS00046	Bianco / White	22 W / 1685 lm	3000 K	SMD LED	220÷240 V - class I	LED	IP20

Bugle



⊕ 220÷240 V E27

Apparecchio a sospensione. Corpo in gesso liscio bianco. Per lampade con attacco E27 o equivalenti a LED. Illuminazione diretta per effetti di luce concentrata. Cavo di sospensione in rivestimento tessile di colore bianco, lunghezza massima 250 cm.

Pendant luminaire. White polished plaster body. For E27 light bulb or LED equivalent. Direct light emission for concentrated light effect. White fabric suspension cable. maximum length 250 cm.



Dimensioni / Dimensions

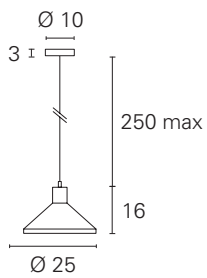

 1,5

Gesso
Plaster



Bugle

Versione Model	Codice Code	Colore Finishing	Potenza / Flusso Effettivo Power / Lumen Output	Sorgente Source	Alimentazione Power feeding	Classe energetica Energy Label	IP IP
Pendant - Ø 25 cm.	SOS10009	Bianco / White	max. 40 W (not included)	LED / IAA E27	220÷240 V - class I	A+...D	IP20

Minimal



□ 220÷240 V E27

Apparecchio a sospensione. Corpo in alluminio verniciato o anodizzato. Per lampade con attacco E27 o equivalenti a LED. Per effetti di luce diffusa. Cavo di sospensione in rivestimento tessile di colore grigio o bianco. lunghezza massima 130 cm.

Pendant luminaire. Painted or anodized aluminium body. For E27 light bulb or LED equivalent. For diffused light effects. Grey or white fabric suspension cable, maximum length 130 cm.



Dimensioni / Dimensions

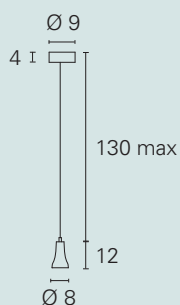

 0,5

Minimal

Versione Model	Codice Code	Colore Finishing	Potenza / Flusso Effettivo Power / Lumen Output	Sorgente Source	Alimentazione Power feeding	Classe energetica Energy Label	IP IP
Pendant - h. 12 cm.	SOS057	Bianco (cavo bianco) / White (white cable)	max. 60 W (not incl.)	LED / IAA E27	220÷240 V - class II	A++...D	IP20
Pendant - h. 12 cm.	SOS058	Acciaio (cavo grigio) / Steel (gray cable)	max. 60 W (not incl.)	LED / IAA E27	220÷240 V - class II	A++...D	IP20

Brio



□ 220÷240 V E27

Apparecchio a sospensione. Corpo in metallo anodizzato. Cavo di alimentazione in tessuto avvolgibile sull'apposita asola del corpo portalampada; sistema di apertura dell'asola a scatto. Per lampade con attacco E27 o equivalenti a LED. Per effetti di luce decorativa e scenografica dell'ambiente. Lampade LED Filament incluse. Cavo di sospensione in rivestimento tessile di colore nero-bianco. lunghezza massima 350 cm.

Pendant luminaire. Anodized metal body. Power cable in roll-up fabric on the specific slot of the body; snap-on opening system of the slot. For E27 light bulb or LED equivalent. For decorative and scenic light effects. Filament LED bulb included. Black-white fabric suspension cable. maximum length 350 cm.



Dimensioni / Dimensions

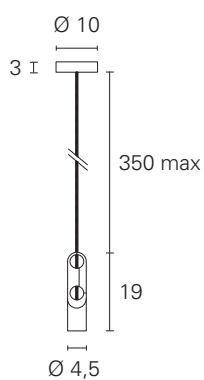

 0,6

Brio

Versione Model	Codice Code	Colore Finishing	Potenza / Flusso Effettivo Power / Lumen Output	CCT CCT	Sorgente Source	Alimentazione Power feeding	Classe energetica Energy Label	IP IP
Pendant - h. 19 cm.	SOS00102	Nero / Black	4 W / 400 lm	2700 K	LED Filament E27	220÷240 V - class II	LED	IP20
Pendant - h. 19 cm.	SOS00103	Bianco / White	4 W / 400 lm	2700 K	LED Filament E27	220÷240 V - class II	LED	IP20
Pendant - h. 19 cm.	SOS00104	Rame / Copper	4 W / 400 lm	2700 K	LED Filament E27	220÷240 V - class II	LED	IP20
Pendant - h. 19 cm.	SOS00105	Acciaio / Steel	4 W / 400 lm	2700 K	LED Filament E27	220÷240 V - class II	LED	IP20

Rod



⊕ 220÷240 V E27

Rod Pendant si installa a sospensione e può essere utilizzata in coordinato con le piantane versioni Rod Floor. Realizzata in metallo verniciato bianco opaco o nero opaco è completa di attacco lampada E27 e di cavo di alimentazione in tinta. È disponibile in due versioni, a sospensione singola e a tripla sospensione; quest'ultima versione è dotata di rosone unico per tutte e tre le sospensioni. Rod Pendant viene fornita con lampada a bulbo LED Filament che la completa caratterizzandone il design.

Rod Pendant is suspended and can be used in coordination with the Rod Floor versions. Made in matt white or matt black painted metal, it is complete with E27 lamp socket and matching power cable. It is available in two versions, with single suspension and triple suspension; the latter version is equipped with a single canopy for all three suspensions.

Rod Pendant is supplied with a Filament LED bulb lamp that completes it and characterizes its design.



Dimensioni / Dimensions

Pendant 1x lamp

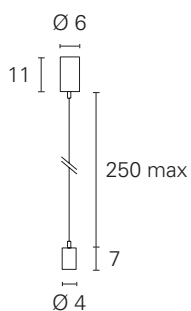

kg 0,3

Pendant 3x lamps

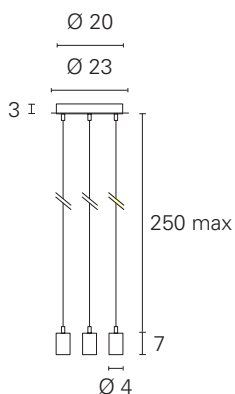

kg 1,4

Rod Floor
pag. 508



Rod

Versione Model	Codice Code	Colore Finishing	Potenza / Flusso Effettivo Power / Lumen Output	CCT CCT	Sorgente Source	Alimentazione Power feeding	Classe energetica Energy Label	IP IP
Pendant - 1x lamp	SOS00049	Nero / Black	6 W / 450 lm	2700 K	LED Filament E27	220÷240 V - class I	LED	IP20
Pendant - 1x lamp	SOS00053	Bianco / White	6 W / 450 lm	2700 K	LED Filament E27	220÷240 V - class I	LED	IP20
Pendant - 3x lamps	SOS10037	Nero / Black	3x 6 W / 450 lm	2700 K	LED Filament E27	220÷240 V - class I	LED	IP20
Pendant - 3x lamps	SOS10040	Bianco / White	3x 6 W / 450 lm	2700 K	LED Filament E27	220÷240 V - class I	LED	IP20

A Parete

Wall Mounted



Match
p.458

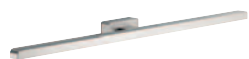

Fair
p.460



Onda
p.462



Elle
p.463



Tablet
p.464

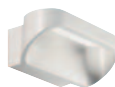

Grace
p.465



Orion
p.466



Spillo
p.467



Pod
p.468



Boreale
p.469

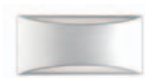

Idra
p.470

Gesso
Plaster 



Tube
p.471



Oberon
p.472



Polaris
p.473



Eli
p.474



Eclis
p.475



Fast
p.476



Polka
p.480



Lupin Wall
p.482



Barro
p.484



Dippy
p.486



Pako
p.487



Professional
p.488



Berlin
p.492



London
p.493



Paris
p.494



Cama
p.495



Soft
p.496



Jazz
p.497



Tina
p.498



Emma
p.499



Susy
p.500



Giuly
p.501

Match



⊕ 220÷240 V SMD Led

Match si installa a parete ed è indicato per effetti di luce lineare. Realizzato in alluminio verniciato bianco opaco, è dotato di schermo in vetro diffondente, di sorgente SMD LED ad alta efficienza e di driver elettronico integrato nell'apparecchio. L'emissione è bidirezionale verso l'alto e verso il basso, per effetti di luce radente sulla parete.

Match is installed on the wall and is suitable for linear lighting effects. Made of opaque white painted aluminium, it is equipped with a diffusing glass screen, a high efficiency SMD LED source and an electronic driver integrated in the luminaire. The emission is bidirectional upwards and downwards, due to grazing light effects on the wall

Dimensioni / Dimensions

Wall l. 58 cm.

Wall l. 88 cm.

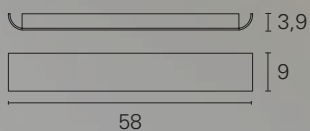

 1,1

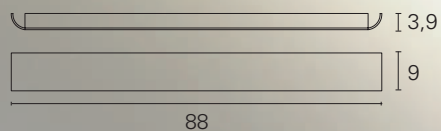

 1,8

Match

Versione Model	Codice Code	Colore Finishing	Potenza / Flusso Effettivo Power / Lumen Output	CCT CCT	Sorgente Source	Alimentazione Power feeding	Classe energetica Energy Label	IP IP
Wall mounting - 58 cm.	PAR04111	Bianco / White	20 W / 1625 lm	3000 K	SMD LED	220÷240 V - class I	LED	IP20
Wall mounting - 88 cm.	PAR04211	Bianco / White	32 W / 2808 lm	3000 K	SMD LED	220÷240 V - class I	LED	IP20

Fair



⊕ 220÷240 V SMD Led AC

Fair si installa a parete grazie alla basetta integrata al corpo; è realizzato in alluminio anodizzato naturale o in alluminio verniciato bianco. Fair è completo di schermo diffondente in PMMA, di sorgente SMD LED ad alta efficienza e di driver integrato; permette di realizzare effetti di luce diffusa sulla parete e ha grado di protezione IP54.

Fair is installed on the wall thanks to the base integrated in the body; it is made of natural anodized aluminium or white painted aluminium. Fair is complete with PMMA diffusing screen, high efficiency SMD LED source and integrated driver; it allows to realize diffused light effects on the wall and has IP54 protection degree.



Dimensioni / Dimensions

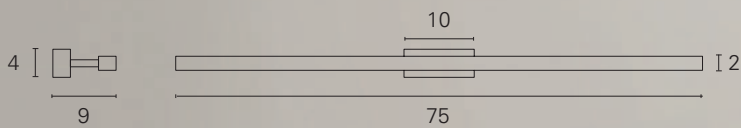

 0,9

Fair

Versione Model	Codice Code	Colore Finishing	Potenza / Flusso Effettivo Power / Lumen Output	CCT CCT	Sorgente Source	Alimentazione Power feeding	Classe energetica Energy Label	IP IP
Wall mounting - 75 cm.	PAR20271	Alluminio / Aluminum	17 W / 1530 lm	3000 K	SMD LED AC	220÷240 V - class I	LED	IP54
Wall mounting - 75 cm.	PAR20211	Bianco / White	17 W / 1530 lm	3000 K	SMD LED AC	220÷240 V - class I	LED	IP54

Onda

⊕ 220÷240 V SMD Led

Onda è realizzato in alluminio verniciato bianco opaco. È dotato di schermo in vetro diffondente ed è equipaggiato con sorgente SMD LED ad alta efficienza e driver integrato. È l'ideale per effetti di luce indiretta ed è in grado di illuminare l'area circostante con luce diffusa. Grazie al grado di protezione IP54 è installabile in ambienti interni ed esterni.

Onda is made of matt white painted aluminium. It has a diffusing glass screen and is equipped with a high efficiency SMD LED source and integrated driver. It is ideal for indirect light effects and is able to illuminate the surrounding area with diffused light. Thanks to the degree of protection IP54, it can be installed in indoor and outdoor.

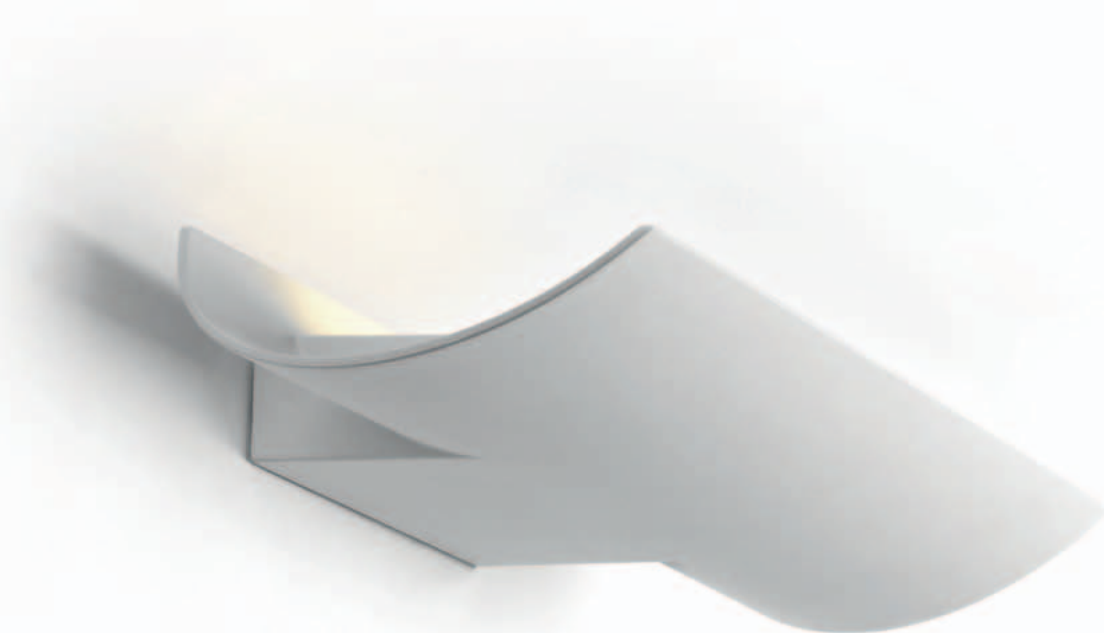

Dimensioni / Dimensions



kg 1,2

Ottiche / Optics

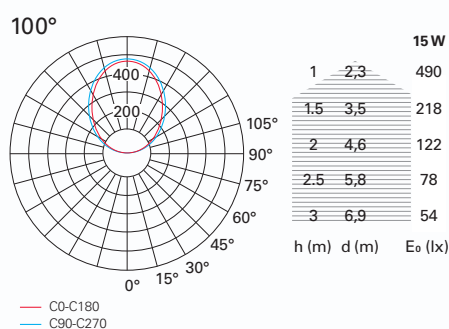

Onda

IP54

Versione Model	Codice Code	Colore Finishing	Potenza / Flusso Effettivo Power / Lumen Output	CCT CCT	Sorgente Source	Alimentazione Power feeding	Classe energetica Energy Label	IP IP
Wall mounting - 30 cm.	PAR00012	Bianco / White	15 W / 1270 lm	3000 K	SMD LED	220÷240 V - class I	LED	IP54

Elle

⊕ 220÷240 V CoB Led

Elle è realizzato in alluminio verniciato bianco opaco ed è dotato di schermo in vetro diffondente. Si installa a parete ed è completo di sorgente LED ad alta efficienza e di driver integrato. È particolarmente indicato per l'illuminazione diffusa dell'ambiente grazie alla sua emissione "uplight".

Elle is made of matt white painted aluminium and is equipped with a diffusing glass screen. It can be installed on the wall and is complete with high efficiency LED source and integrated driver. It is particularly suitable for diffused lighting of the environment thanks to its "uplight" emission.



Dimensioni / Dimensions

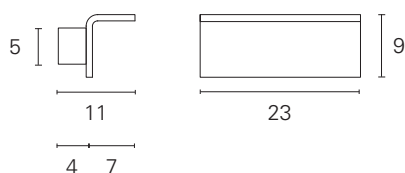

kg 1,0

Ottiche / Optics

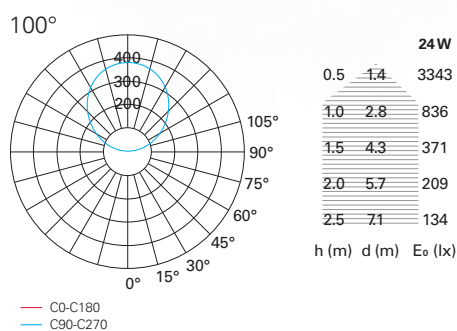

Elle

Versione Model	Codice Code	Colore Finishing	Potenza / Flusso Effettivo Power / Lumen Output	CCT CCT	Sorgente Source	Alimentazione Power feeding	Classe energetica Energy Label	IP IP
Wall mounting - 23 cm.	PAR00016	Bianco / White	24 W / 2230 lm	3000 K	CoB LED	220÷240 V - class I	LED	IP20

Tablet

⊕ 220÷240 V SMD Led

Apparecchio da parete. Corpo in alluminio verniciato bianco opaco. Schermo in vetro diffondente. Sorgente LED ad alta efficienza integrata. Per effetti di luce diffusa. Driver elettronico integrato nell'apparecchio. Installabile sia come downlighter per effetti di luce diretta sia come uplighter per effetti di luce indiretta.

Wall luminaire. Matt white painted aluminium body. Glass diffusing screen. Integrated high efficiency LED light source. For diffused light effects. Electronic driver integrated in the fixture. Product can be installed as a downlighter for direct light effects or as an uplighter for indirect light effects.



Dimensioni / Dimensions

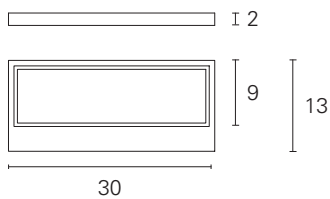

kg 1,1

Ottiche / Optics

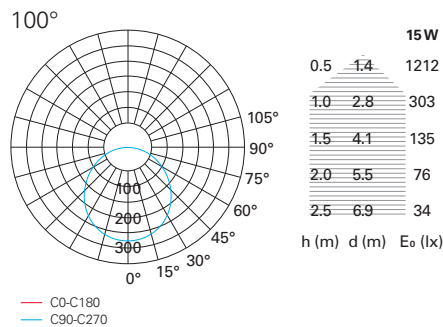

Tablet

Versione Model	Codice Code	Colore Finishing	Potenza / Flusso Effettivo Power / Lumen Output	CCT CCT	Sorgente Source	Alimentazione Power feeding	Classe energetica Energy Label	IP IP
Wall mounting - 30 cm.	PAR00010	Bianco / White	15 W / 1100 lm	3000 K	SMD LED	220÷240 V - class I	LED	IP54

Grace

⊕ 220÷240 V Power Led

Grace, realizzata in alluminio, è particolarmente indicata per l'illuminazione diffusa negli ambienti indoor. È disponibile nelle due versioni da 18 cm e da 30 cm. di larghezza, equipaggiate rispettivamente con power led 5 W per emissione indiretta e 2x 5W per doppia emissione diretta / indiretta. Entrambe le versioni sono disponibili in colore bianco o bicolore, bianco per la parte interna a vista e alluminio per la parte esterna. È completa di driver integrato.

Grace, realized in aluminum, is particularly suitable for diffused lighting in indoor ambients. It is available in two versions of 18 cm and 30 cm. wide, equipped respectively with 5 W power LED for indirect emission and 2x 5W for double direct / indirect emission. Both versions are available in white or two-tone, white for the internal visible part and aluminum for the external part. It comes complete with integrated driver.



Dimensioni / Dimensions

Wall l. 18 cm.

Wall l. 30 cm.

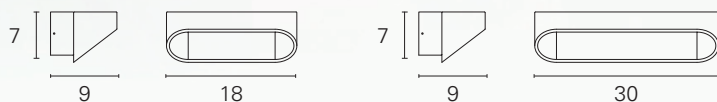

kg 0,6

kg 1,0

Grace

Versione Model	Codice Code	Colore Finishing	Potenza / Flusso Effettivo Power / Lumen Output	CCT CCT	Sorgente Source	Alimentazione Power feeding	Classe energetica Energy Label	IP IP
Wall mounting - 18 cm.	PAR264	Alluminio - Bianco / Aluminum - White	5 W / 310 lm	3000 K	Power LED	220÷240 V - class I	LED	IP20
Wall mounting - 18 cm.	PAR265	Bianco / White	5 W / 310 lm	3000 K	Power LED	220÷240 V - class I	LED	IP20
Wall mounting - 30 cm.	PAR267	Alluminio - Bianco / Aluminum - White	2x 5 W / 630 lm	3000 K	Power LED	220÷240 V - class I	LED	IP20
Wall mounting - 30 cm.	PAR268	Bianco / White	2x 5 W / 630 lm	3000 K	Power LED	220÷240 V - class I	LED	IP20

Orion

⊕ 220÷240 V SMD Led

Orion è costituita da una struttura in metallo verniciato bianco sul quale si monta uno schermo opalino in PMMA, di forma convessa e realizzato in un unico pezzo. Orion è equipaggiata con sorgenti LED SMD e il driver è integrato nel corpo dell'apparecchio; si installa sia a soffitto che a parete ed è indicata per illuminare gli ambienti con luce diffusa.

Orion is realized with a white painted metal structure on which is mounted an opal PMMA screen, convex in shape and made in one piece. Orion is equipped with SMD LED sources and the driver is integrated into the body of the fixtures; it can be installed both on the ceiling and on the wall and is suitable for illuminating rooms with diffused light.



Dimensioni / Dimensions

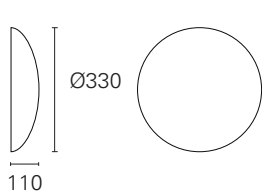

kg 0,60

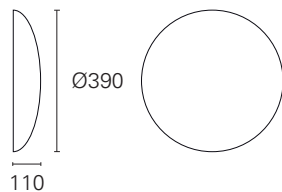

kg 0,80

Ottiche / Optics

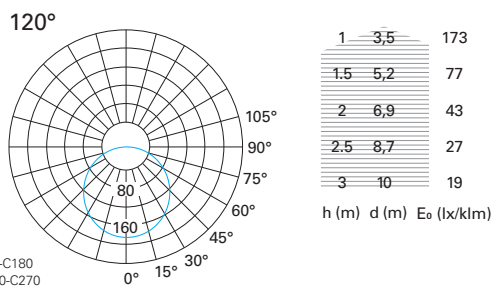

Orion

modello model	versione version	potenza power	codice code	temp. di colore light temperature	CRI CRI	flusso apparecchio light output	Alimentazione Power feeding	ottica optic	colore colour
Rounded	On/Off	18 W	PLA00009	3000 K	> 80	1170 lm	220÷240 V - class I	120°	bianco / white
			PLA00012	4000 K	> 80	1220 lm	220÷240 V - class I	120°	bianco / white
	22 W	PLA00010	3000 K	> 80	1430 lm	220÷240 V - class I	120°	bianco / white	
		PLA00013	4000 K	> 80	1500 lm	220÷240 V - class I	120°	bianco / white	

Spillo

□ 220÷240 V T5 G5

Apparecchio da parete o da soffitto. Corpo in metallo cromato. Schermo trasparente in pyrex. Per lampada fluorescente lineare T5 inclusa. Per effetti di luce diffusa. Driver elettronico integrato nell'apparecchio.

Wall or ceiling luminaire. Chromed metal body. Transparent screen in pyrex. For T5 fluorescent linear bulb included. For diffused light effects. Electronic driver integrated in the fixture.



Dimensioni / Dimensions



 1,6

Spillo

Versione Model	Codice Code	Colore Finishing	Potenza / Flusso Effettivo Power / Lumen Output	CCT CCT	Sorgente Source	Alimentazione Power feeding	Classe energetica Energy Label	IP IP
Wall / Ceiling mounting - 64 cm.	PAR602	Cromo / Chrome	13 W / 950 lm	4000 K	T5 G5	220÷240 V - class II	B	IP44

Pod

⊕ 220÷240 V SMD Led

Pod si installa a parete; è realizzato in gesso liscio bianco che rende l'apparecchio verniciabile esternamente anche dopo l'installazione; dotato di sorgente LED ad alta efficienza integrata e di driver è indicato per l'illuminazione diffusa dell'ambiente con luce indiretta.

Pod is installed on the wall; it is made of smooth white plaster which makes the device paintable externally even after installation; equipped with integrated high efficiency LED source and driver, it is suitable for diffused lighting of the environment with indirect light.

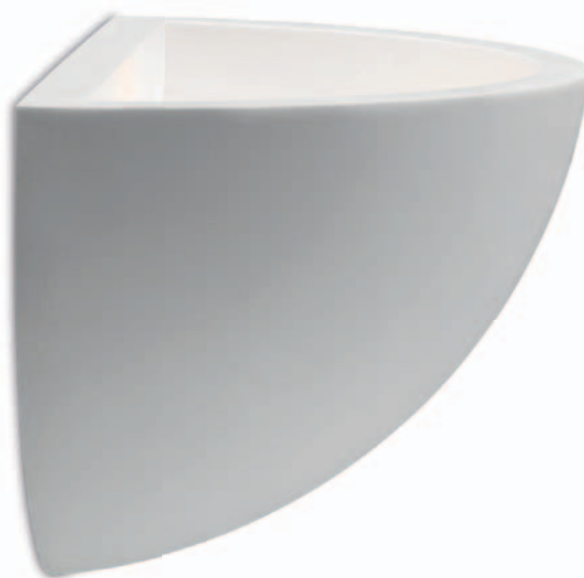

Dimensioni / Dimensions

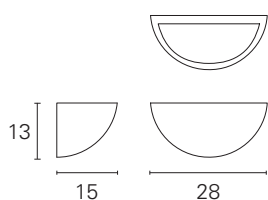

kg 2,0

Gesso
Plaster



Pod

Versione Model	Codice Code	Colore Finishing	Potenza / Flusso Effettivo Power / Lumen Output	CCT CCT	Sorgente Source	Alimentazione Power feeding	Classe energetica Energy Label	IP IP
Wall mounting - 28 cm.	PAR10327	Bianco / White	6,3 W / 520 lm	3000 K	SMD LED	220÷240 V - class I	LED	IP20

Boreale

⊕ 220÷240 V SMD Led / E14

Boreale si installa a parete ed è verniciabile esternamente anche dopo la prima installazione. L'emissione di luce è bidirezionale e consente di ottenere effetti di luce radente sulla parete. Il Corpo è realizzato in gesso liscio bianco ed è completo di schermo in vetro diffondente, di sorgente LED ad alta efficienza e di driver integrato. Completa la gamma la versione per sorgenti luminose con attacco E14.

Boreale can be installed in walls and can be painted externally even after the first installation. The light emission is bidirectional and allows to obtain grazing light effects on the wall. The body is made of smooth white plaster and is complete with diffusing glass screen, high efficiency LED source and integrated driver. The range is completed by the version for light sources with E14 socket.



Dimensioni / Dimensions

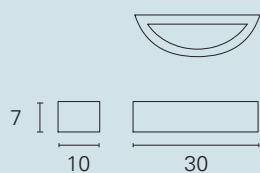

kg 1,3

Gesso
Plaster

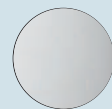

Boreale

Versione Model	Codice Code	Colore Finishing	Potenza / Flusso Effettivo Power / Lumen Output	CCT CCT	Sorgente Source	Alimentazione Power feeding	Classe energetica Energy Label	IP IP
Wall mounting - 30 cm.	PAR310	Bianco / White	max. 15 W (not included)	\	LED / IAA E14	220÷240 V - class I	A++...D	IP20
Wall mounting - 30 cm.	PAR10326	Bianco / White	2x 6 W / 2x 500 lm	3000 K	SMD LED	220÷240 V - class I	LED	IP20

Idra

⊕ 220÷240 V SMD Led

Apparecchio da parete. Il corpo dell'apparecchio è realizzato in gesso liscio bianco, che lo rende verniciabile esternamente anche dopo la prima installazione. Sorgente LED ad alta efficienza integrata. Emissione bidirezionale per effetti di luce radente sulla parete. Driver elettronico integrato nell'apparecchio.

Wall mounted fixture. The body of the appliance is made of smooth white plaster, which makes it paintable externally even after the first installation. Integrated high efficiency LED source. Bidirectional emission for grazing light effects on the wall. Electronic driver integrated.



Dimensioni / Dimensions

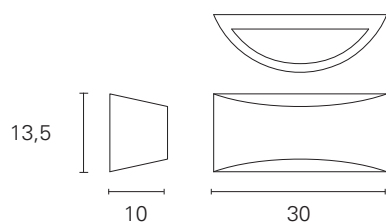

kg 1,5

Gesso
Plaster



Idra

Versione Model	Codice Code	Colore Finishing	Potenza / Flusso Effettivo Power / Lumen Output	CCT CCT	Sorgente Source	Alimentazione Power feeding	Classe energetica Energy Label	IP IP
Wall mounting - 30 cm.	PAR10328	Bianco / White	2x 6 W / 2x 500 lm	3000 K	SMD LED	220÷240 V - class I	LED	IP20

Tube

⊕ 220÷240 V GU10

Apparecchio da parete. Corpo in gesso liscio bianco verniciabile esternamente. Schermo diffondente e frontale antiabbagliamento. Equipaggiato con attacco GU10. Emissione monodirezionale o bidirezionale per effetti di luce radente sulla parete.

Wall mounted fixture. White smooth plaster body externally paintable. Diffusing screen and anti-glare front. Equipped with GU10 socket. One-way or two-way emission for grazing light effects on the wall.



Dimensioni / Dimensions

Downlight

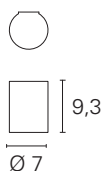

kg 0,4

Uplight / Downlight

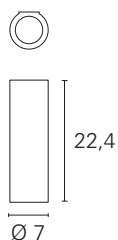

kg 0.8

Gesso
Plaster



Tube

Versione Model	Codice Code	Colore Finishing	Potenza / Flusso Effettivo Power / Lumen Output	Sorgente Source	Alimentazione Power feeding	Classe energetica Energy Label	IP IP
Wall mounting - Downlight	PAR10000	Bianco / White	1x max. 35 W (not included)	LED GU10	220÷240 V - class I	A++...D	IP20
Wall mounting - Uplight / Downlight	PAR10002	Bianco / White	2x max. 35 W (not included)	LED GU10	220÷240 V - class I	A++...D	IP20

Oberon

⚡ 220÷240 V Power Led

Apparecchio da parete.
Corpo in gesso liscio bianco
verniciabile esternamente.
Schermo diffondente
e frontale antiabbagliamento.
Sorgente LED ad alta efficienza integrata.
Emissione bidirezionale per effetti di luce
radante sulla parete. Driver elettronico integrato
nell'apparecchio. Corpo dell'apparecchio
verniciabile.

*Wall luminaire. White polished plaster
body externally paintable.
Front antiglare diffuser.
Integrated high efficiency
LED light source. Bidirectional emission
for grazing light effects. Electronic driver
integrated in the fixture.*



Dimensioni / Dimensions

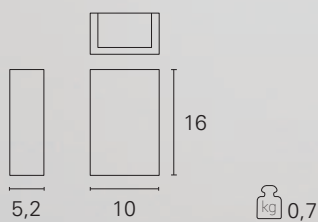

Gesso
Plaster



Oberon

Versione Model	Codice Code	Colore Finishing	Potenza / Flusso Effettivo Power / Lumen Output	CCT CCT	Sorgente Source	Alimentazione Power feeding	Classe energetica Energy Label	IP IP
Wall mounting - Uplight / Downlight	PAR321	Bianco / White	2x 3 W / 300 lm	3000 K	Power LED	220÷240 V - class I	LED	IP20

Polaris

⊕ 220÷240 V Power Led

Apparecchio da parete.

Corpo in gesso liscio bianco
verniciabile esternamente.

Schermo diffondente
e frontale antiabbagliamento.

Sorgente LED ad alta efficienza integrata.

Emissione bidirezionale per effetti di luce
radente sulla parete. Driver elettronico
integrato nell'apparecchio.

*Wall luminaire. White polished plaster
body externally paintable.*

Front antiglare diffuser.

Integrated high efficiency

*LED light source. Bidirectional emission
for grazing light effects. Electronic driver
integrated in the fixture.*



Dimensioni / Dimensions

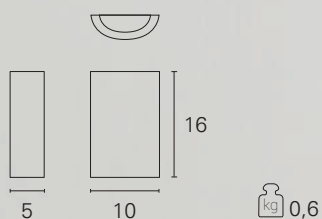

Gesso
Plaster



Boreale

Versione Model	Codice Code	Colore Finishing	Potenza / Flusso Effettivo Power / Lumen Output	CCT CCT	Sorgente Source	Alimentazione Power feeding	Classe energetica Energy Label	IP IP
Wall mounting - Uplight / Downlight	PAR320	Bianco / White	2x 3 W / 300 lm	3000 K	Power LED	220÷240 V - class I	LED	IP20

Eli

⊕ 220÷240 V CoB Led

Apparecchio da parete. Corpo in gesso liscio bianco verniciabile esternamente. Schermo diffondente e frontale antiabbagliamento. Sorgente LED ad alta efficienza integrata. Emissione bidirezionale per effetti di luce radente sulla parete. Driver elettronico integrato nell'apparecchio.

Wall luminaire. White polished plaster body externally paintable. Front antiglare diffuser. Integrated high efficiency LED light source. Bidirectional emission for grazing light effects. Electronic driver integrated in the fixture.



Dimensioni / Dimensions

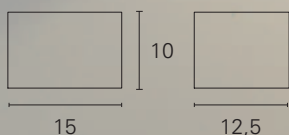

kg 1,5

Gesso
Plaster



Eli

Versione Model	Codice Code	Colore Finishing	Potenza / Flusso Effettivo Power / Lumen Output	CCT CCT	Sorgente Source	Alimentazione Power feeding	Classe energetica Energy Label	IP IP
Wall mounting - Downlight	PAR10325	Bianco / White	5 W / 220 lm	3000 K	CoB LED	220÷240 V - class I	LED	IP20

Eclis

⊕ 220÷240 V CoB Led

Apparecchio da parete con grado di protezione IP54. Realizzato con corpo in alluminio verniciato e schermo in materiale plastico. È equipaggiato con sorgente CoB LED ad alta efficienza e driver integrato. L'apparecchio è dotato di testa girevole che, ruotando sull'asse orizzontale, permette di creare effetti di luce personalizzati sulla parete.

Wall-mounted luminaire with IP54 protection degree. Made with painted aluminium body and plastic screen. It is equipped with a high efficiency CoB LED source and integrated driver. The device is equipped with a swivel head which, by rotating on the horizontal axis, allows you to create personalized light effects on the wall.



Dimensioni / Dimensions

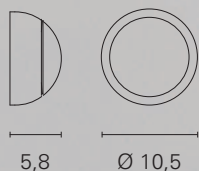

kg 0,6



Eclis

IP54

Versione Model	Codice Code	Colore Finishing	Potenza / Flusso Effettivo Power / Lumen Output	CCT CCT	Sorgente Source	Alimentazione Power feeding	Classe energetica Energy Label	IP IP
Wall mounting - Ø 10,5 cm.	PAR00075	Bianco / White	4 W / 250 lm	3000 K	CoB LED	220÷240 V - class I	LED	IP54

Fast

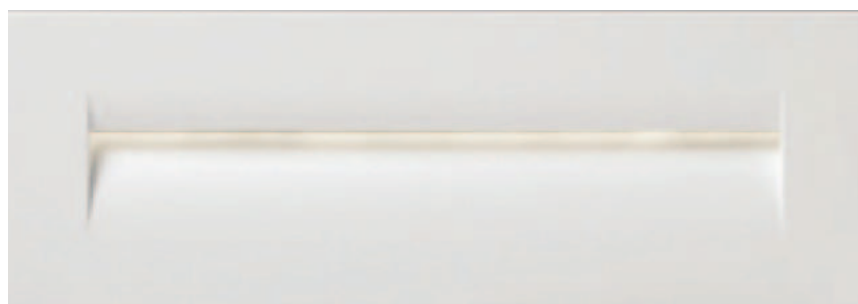
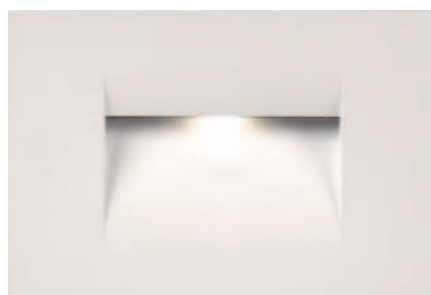

⊕ 220÷240 V SMD Led IP65 3 YEARS WARRANTY

Gli apparecchi segnapasso da parete FAST permettono di illuminare i percorsi con una luce confortevole e priva di abbagliamento. Tutte le versioni sono IP65 e sono installabili sia in ambienti interni che in outdoor. Sempre con driver incluso, Fast è disponibile in diverse configurazioni: con ottiche asimmetriche per l'illuminazione diretta del pavimento, o con ottiche diffondenti per luce generalmente soffusa; fra queste, la versione "no frame" è completa di vetro satinato montato su telaio non in vista. Completa la gamma la versione per luce d'emergenza completa di led di segnalazione; tutte le versioni da 3,6 W sono installabili direttamente nella scatola standard 503 per ottimizzare le soluzioni impiantistiche; le placchette estetiche sono realizzate in pressofusione di alluminio, verniciate nei colori bianco e grigio.

FAST wall-mounted pathway luminaires allow you to illuminate paths with a light comfortable and glare-free. All versions are IP65 and can be installed both indoors and outdoors. Always with driver included, Fast is available in different configurations: with asymmetrical optics for direct floor lighting, or with diffusing optics for generally soft light; among these, the "no frame" version is complete with frosted glass with frame totally hidden. The range is completed by the version for emergency light complete with signaling LED; all 3.6 W versions can be installed directly in the standard 503 box to optimize the system solutions; the plates are made of die-cast aluminum, coated in white and gray.



Fast

Ottiche / Optics

asimmetrico / *asymmetric*

3,6W - 45°

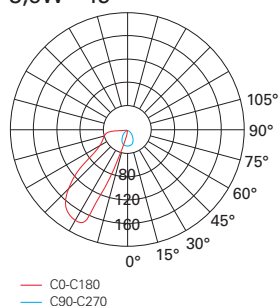

8,5W - 55°

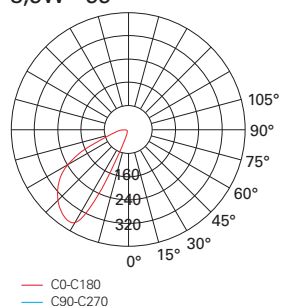

diffusore / *diffuser*

3,6W - 150°

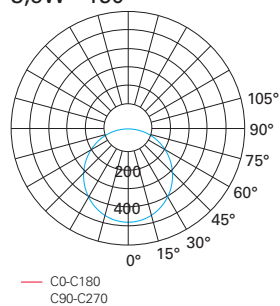

3,6W - 55°

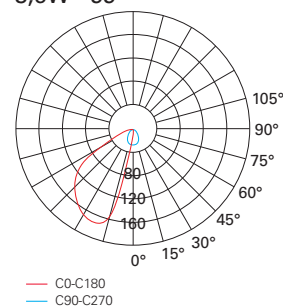

Dimensioni / Dimensions

asimmetrico / *asymmetric*

Orizzontale / *Horizontal*

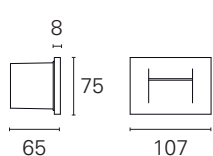

0,30

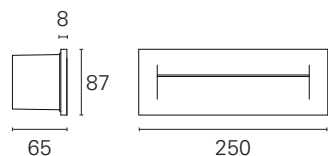

0,70

diffusore / *diffuser*

Telaio a vista / *Visible frame*

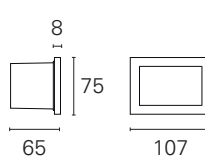

0,30

Verticale / *Vertical*

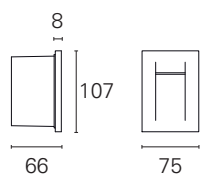

0,30

Telaio nascosto / *Hidden frame*

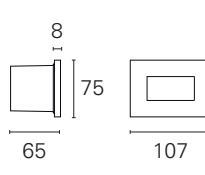

0,30

Fast Emergenza / *Emergency*

La versione di Fast Emergenza può funzionare sia in modalità per luce "permanente" sia in modalità per luce "non permanente". La selezione della modalità avviene tramite un apposito miniswitch posizionato sul retro dell'apparecchio. Fast Emergenza è completo di led di segnalazione verde a vista per l'indicazione dello stato di alimentazione; è dotato di converter e batteria 3.6V 0.6Ah NiCd che garantisce un'autonomia di 1 h. ricaricandosi in 24 h. Fast Emergenza si installa in scatola standard 503 e si alimenta in Classe II a 230 VAC 50/60 Hz).

The Fast Emergency version can work both in "permanent" and "non-permanent" lighting mode. The mode is selected by a specific miniswitch located on the back of the fixture. Fast Emergency is complete with visible green signaling LED to indicate the power supply status; it is equipped with a converter and 3.6V 0.6Ah NiCd battery that ensure 1 h. of autonomy and a recharging time of 24 h. Fast Emergenza is installed in a standard 503 box and is fed in Class II at 230 VAC 50/60 Hz).

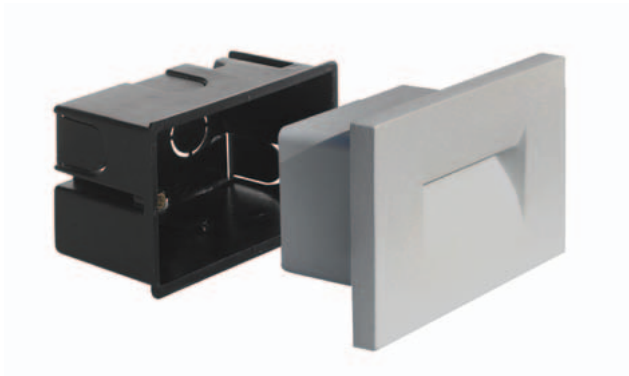

Compatibile
con scatola 503
Suitable
for 503 box



Fast Asimmetrico / *Asymmetric*

220 ÷ 240 V - **IP65**

versione <i>version</i>	modello <i>type</i>	potenza <i>power</i>	codice <i>code</i>	CCT <i>CCT</i>	flusso apparecchio <i>light output</i>	ottica <i>optic</i>	colore <i>colour</i>
Orizzontale <i>Horizontal</i>	SMD Led	3,6 W	INC59000	3000 K	60 lm	AS	bianco / <i>white</i>
			INC59001	3000 K	60 lm	AS	grigio / <i>grey</i>
	SMD Led	8,5 W	INC59004	3000 K	205 lm	AS	bianco / <i>white</i>
			INC59005	3000 K	205 lm	AS	grigio / <i>grey</i>
Verticale <i>Vertical</i>	SMD Led	3,6 W	INC59002	3000 K	70 lm	AS	bianco / <i>white</i>
			INC59003	3000 K	70 lm	AS	grigio / <i>grey</i>

Fast Diffusore / *Diffuser*

220 ÷ 240 V - **IP65**

versione <i>version</i>	modello <i>type</i>	potenza <i>power</i>	codice <i>code</i>	CCT <i>CCT</i>	flusso apparecchio <i>light output</i>	ottica <i>optic</i>	colore <i>colour</i>
Telaio a vista <i>Visible frame</i>	SMD Led	3,6 W	INC59010	3000 K	40 lm	150°	bianco / <i>white</i>
			INC59011	3000 K	40 lm	150°	grigio / <i>grey</i>
Telaio nascosto <i>Hidden frame</i>	SMD Led	3,6 W	INC59006	3000 K	40 lm	150°	bianco / <i>white</i>

Fast Emergenza / *Emergency*

220 ÷ 240 V - **IP20**

versione <i>version</i>	modello <i>type</i>	potenza <i>power</i>	codice <i>code</i>	autonomia <i>operation time</i>	tempo di accensione <i>switching time</i>	tempo di ricarica <i>recharging time</i>	colore <i>colour</i>
Orizzontale <i>Horizontal</i>	SMD Led	3,6 W	INC59600EM	1 ora / 1 hour	0,5 sec	24 h.	bianco / <i>white</i>

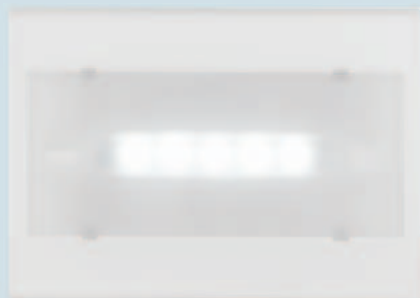

Dimensioni / *Dimensions*

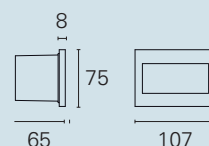

kg 0,30

Polka

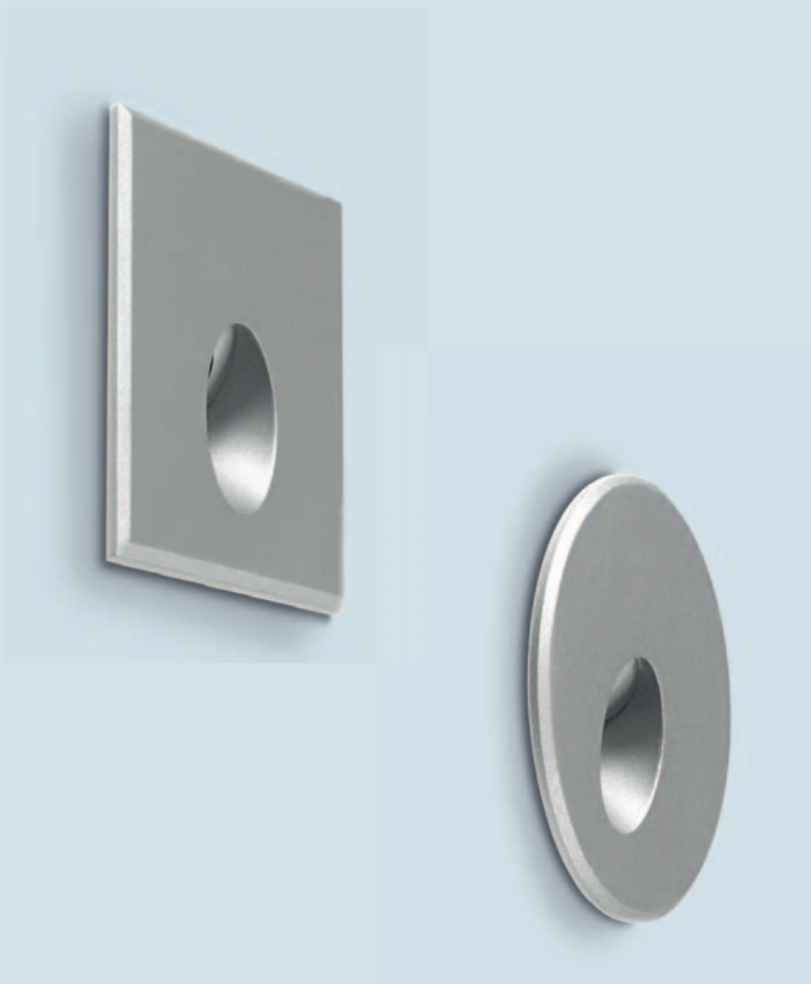

220÷240 V

Power Led

IP65

3 YEARS WARRANTY

Polka è un segnapasso per l'illuminazione dei percorsi in interni e in esterni. Realizzato in pressofusione di alluminio verniciata, è dotato di cavo di alimentazione in neoprene tipo H05RN-F. Polka è particolarmente indicato per le installazioni in outdoor. Grazie alla sua emissione asimmetrica e alla sorgente led arretrata nel corpo, illumina il pavimento in modo confortevole e senza abbagliamento. E' completo di pozzetto di installazione in PVC.

Polka is a path lighter for indoor and outdoor applications. Painted die-cast aluminum, it is equipped with a H05RN-F neoprene power cable. It is particularly suitable for outdoor installations. Thanks to its asymmetrical emission and to the led source hidden in the body, it illuminates the floor comfortably and without glare. PVC housing included.



Dimensioni / Dimensions

Rounded 3W

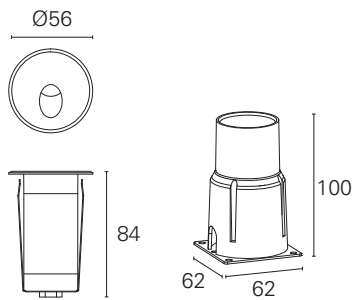

kg 0,32

Squared 3W

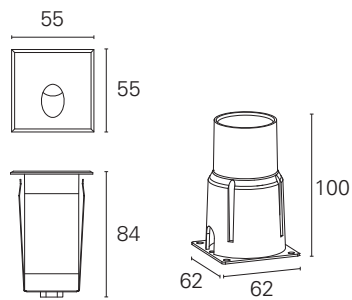

kg 0,32

Ottiche / Optics

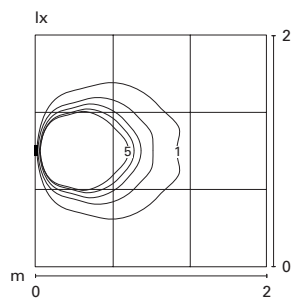
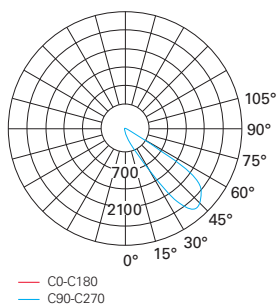

Polka

220 ÷ 240 V - IP65

Versione Model	Potenza Power	Dimensione Size	Codice Code	CCT CCT	Flusso apparecchio Light output	Ottica Optic	IP IP	IK IK	Colore Colour
Tondo <i>Rounded</i>	3 W	Ø 56 mm.	EST54017	3000 K	120 lm	30°	IP65	IK10	grigio / grey
			EST54015	4000 K	150 lm	30°	IP65	IK10	grigio / grey
Quadrato <i>Squared</i>	3 W	55 x 55 mm.	EST54018	3000 K	150 lm	30°	IP65	IK10	grigio / grey
			EST54016	4000 K	150 lm	30°	IP65	IK10	grigio / grey



Installabile in parete piena con pozzetto in dotazione, oppure in parete a pannelli di spessore minimo 10 mm. senza pozzetto.

Suitable for mounting in concrete wall (sleeve included) or in vertical panels of minimum thickness 10 mm. (sleeve not needed).

Lupin

⊕ 220÷240 V GU10

La serie di apparecchi Lupin è realizzata in alluminio verniciato bianco opaco. I corpi ottici sono completi di frontale antiabbagliamento e sono equipaggiati con driver elettronico integrato e attacco lampada GU10. Lupin è progettato illuminare con effetti di luce spot; la gamma prevede diverse configurazioni per l'installazione a parete o a soffitto, e si completa con le versioni in coordinato per l'installazione a sospensione.

The Lupin luminaire series is made of matt white painted aluminium. The optical bodies are complete with anti-glare front and are equipped with an integrated electronic driver and GU10 lamp socket. Lupine is designed to illuminate with concentrated light effects; the range includes different configurations for wall or ceiling installation and is completed with coordinated versions for suspended installation.



Dimensioni / Dimensions

Ceiling Downlight

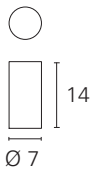

0,4

Wall Uplight / Downlight

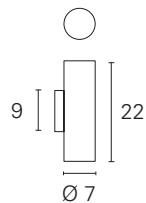

0,6

Ceiling 1x Spot

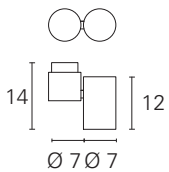

0,6

Ceiling 2x Spots

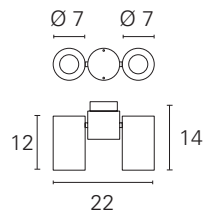

0,9

Lupin Pendant
pag. 430



Lupin

Versione Model	Codice Code	Colore Finishing	Potenza / Flusso Effettivo Power / Lumen Output	CCT CCT	Sorgente Source	Alimentazione Power feeding	Classe energetica Energy Label	IP IP
Ceiling mounting - Downlight	PAR182	Bianco / White	7 W / 550 lm	3000 K	LED GU10	220÷240 V - class I	LED	IP20
Ceiling mounting - 1x Spot	PAR185	Bianco / White	7 W / 550 lm	3000 K	LED GU10	220÷240 V - class I	LED	IP20
Wall mounting - Uplight / Downlight	PAR00018	Bianco / White	2x 7 W / 2x 550 lm	3000 K	LED GU10	220÷240 V - class I	LED	IP20
Ceiling mounting - 2x Spots	PAR00021	Bianco / White	2x 7 W / 2x 550 lm	3000 K	LED GU10	220÷240 V - class I	LED	IP20

Barro

⊕ 220÷240 V GU10

La serie di apparecchi Barro è realizzata in alluminio verniciato bianco opaco. I corpi ottici sono completi di frontale antiabbagliamento e sono equipaggiati con driver elettronico integrato e attacco lampada GU10. Barro è progettato per illuminare con effetti di luce focalizzati; comprende una gamma con due diverse configurazioni: a corpo singolo o a doppio corpo indipendente, installabili a parete e a soffitto.

The Barro luminaire series is made of matt white painted aluminium. The optical bodies are complete with anti-glare front and are equipped with an integrated electronic driver and GU10 lamp socket. Barro is designed to illuminate spotlight effects and includes a range with different configurations with single body or double independent body, which can be installed both on the wall and on the ceiling.



Barro

Versione Model	Codice Code	Colore Finishing	Potenza / Flusso Effettivo Power / Lumen Output	CCT CCT	Sorgente Source	Alimentazione Power feeding	Classe energetica Energy Label	IP IP
Wall mounting - 1x Spot	PAR243	Bianco / White	7 W / 550 lm	3000 K	LED GU10	220÷240 V - class I	LED	IP20
Wall mounting - 2x Spots	PAR00024	Bianco / White	2x 7 W / 2x 550 lm	3000 K	LED GU10	220÷240 V - class I	LED	IP20



Dimensioni / Dimensions

Wall 1x Spot

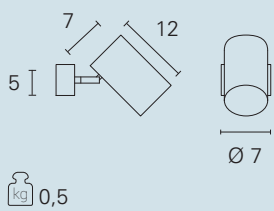

Wall 2x Spots

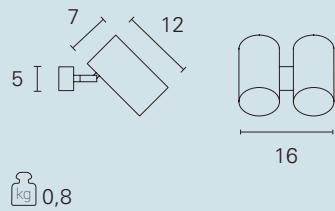

Dippy

⊕ 220÷240 V CoB Led

Dippy è un proiettore installabile a parete o a soffitto. È realizzato in metallo verniciato bianco opaco o nero opaco ed è completo di schermo diffondente. Il particolare piano inclinato che ne caratterizza il design permette l'orientabilità del proiettore di 90°. Equipaggiato con sorgente CoB LED ad alta efficienza e driver integrato si utilizza per effetti di luce spot.

Dippy is a projector that can be installed on the wall or ceiling. It is made of matt white or matt black painted metal and is complete with a diffusing screen. The peculiar inclined plane that characterizes its design allows the projector to be adjusted by 90°. Equipped with a high efficiency CoB LED source and integrated driver, it is used to obtain spotlight effects.



Dimensioni / Dimensions

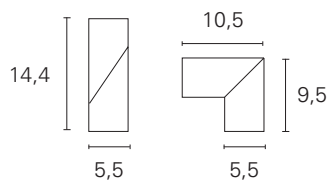

kg 1,0

Ottiche / Optics

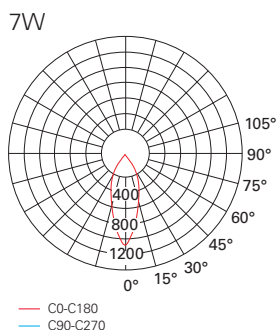

Dippy

Versione Model	Codice Code	Colore Finishing	Potenza / Flusso Effettivo Power / Lumen Output	CCT CCT	Sorgente Source	Alimentazione Power feeding	Classe energetica Energy Label	IP IP
Wall / Ceiling mounting	PAR281	Nero / Black	7 W / 600 lm	3000 K	CoB LED	220÷240 V - class I	LED	IP40
Wall / Ceiling mounting	PAR282	Bianco / White	7 W / 600 lm	3000 K	CoB LED	220÷240 V - class I	LED	IP40

Pako

⊕ 220÷240 V SMD Led

Pako è un proiettore installabile a parete e a soffitto. È realizzato in metallo verniciato bianco opaco o nero opaco ed è completo di schermo diffondente. Il corpo principale si caratterizza per il taglio inclinato sul quale la testa ottica può ruotare di 90°. Pako è completo di LED ad alta efficienza e driver integrato, si utilizza per effetti di luce spot e si abbina alla serie di apparecchi a sospensione Stek.

Pako is a projector for wall mounting or ceiling mounting. It is made of matt white or matt black painted metal and is complete with a diffusing screen. The main body is characterized by the inclined cut on which the optical head can rotate 90°.

Pako is complete with high efficiency LEDs and integrated driver, it is used for spotlight effects and is combined with the Stek pendant fixture series.



Dimensioni / Dimensions

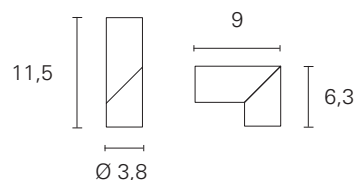

kg 0,3

Ottiche / Optics

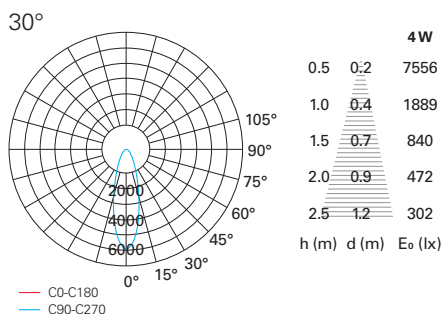

Stek Pendant
pag. 428

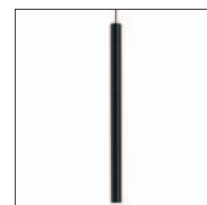

Pako

Versione Model	Codice Code	Colore Finishing	Potenza / Flusso Effettivo Power / Lumen Output	CCT CCT	Sorgente Source	Alimentazione Power feeding	Classe energetica Energy Label	IP IP
Wall / Ceiling mounting	SOP08111	Bianco / White	4 W / 320 lm	3000 K	SMD LED	220÷240 V - class I	LED	IP20
Wall / Ceiling mounting	SOP08121	Nero / Black	4 W / 320 lm	3000 K	SMD LED	220÷240 V - class I	LED	IP20

Professional

◆ 12V GU5,3

Sistema di cavi in bassissima tensione. Spot in metallo con portalampada GU 5,3 con possibilità di orientamento sul piano verticale e orizzontale. Per effetti di luce di accento. Driver remoto non incluso. Sorgente GU 5,3 non inclusa.

Very low voltage cable system. Metal spot with GU 5,3 lamp holder with possibility of vertical and horizontal orientation. For accent lighting effects. Remote driver not included. OJ 5.3 source not included.

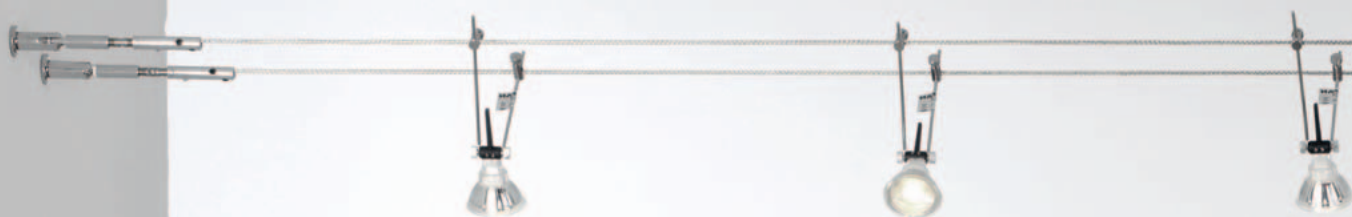

Versione <i>Model</i>	Codice <i>Code</i>	Kit completo di: <i>Full Kit composed by</i>
Kit Professional	CAB1016	<p>6x Spot completi di lampada LED GU5,3 - 7 W / 3000 K (6x CAB1031 + 6x LED1071) 1x Driver 50 W / 12 V DC completo di box in metallo verniciato bianco (1x DRV2004 + 1x CAB1051) 1x Coppia di morsetti di alimentazione (1x CAB1008) 1x Coppia di attacchi a parete (1x CAB1000) 1x Coppia di tiranti regolabili per attacco a parete (1x CAB1001) 10 metri di cavo non isolato, finitura "treccia", Ø 4mm. (1x CAB1025)</p> <p><i>6x Spots lamp included LED GU5,3 - 7 W / 3000 K (6x CAB1031 + 6x LED1071) 1x Driver 50 W / 12 V DC, wall mounting metal cover included, white painted (1x DRV2004 + 1x CAB1051) 1x Live end connectors (1x CAB1008) 1x Couple of wall mounting fits (1x CAB1000) 1x Couple of wall mounting adjustable tensors (1x CAB1001) 10 meters not insulated wire, tinned copper plait, Ø 4mm. (1x CAB1025)</i></p>



Dimensioni / Dimensions

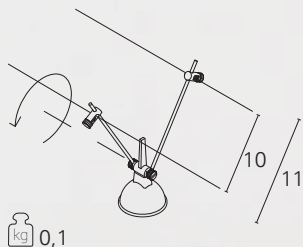

Professional

Versione Model	Codice Code	Potenza / Flusso Effettivo Power / Lumen Output	Sorgente Source	Alimentazione Power feeding	Classe energetica Energy Label	IP IP
Wall / Ceiling mounting	CAB1031	lamp not included	LED / HRGS GU5,3	12 V - class III	A++...D	IP20

Professional

Codice Code	Note
CAB1025	10 metri / meters
CAB1026	20 metri / meters
CAB1027	50 metri / meters

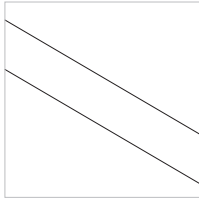

Cavo non isolato in rame stagnato, finitura "treccia" con diametro di 4mm.

Not insulated wire, tinned copper plait, diameter 4mm.

Nicht isoliertes Kabel aus verzinnem Kupfer, "geflochtene". Feinbearbeitung mit einem Durchmesser von 4mm.

Câble non isolé en cuivre étamé, finition « tresse », avec un diamètre de 4mm.

Cable de cobre sin aislamiento de estañado acabado en "trenza" de 4mm de diámetro.

Codice Code	Colore Finishing
CAB1000	chrome

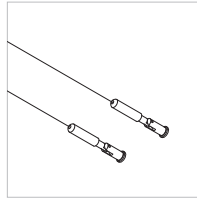

Coppia di attacchi parete (2 pcs).

Wall mounting Kit (2 pcs).

Doppelter Wandanschluss (2 Stk).

Paire de fixations murales (2 éléments).

Pareja de monturas de pared (2 pcs).

Codice Code	Colore Finishing
CAB1001	chrome

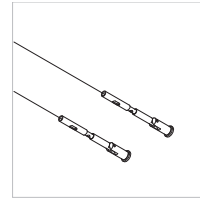

Coppia di tiranti regolabili. Adattabili per cavo in rame (2 pcs - 6mm).

Adjustable tensors (2 pcs). Suitable for copper wire (2 pcs - 6mm).

Zwei regulierbare Spannkabel. Anpassbar an Kupferkabel (2 Stk. - 6mm).

Paire de tirants réglables. Convient aux câbles en cuivre (2 éléments - 6mm).

Pareja de suspensiones ajustables. Adaptable para cable (2 pcs -6mm).

Codice Code	Colore Finishing
CAB1002	chrome

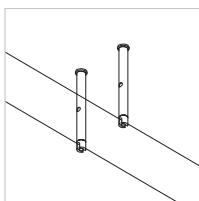

Coppia di distanziatori parete/soffitto (2 pcs - 15cm).

Spacers wall/ceiling (2 pcs - 15cm).

Zwei Abstandshalter für die Wand/ Decke (2 Stk. - 15cm).

Paire d'entretoises mur/plafond (2 éléments - 15cm).

Pareja de espaciadores de pared/techo (2 pcs -15cm).

Codice Code	Colore Finishing
CAB1003	chrome

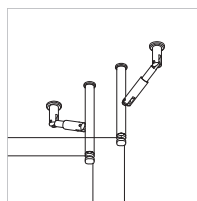

Coppia di attacchi angolari parete/soffitto (2pcs - 15cm). Consente di realizzare curve di diversa ampiezza.

Wall/ceiling mounting (2 pcs - 15cm). For curve lines of different widths.

Zwei Eckanschlüsse Wand/ Decke (2 Stk. 15cm). Sie erlauben verschieden breite Kurven zu realisieren.

Paire de fixations d'angle mur/plafond (2 éléments - 15cm). Permet de réaliser des courbes de tailles différentes.

Pareja de montajes angulares de pared / techo (2pcs -15cm). Permiten crear curvas de diferentes tamaños.

Codice Code	Colore Finishing	Note
CAB1004	chrome	elettrificata / live
CAB1005	chrome	Isolata / insulated

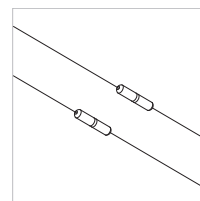

Coppia di giunti elettrificati o isolati (2 pcs).

Live or insulated joint connectors (2 pcs).

Zwei elektrifizierte oder isolierte Anschlüsse (2 Stk).

Paire de joints électrififiés ou isolés (2 éléments).

Pareja de articulaciones electrificadas o aisladas (2 pcs).

Codice Code	Colore Finishing	Note Note
CAB1006	chrome	elettrificata / live
CAB1007	chrome	Isolata / insulated

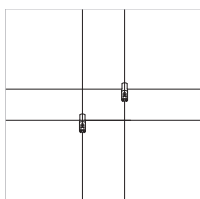

Coppia connessione "X" elettrificata o isolata (2 pcs).

Live or insulated "X" joint connectors (2 pcs).

Zwei elektrifizierte oder isolierte X-Verbindungen (2 Stk).

Paire de connexion "X" électrifiée ou isolée (2 éléments).

Pareja de conectores "X" electrificados o aislados (2 pcs).

Codice Code	Colore Finishing
CAB1008	chrome

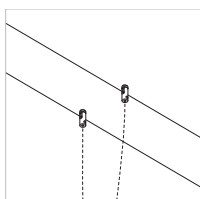

Coppia di morsetti di alimentazione (2 pcs).

Live end connectors (2 pcs).

Zwei Spannungsversorgungsanschlüsse (2 Stk).

Paire de bornes d'alimentation (2 éléments).

Pareja de terminales de alimentación (2 pcs).

Codice Code	Colore Finishing
CAB1009	chrome

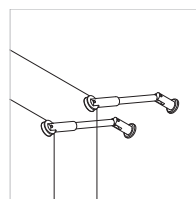

Coppia di distanziatori regolabili con carrucola (2 pcs). Consentono di creare angoli nelle linee.

Adjustable spacers (2 pcs) with pulley. For lines with angles.

Zwei regulierbare Abstandshalter mit Rolle (2 Stk). Sie erlauben, Ecken in das System zu bringen.

Paire d'entretoises réglables avec poulie (2 éléments). Permettent de créer des angles dans les lignes.

Pareja de separadores ajustables con polea (2 pcs). Permite crear ángulos rectos.

Codice Code	Colore Finishing
CAB1010	chrome

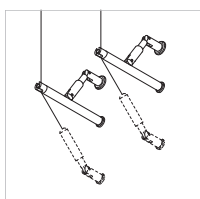

Coppia di distanziatori parete/soffitto (2 pcs - 15cm). Consente di realizzare inizio e fine tesata.

Wall/ceiling mounting (2 pcs - 15cm). For start/end of an installation.

Zwei Anschlüsse Wand/ Decke (2 Stk - 15cm). Diese erlauben, den Beginn und das Ende des Seilsystems zu realisieren.

Paire de fixations mur/plafond (2 éléments - 15cm). Permet de fixer un câble tendu aux deux extrémités.

Pareja de montajes de pared/techo (2 pcs - 15 cm). Permiten colocarla con seguridad.

Codice Code	Colore Finishing
CAB1051	white
CAB1052	silver

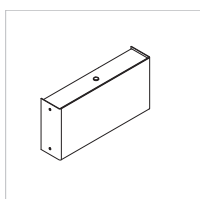

Box in metallo applicazione parete per alimentatore.

Wall mounting metal cover for feeding unit.

Metallkasten zur Anbringung an der Wand für Netzteil.

Boîtier métallique application au mur pour conducteur.

Caja de metal, aplicación pared, para fuente de alimentación.

Berlin

□ 220÷240 V Power Led

Lampada da parete per lettura. Corpo in alluminio verniciato. Braccio flessibile ed orientabile. Sorgente LED ad alta efficienza integrata. Per luce diretta per accenti luminosi. Driver elettronico integrato nell'apparecchio. Emissione con fascio di apertura a 30°. Interruttore On/Off e presa USB integrata nella parte inferiore della basetta di fissaggio.

Wall reading lamp. Painted aluminium body. Adjustable and flexible arm. Integrated high efficiency LED light source. Direct lighting for bright accents. Electronic driver integrated in the fixture. Beam angle 30°. On/Off and USB on the base.



Dimensioni / Dimensions

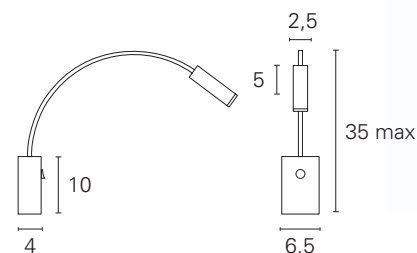

kg 0,5



Berlin

Versione Model	Codice Code	Colore Finishing	Potenza / Flusso Effettivo Power / Lumen Output	CCT CCT	Sorgente Source	Alimentazione Power feeding	Classe energetica Energy Label	IP IP
Flexible Arm	RGL02110	Bianco / White	3 W / 190 lm	3000 K	Power LED	220÷240 V - class II	LED	IP20
Flexible Arm	RGL02120	Nero / Black	3 W / 190 lm	3000 K	Power LED	220÷240 V - class II	LED	IP20
Flexible Arm	RGL02160	Nichel / Nickel	3 W / 190 lm	3000 K	Power LED	220÷240 V - class II	LED	IP20

London

□ 220÷240 V Power Led

Lampada da parete per lettura. Corpo in alluminio verniciato. Braccio flessibile ed orientabile. Sorgente LED ad alta efficienza integrata. Per luce diretta per accenti luminosi. Driver elettronico integrato nell'apparecchio. Emissione con fascio di apertura a 30°. Interruttore On/Off sulla base.

Wall reading lamp. Painted aluminium body. Adjustable and flexible arm. Integrated high efficiency LED light source. Direct lighting for bright accents. Electronic driver integrated in the fixture. Beam angle 30°. On/Off on the base.

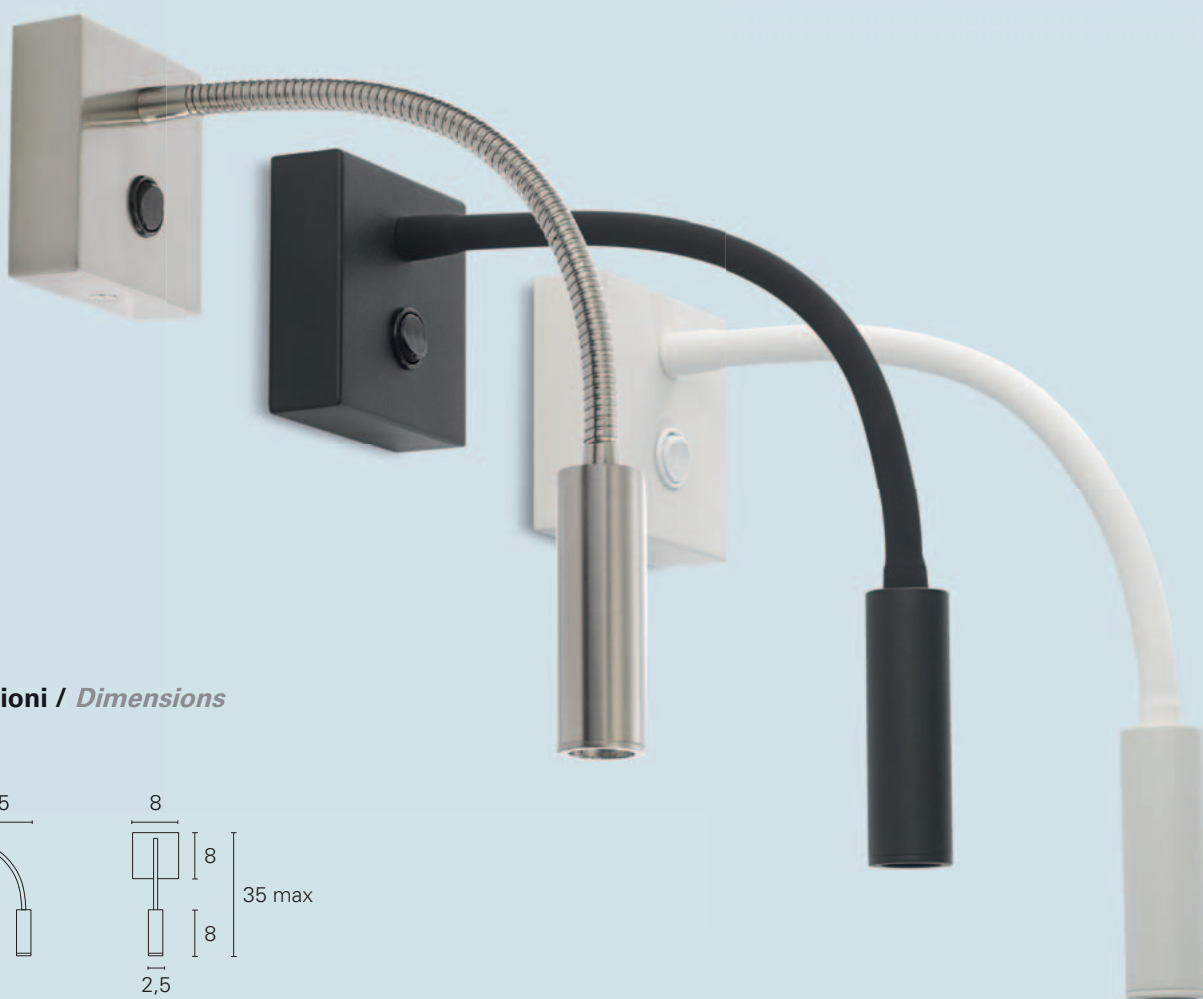

Dimensioni / Dimensions

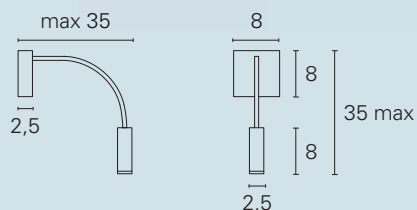

kg 0,4

London

Versione Model	Codice Code	Colore Finishing	Potenza / Flusso Effettivo Power / Lumen Output	CCT CCT	Sorgente Source	Alimentazione Power feeding	Classe energetica Energy Label	IP IP
Flexible Arm	RGL03110	Bianco / White	3 W / 190 lm	3000 K	Power LED	220÷240 V - class II	LED	IP20
Flexible Arm	RGL03120	Nero / Black	3 W / 190 lm	3000 K	Power LED	220÷240 V - class II	LED	IP20
Flexible Arm	RGL03160	Nichel / Nickel	3 W / 190 lm	3000 K	Power LED	220÷240 V - class II	LED	IP20

Paris

□ 220÷240 V Power Led

Apparecchio da parete. Corpo in alluminio verniciato o cromato. Braccio flessibile ed orientabile. Sorgente LED ad alta efficienza integrata. Per luce diretta per accenti luminosi. Driver elettronico integrato nell'apparecchio. Interruttore On/Off sulla base.

Wall luminaire. Painted or chromed aluminium body. Adjustable and flexible arm. Integrated high efficiency LED light source. Direct lighting for bright accents. Electronic driver integrated in the fixture. On/Off on the base.

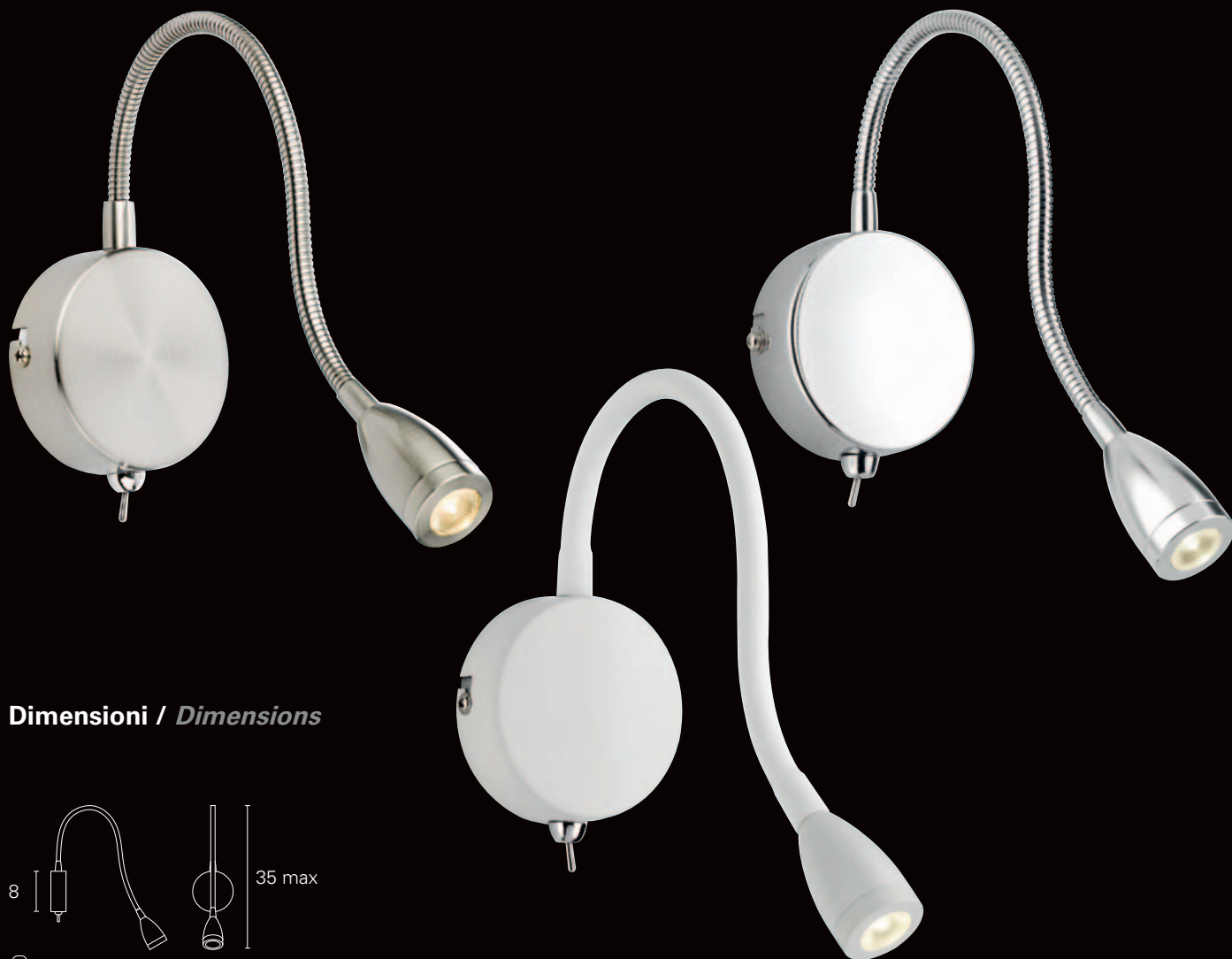

Dimensioni / Dimensions

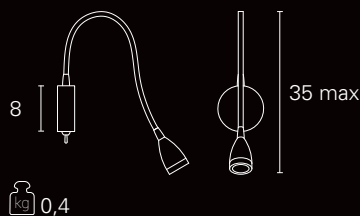

Paris

Versione Model	Codice Code	Colore Finishing	Potenza / Flusso Effettivo Power / Lumen Output	CCT CCT	Sorgente Source	Alimentazione Power feeding	Classe energetica Energy Label	IP IP
Flexible Arm	PAR00254	Bianco / White	2 W / 150 lm	3000 K	Power LED	220÷240 V - class II	LED	IP20
Flexible Arm	PAR00255	Cromo / Chrome	2 W / 150 lm	3000 K	Power LED	220÷240 V - class II	LED	IP20
Flexible Arm	PAR00256	Acciaio / Steel	2 W / 150 lm	3000 K	Power LED	220÷240 V - class II	LED	IP20

Cama

⊕ 220÷240 V Power Led

Lampada da parete per lettura. Corpo in alluminio verniciato a sezione tonda o quadrata. Testa orientabile sul piano orizzontale e sul piano verticale per il puntamento della luce. Sorgente LED ad alta efficienza e driver elettronico integrato nell'apparecchio. Interruttore On/Off sulla base.

Wall lamp for reading. Painted aluminium body with round or square section. Head adjustable on the horizontal plane and on the vertical plane for pointing the light. High efficiency LED source and electronic driver integrated in the fixture. On/Off switch on the base.



Dimensioni / Dimensions

Squared Wall mounting

Rounded Wall mounting

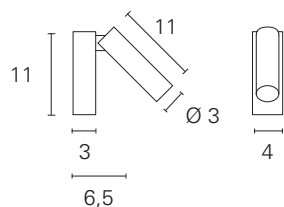
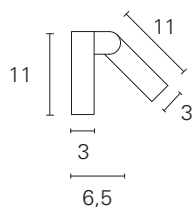

kg 0,5

kg 0,5

Cama

Versione Model	Codice Code	Colore Finishing	Potenza / Flusso Effettivo Power / Lumen Output	CCT CCT	Sorgente Source	Alimentazione Power feeding	Classe energetica Energy Label	IP IP
Squared Wall mounting	PAR00035	Bianco / White	2 W / 130 lm	3000 K	Power LED	220÷240 V - class I	LED	IP20
Rounded Wall mounting	PAR00037	Bianco / White	2 W / 130 lm	3000 K	Power LED	220÷240 V - class I	LED	IP20

Soft Wall

⊕ 220÷240V E27

Apparecchio da parete. Paralume in tessuto. Struttura in metallo cromato. Per lampade con attacco E27 o equivalenti a LED. Per effetti di luce diffusa. Lampada non inclusa. Interruttore On/Off sulla base.

Wall luminaire. Fabric shade. Chrome body. For E27 light bulb or LED equivalent. For diffused light effects. Bulb not included. Switch On/Off on the base.



Dimensioni / Dimensions

Double arm

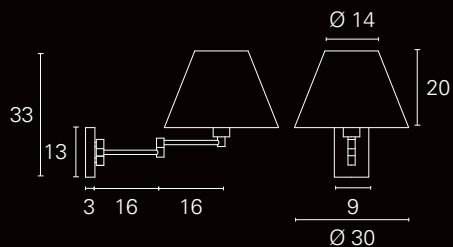

kg 1,6

Single arm

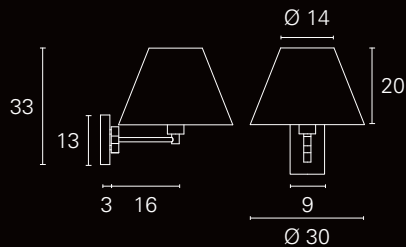

kg 1,3

Soft Floor
pag. 510



Soft Table
pag. 528



Soft Wall

Versione Model	Codice Code	Colore Finishing	Potenza / Flusso Effettivo Power / Lumen Output	Sorgente Source	Alimentazione Power feeding	Classe energetica Energy Label	IP IP
Adjustable Arm - Double	PAR097	Cromo - Bianco / Chrome - White	max. 15 W (not included)	LED / FBT E27	220÷240 V - class I	A++...D	IP20
Adjustable Arm - Single	PAR098	Cromo - Bianco / Chrome - White	max. 15 W (not included)	LED / FBT E27	220÷240 V - class I	A++...D	IP20

Tina

⊕ 220÷240 V E14

Apparecchio da parete. Corpo in metallo orientabile. Finitura cromo o ottone. Per lampade con attacco E14 o equivalenti a LED. Luce diretta a parete per l'illuminazione dei quadri. Lampada non inclusa.

Wall luminaire. Adjustable metal body. Chrome and brass finish. For E14 light bulb or LED equivalent. For direct lighting for paintings. Bulb not included.



Dimensioni / Dimensions

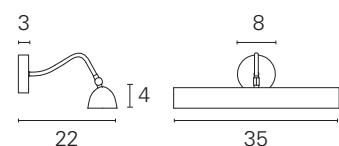

kg 0,8

Tina

Versione Model	Codice Code	Colore Finishing	Potenza / Flusso Effettivo Power / Lumen Output	Sorgente Source	Alimentazione Power feeding	Classe energetica Energy Label	IP IP
Wall mounting - 35 cm.	PAR155	Cromo / Chrome	2x max. 40 W (not included)	LED / IAA E14	220÷240 V - class I	A++...D	IP20
Wall mounting - 35 cm.	PAR156	Ottone / Brass	2x max. 40 W (not included)	LED / IAA E14	220÷240 V - class I	A++...D	IP20

Emma

⊕ 220÷240 V SMD Led

Apparecchio da parete. Corpo in metallo orientabile. Finitura cromo. Sorgente LED ad alta efficienza.
Per luce diretta per l'illuminazione dei quadri. Driver elettronico integrato nell'apparecchio.

*Wall luminaire. Adjustable metal body. Chrome finish. High efficiency LED light source. For direct lighting of paintings.
Electronic driver integrated in the fixture.*



Dimensioni / Dimensions

Wall l. 31 cm.

Wall l. 47 cm.

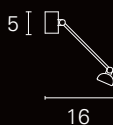
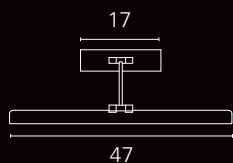
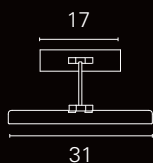

0,5 kg

0,6 kg

Emma

Versione Model	Codice Code	Colore Finishing	Potenza / Flusso Effettivo Power / Lumen Output	CCT CCT	Sorgente Source	Alimentazione Power feeding	Classe energetica Energy Label	IP IP
Wall mounting - 31 cm.	PAR00287	Cromo / Chrome	5 W / 320 lm	3000 K	SMD LED	220÷240 V - class I	LED	IP20
Wall mounting - 47 cm.	PAR00288	Cromo / Chrome	8 W / 510 lm	3000 K	SMD LED	220÷240 V - class I	LED	IP20

Susy

⊕ 220÷240 V SMD Led

Apparecchio da parete. Corpo in metallo orientabile. Finitura cromo. Sorgente LED ad alta efficienza. Per luce diretta per l'illuminazione dei quadri. Driver elettronico integrato nell'apparecchio.

Wall luminaire. Adjustable metal body. Chrome finish. High efficiency LED light source. For direct lighting of paintings. Electronic driver integrated in the fixture.

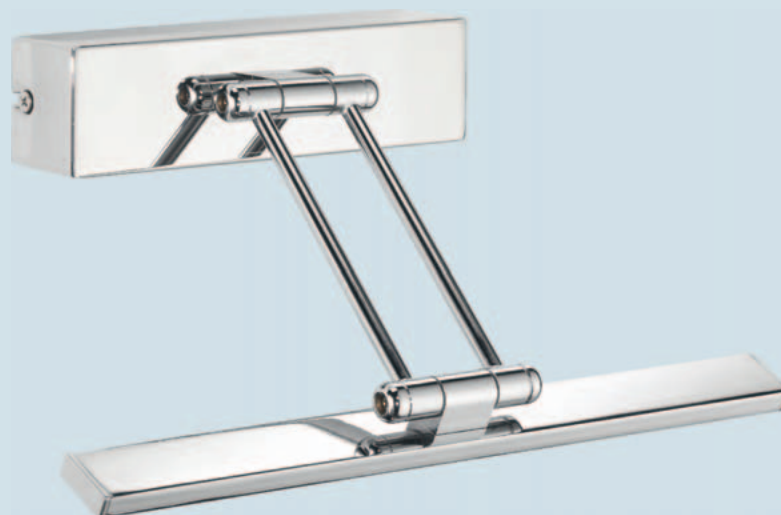

Dimensioni / Dimensions

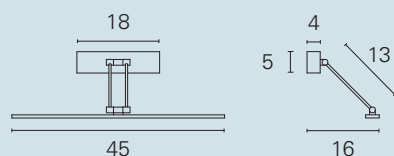

kg 0,7

Susy

Versione Model	Codice Code	Colore Finishing	Potenza / Flusso Effettivo Power / Lumen Output	CCT CCT	Sorgente Source	Alimentazione Power feeding	Classe energetica Energy Label	IP IP
Wall mounting - 45 cm.	PAR00223	Cromo / Chrome	8 W / 640 lm	3000 K	SMD LED	220÷240 V - class I	LED	IP20

Giuly

⊕ 220÷240 V SMD Led

Apparecchio da parete. Corpo in metallo orientabile. Finitura cromo. Sorgente LED ad alta efficienza. Per luce diretta per l'illuminazione dei quadri. Driver elettronico integrato nell'apparecchio.

Wall luminaire. Adjustable metal body. Chrome finish. High efficiency LED light source. For direct lighting of paintings. Electronic driver integrated in the fixture.

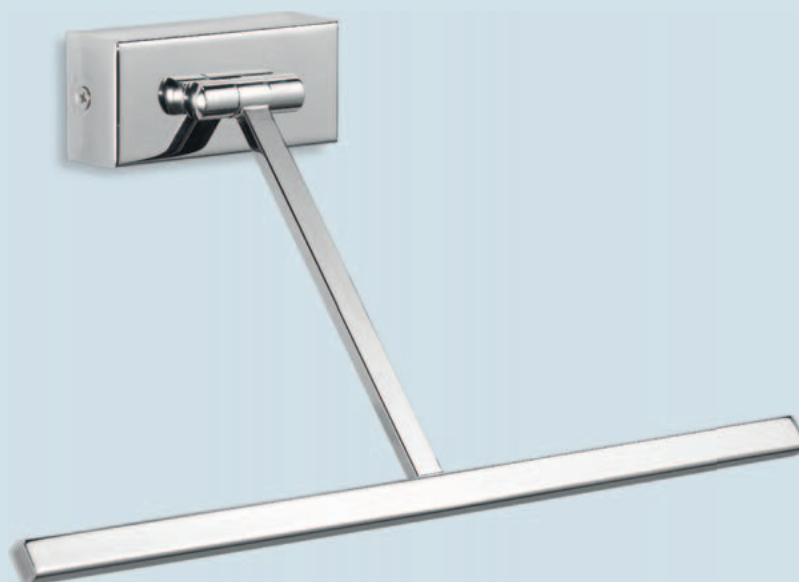

Dimensioni / Dimensions

Wall l. 34 cm.

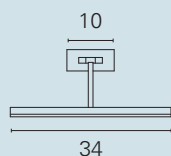

kg 0,6

Wall l. 46 cm.

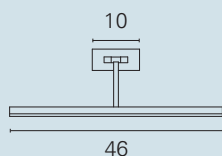

kg 0,7

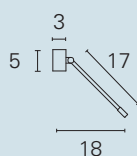

Giuly

Versione Model	Codice Code	Colore Finishing	Potenza / Flusso Effettivo Power / Lumen Output	CCT CCT	Sorgente Source	Alimentazione Power feeding	Classe energetica Energy Label	IP IP
Wall mounting - 34 cm.	PAR00226	Cromo / Chrome	5 W / 400 lm	3000 K	SMD LED	220÷240 V - class I	LED	IP20
Wall mounting - 46 cm.	PAR00227	Cromo / Chrome	7 W / 560 lm	3000 K	SMD LED	220÷240 V - class I	LED	IP20

Da Terra

Floor Lamps



Stem
p.504



Oslo Floor
p.505



Lunar Floor
p.506



Rod Floor
p.508



Soft Floor
p.510



Inge
p.512



Bow
p.514



Shade
p.518



Maiko
p.520



Zaria
p.522



Night
p.524



Loft
p.525

Stem

☐ 220÷240 V SMD Led

Stem è una lampada da terra realizzata in alluminio verniciato. Illumina l'ambiente con luce diffusa grazie al suo schermo diffondente in PMMA. Stem è dotata di sorgente LED ad alta efficienza alimentata da un driver elettronico integrato nell'apparecchio. Il cavo di alimentazione in PVC da 180 cm. di lunghezza è completo di dimmer a pedale.

Stem is a floor lamp made of painted aluminium. It illuminates the room with diffused light thanks to its PMMA diffusing screen. Stem is equipped with a high efficiency LED source powered by an electronic driver integrated in the fixture. The 180 cm PVC power cable. length is complete with footswitch dimmer.

Dimensioni / Dimensions



kg 0,8



Stem

Versione Model	Codice Code	Colore Finishing	Potenza / Flusso Effettivo Power / Lumen Output	CCT CCT	Sorgente Source	Alimentazione Power feeding	Classe energetica Energy Label	IP IP
Floor Lamp	TER00043	Bianco / White	32 W	3000 K	SMD LED	220÷240 V - class II	LED	IP20

Oslo Floor

□ 220÷240V E14

Oslo Floor è una lampada da terra realizzata in alluminio verniciato; è la piantana ideale per la lettura per via della sua altezza ridotta a 150 cm. e per la possibilità di orientarne la testa; questa si orienta ruotando sul suo attacco, mentre lo stelo si inclina ruotando su una apposita cerniera. L'interruttore di accensione on/off è posizionato frontalmente sullo stelo; dotata di attacco lampada E27, emette un fascio di luce concentrato. Si completa di cavo di alimentazione in rivestimento tessile grigio chiaro o nero, lunghezza massima 180 cm.

Oslo Floor is a floor lamp made of painted aluminium; it is the ideal floor lamp for reading thanks to its height reduced to 150 cm. and for the possibility of aim its head; this is adjustable by rotating on its attachment, while the stem tilts by rotating on a special hinge. The on/off switch is positioned frontally on the stem; equipped with E27 lamp socket, Oslo emits a concentrated light beam. It comes complete with power cable in light gray or black textile coating, maximum length 180 cm.

Dimensioni / Dimensions

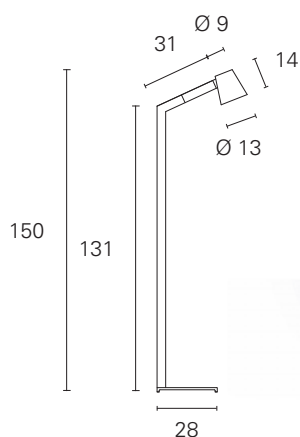

kg 5,8



Oslo Table
pag.529



Oslo Floor

Versione Model	Codice Code	Colore Finishing	Potenza / Flusso Effettivo Power / Lumen Output	CCT CCT	Sorgente Source	Alimentazione Power feeding	Classe energetica Energy Label	IP
Floor Lamp	TER00046	Nero / Black	4 W / 400 lm	2700 K	LED Filament E14	220÷240 V - class II	LED	IP20
Floor Lamp	TER00047	Bianco / White	4 W / 400 lm	2700 K	LED Filament E14	220÷240 V - class II	LED	IP20

Lunar Floor

□ 220÷240 V SMD Led

Lunar Floor è una piantana dimmerabile realizzata in metallo verniciato. Si caratterizza per il suo schermo diffondente PMMA che ruota su sé stesso e permette di illuminare gli ambienti con una luce gradevolmente diffusa. Lunar Floor è dotata di sorgente LED ad alta efficienza e di driver elettronico integrato nell'apparecchio ed è completa di cavo alimentazione in PVC bianco o grigio; il cavo di alimentazione include il dimmer a pedale ed è lungo 180 cm.

Lunar Floor is a dimmable floor lamp made of painted metal. It is characterized by its PMMA diffusing screen that rotates on itself and allows to illuminate the rooms with a pleasantly diffused light. Lunar Floor is equipped with a high efficiency LED source and an electronic driver integrated in the luminaire and is complete with a white or gray PVC power cable; the power cable includes the pedal dimmer and is 180 cm long.



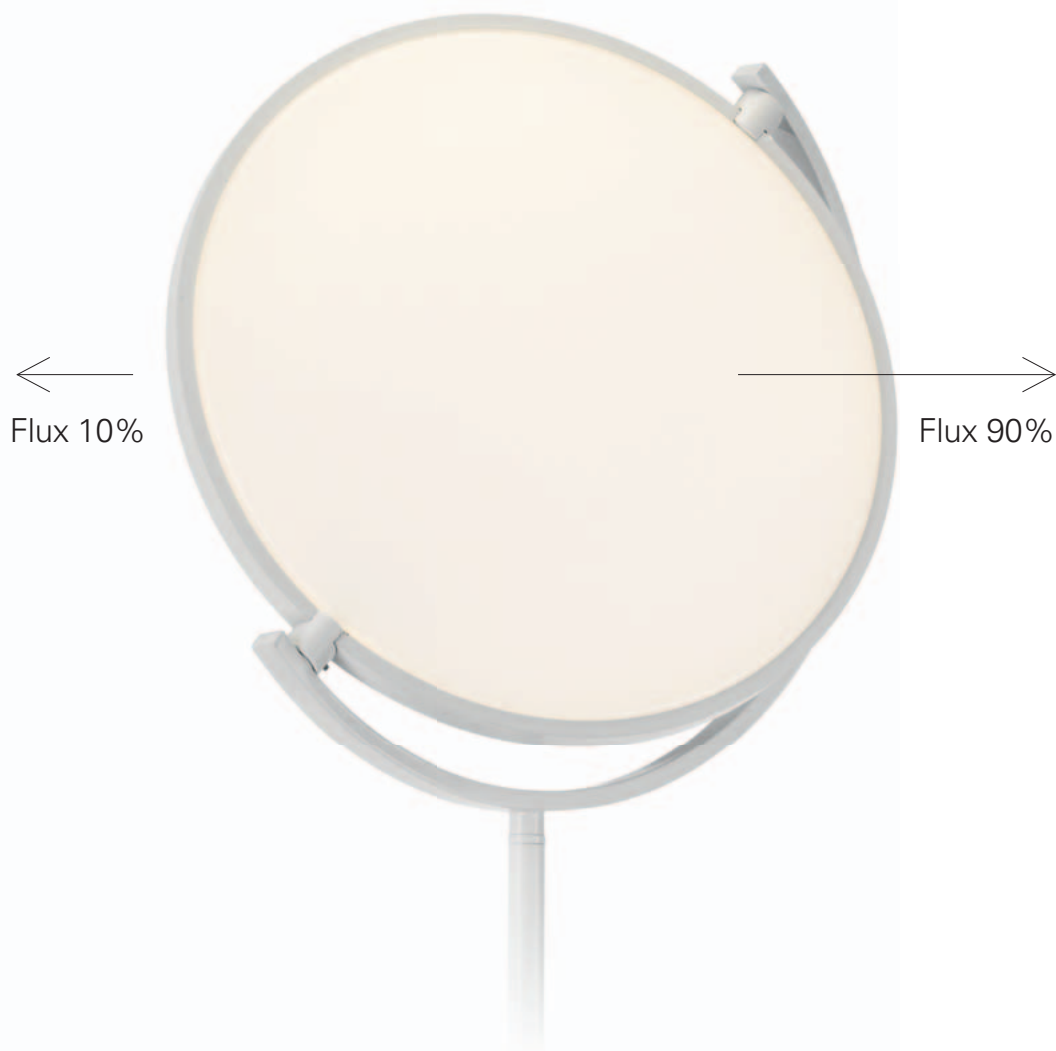

Dimensioni / Dimensions

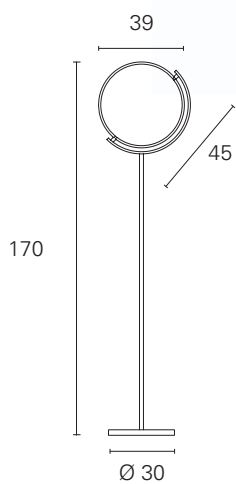

7,7

Ottiche / Optics

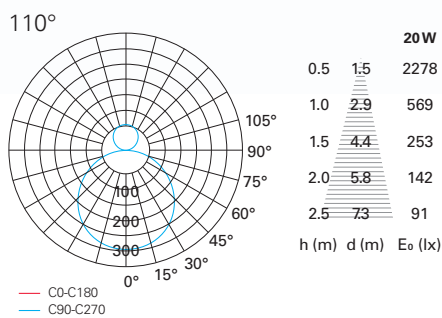

Lunar Pendant
pag.436



Lunar Floor

Versione Model	Codice Code	Colore Finishing	Potenza / Flusso Effettivo Power / Lumen Output	CCT CCT	Sorgente Source	Alimentazione Power feeding	Classe energetica Energy Label	IP
Floor Lamp	TER00039	Nero / Black	20 W / 1910 lm	3000 K	SMD LED	220÷240 V - class II	LED	IP20
Floor Lamp	TER00040	Bianco / White	20 W / 1910 lm	3000 K	SMD LED	220÷240 V - class II	LED	IP20

Flusso luminoso emesso: semi-diretto; frontale 90% retro 10% / Luminous flux output: semi-direct; front 90% back 10%

Rod Floor



□ 220÷240 V E27

Rod Floor è una lampada da terra in coordinato con le versioni Rod pendant. Realizzata in metallo verniciato bianco opaco o nero opaco è completa di attacco lampada E27 che si regola in altezza scorrendo sull'asta e bloccandosi grazie all'apposita ghiera. Si completa di cavo di alimentazione nero e pedale per l'accensione on/off.

Rod Floor is a floor lamp coordinated with the Rod pendant versions. Made of matt white or matt black painted metal, it comes complete with an E27 lamp attachment that adjusts in height by sliding on the stem and locking thanks to the special ring nut. It comes complete with a black power cable and pedal for on/off switching.

Dimensioni / Dimensions

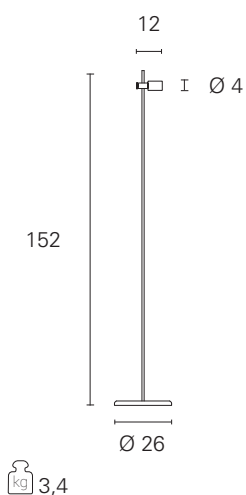

Rod Pendant
pag. 454



Rod Floor

Versione Model	Codice Code	Colore Finishing	Potenza / Flusso Effettivo Power / Lumen Output	CCT CCT	Sorgente Source	Alimentazione Power feeding	Classe energetica Energy Label	IP IP
Floor Lamp	TER00033	Nero / Black	6 W / 450 lm	2700 K	LED Filament E27	220÷240 V - class II	LED	IP20

Soft Floor

□ 220÷240 V E27

Soft Floor è una lampada da terra caratterizzata dalla struttura in metallo cromato. È realizzata in due versioni: dal design classico, con asta dritta e paralume fisso, o con asta completa di doppio braccio snodabile che permette di orientare il paralume in tessuto. Grazie a Soft Floor è possibile ottenere una luce morbida e confortevole, perfettamente diffusa sia sul paralume che nell'ambiente circostante. L'interruttore on/off è posizionato sulla base.

Soft Floor is a floor lamp characterized by the chromed metal structure. It is made in two versions: with a classic design, with straight rod and fixed lampshade, or with rod complete with double articulated arm that allows you to orient the fabric lampshade. Thanks to Soft Floor it is possible to obtain a soft and comfortable light, perfectly diffused both on the lampshade and in the surrounding ambient. The on/off switch is located on the base.





Dimensioni / Dimensions

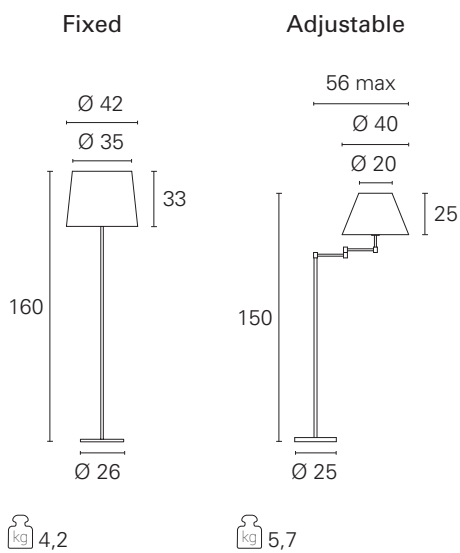

Soft Table
pag. 528



Soft Wall
pag. 596



Soft Floor

Versione Model	Codice Code	Colore Finishing	Potenza / Flusso Effettivo Power / Lumen Output	Sorgente Source	Alimentazione Power feeding	Classe energetica Energy Label	IP IP
Fixed Floor Lamp	TER00027	Cromo - Bianco / Chrome - White	max. 20 W (not included)	LED / FBT E27	220÷240 V - class II	A++...D	IP20
Adjustable Floor Lamp	TER066	Cromo - Bianco / Chrome - White	max. 20 W (not included)	LED / FBT E27	220÷240 V - class II	A++...D	IP20

Inge

□ 220÷240 V E27

Inge è una lampada da terra caratterizzata dalla sua particolare asta, curvata ad arco e realizzata in unico pezzo di metallo verniciato. Si completa con una base in marmo che ne arricchisce il design e al tempo stesso ne assicura la stabilità a terra, e di un paralume in tessuto che diffonde la luce in modo perfettamente uniforme. Completa di attacco E27 si alimenta tramite il cavo in PVC di colore bianco o nero; il cavo di alimentazione è dotato di interruttore a pedale on/off ed è lungo 185 cm.

Inge is a floor lamp characterized by its peculiar stem, arched and made of a single piece of painted metal. It is completed with a marble base that enriches its design and at the same time ensures its stability on the ground, and a fabric lampshade that diffuses the light in a perfectly uniform way. Complete with E27 socket, it is powered by the white or black PVC cable; the power cable is equipped with an on/off footswitch and is 185 cm long.



paralume conico
conical lampshade

Con schermo prismatico accessorio incluso.
With prismatic louvre accessory included.



Bianco Classico
Classic White



Nero Classico
Classic Black

paralume cilindrico
cylindrical lampshade



Lino
Linen



Retinato nero
Black net

Dimensioni / Dimensions

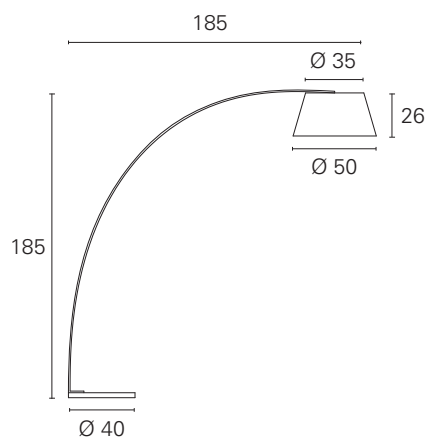

16,0

Inge

Versione <i>Model</i>	Codice <i>Code</i>	Colore <i>Finishing</i>	Potenza / Flusso Effettivo <i>Power / Lumen Output</i>	Sorgente <i>Source</i>	Alimentazione <i>Power feeding</i>	Classe energetica <i>Energy Label</i>	IP <i>IP</i>
Floor Lamp Ø 50 / 35 cm	TER00121	Bianco - Bianco Clas. / White - Clas. White	max. 40 W (not incl.)	LED / IAA E27	220÷240 V - class II	A++...D	IP20
Floor Lamp Ø 50 / 35 cm	TER00120	Nero - Nero Clas. / Black - Clas. Black	max. 40 W (not incl.)	LED / IAA E27	220÷240 V - class II	A++...D	IP20
Floor Lamp Ø 50 / 35 cm	TER00123	Bianco - Lino / White - Linen	max. 40 W (not incl.)	LED / IAA E27	220÷240 V - class II	A++...D	IP20
Floor Lamp Ø 50 / 35 cm	TER00122	Nero - Retinato Nero / Black - Black Net	max. 40 W (not incl.)	LED / IAA E27	220÷240 V - class II	A++...D	IP20

Bow

□ 220÷240 V E27

Bow è una lampada da terra che si distingue per il grande arco; si appoggia a terra grazie alla sua base in metallo assicurandone la stabilità e aggetta un paralume in tessuto che diffonde la luce in modo perfettamente uniforme nell'ambiente. Particolarmente indicata per arredare grandi spazi domestici, è completa di attacco E27 si alimenta tramite il cavo in PVC dotato di interruttore a pedale on/off.

Bow is a floor lamp that stands out for its large arch; equipped with metal base and projecting fabric lampshade that diffuses the light perfectly evenly into the environment. Particularly suitable for furnishing large domestic spaces, it is complete with E27 socket and is powered by the PVC cable equipped with an on/off footswitch.

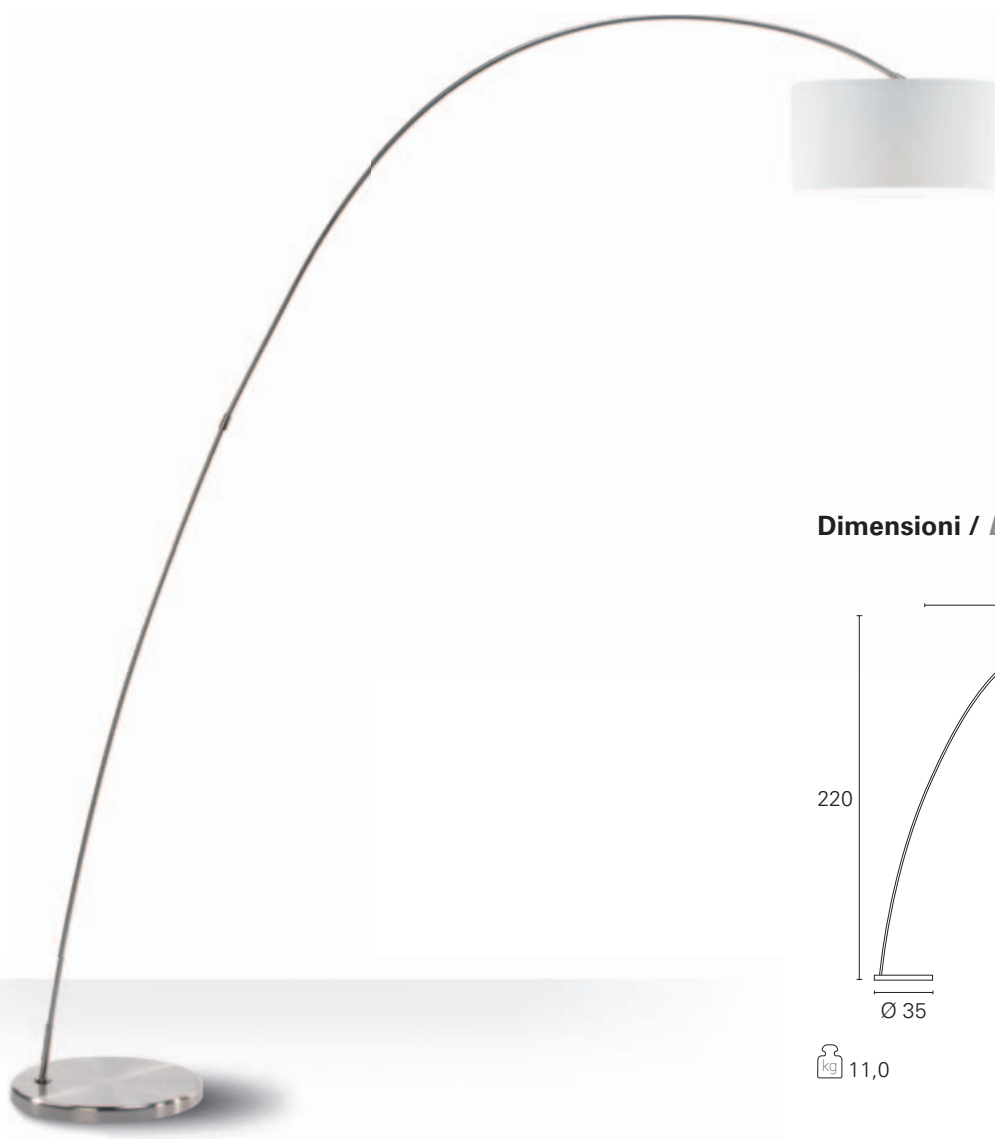

Bow

Versione Model	Codice Code	Colore Finishing	Potenza / Flusso Effettivo Power / Lumen Output	Sorgente Source	Alimentazione Power feeding	Classe energetica Energy Label	IP IP
Floor Lamp	TER095	Acciaio - Bianco / Steel - White	max. 25 W (not included)	LED / FBT E27	220÷240 V - class II	A++...D	IP20



Shade

□ 220÷240 V E27

Shade è una lampada da terra che si caratterizza per la possibilità di regolare l'altezza del paralume; questo scorre lungo l'asta e si blocca grazie ad una ghiera posta dietro l'asta stessa. Il paralume è disponibile in diverse finiture ed è realizzato o in tessuto o in ecopelle. L'asta e la base sono realizzate in legno naturale. Completa di attacco E27, Shade è la piantana ideale per effetti di luce diffusa. Completa di cavo di alimentazione rivestito in tessuto retinato marrone e bianco, di lunghezza massima 200 cm. e dotato di interruttore a pedale on/off.

Shade is a floor lamp which is characterized by the possibility of adjusting the height of the lampshade; this slides along the rod and locks thanks to a ring placed on the rod itself. The lampshade is available in different finishes and is made of either fabric or eco-leather. The rod and base are made of natural wood. Complete with E27 fitting, Shade is the ideal floor lamp for diffused light effects. Complete with power cable covered in brown and white mesh fabric, maximum length 200 cm. and equipped with on/off foot switch.





Shade



Colore / Finishing

paralume cilindrico
cylindrical lampshade



Lino
Linen



Bordeaux
Bordeaux



Grigio - Arancio
Grey - Orange

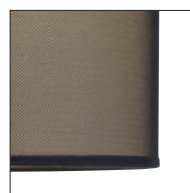

Retinato Nero
Black Net



Pelle
Leather

Dimensioni / Dimensions

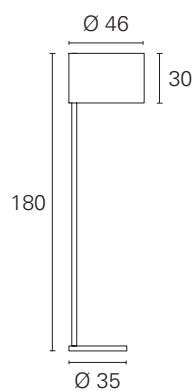

 8,0

Shade

Versione Model	Codice Code	Colore Finishing	Potenza / Flusso Effettivo Power / Lumen Output	Sorgente Source	Alimentazione Power feeding	Classe energetica Energy Label	IP IP
Floor Lamp Ø 46 cm	TER40001	Legno - Lino / Wood - Linen	max. 25 W (not incl.)	LED / FBT E27	220÷240 V - class II	A++...D	IP20
Floor Lamp Ø 46 cm	TER40002	Legno - Bordeaux / Wood - Bordeaux	max. 25 W (not incl.)	LED / FBT E27	220÷240 V - class II	A++...D	IP20
Floor Lamp Ø 46 cm	TER40003	Legno - Grigio Arancio / Wood - Grey Orange	max. 25 W (not incl.)	LED / FBT E27	220÷240 V - class II	A++...D	IP20
Floor Lamp Ø 46 cm	TER40004	Legno - Retinato Nero / Wood - Black Net	max. 25 W (not incl.)	LED / FBT E27	220÷240 V - class II	A++...D	IP20
Floor Lamp Ø 46 cm	TER40005	Legno - Pelle / Wood - Leather	max. 25 W (not incl.)	LED / FBT E27	220÷240 V - class II	A++...D	IP20

Maiko

☐ 220÷240 V E27

Maiko è una lampada da terra completa di paralume in tessuto o in ecopelle. La struttura è realizzata in legno naturale. È completa di attacco E27 e permette di illuminare gli ambienti con una luce morbidamente diffusa. Il cavo di alimentazione è rivestito in tessuto retinato di colore marrone e bianco, lunghezza massima 200 cm. ed è completo di interruttore a pedale on/off.

Maiko is a floor lamp complete with lampshade in fabric or eco-leather. The structure is made of natural wood. It is complete with E27 fitting and allows you to illuminate rooms with softly diffused light. The power cable is covered in brown and white mesh fabric, maximum length 200 cm. and is complete with on/off footswitch.

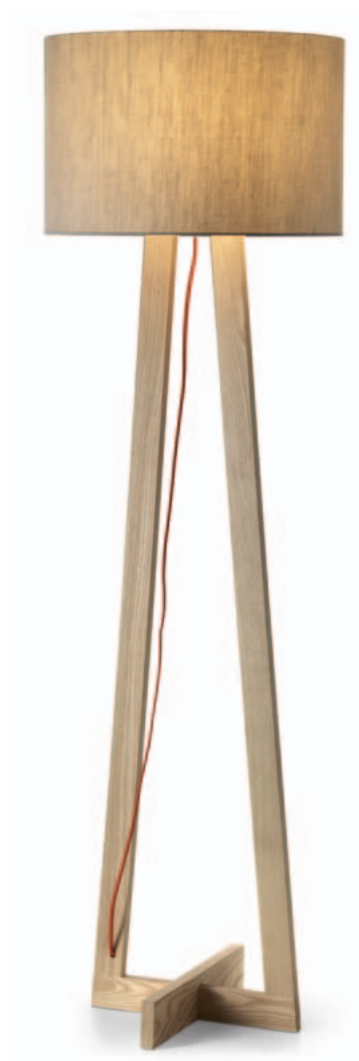

Colore / Finishing

paralume conico
conical lampshade



Bianco Classico
Classic White

paralume cilindrico
cylindrical lampshade



Lino
Linen



Bordeaux
Bordeaux



Grigio - Arancio
Grey - Orange

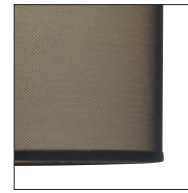

Retinato Nero
Black Net

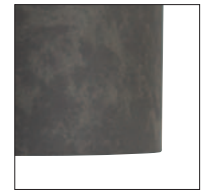

Pelle
Leather

Dimensioni / Dimensions

paralume conico
conical lampshade

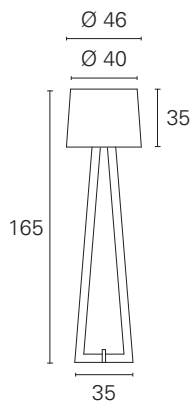

kg 6

paralume cilindrico
cylindrical lampshade

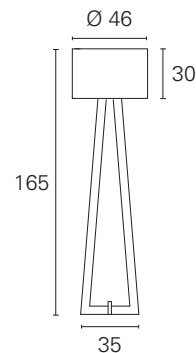

kg 6

Maiko

Versione Model	Codice Code	Colore Finishing	Potenza / Flusso Effettivo Power / Lumen Output	Sorgente Source	Alimentazione Power feeding	Classe energetica Energy Label	IP IP
Floor Lamp Ø 46 cm	TER067	Bianco Classico / Classic White	max. 25 W (not included)	LED / FBT E27	220÷240 V - class II	A++...D	IP20
Floor Lamp Ø 46 cm	TER40010	Legno - Lino / Wood - Linen	max. 25 W (not included)	LED / FBT E27	220÷240 V - class II	A++...D	IP20
Floor Lamp Ø 46 cm	TER40011	Legno - Bordeaux / Wood - Bordeaux	max. 25 W (not included)	LED / FBT E27	220÷240 V - class II	A++...D	IP20
Floor Lamp Ø 46 cm	TER40012	Legno - Grigio Arancio / Wood - Grey Orange	max. 25 W (not included)	LED / FBT E27	220÷240 V - class II	A++...D	IP20
Floor Lamp Ø 46 cm	TER40013	Legno - Retinato Nero / Wood - Black Net	max. 25 W (not included)	LED / FBT E27	220÷240 V - class II	A++...D	IP20
Floor Lamp Ø 46 cm	TER40014	Legno - Pelle / Wood - Leather	max. 25 W (not included)	LED / FBT E27	220÷240 V - class II	A++...D	IP20

Zaria

☐ 220÷240V E27

Zaria è una lampada da terra completa di paralume in tessuto o in ecopelle. La sua struttura è realizzata in legno e si caratterizza per la particolare struttura a tripode. È completa di attacco E27 e permette di illuminare gli ambienti con una luce morbidamente diffusa. Il cavo di alimentazione è rivestito in tessuto retinato di colore marrone e bianco, lunghezza massima 200 cm. ed è completo di interruttore a pedale on/off.

Maiko is a floor lamp complete with lampshade in fabric or eco-leather. Its structure is made of wood and is characterized by the peculiar tripod system. It is complete with E27 fitting and allows you to illuminate rooms with softly diffused light. The power cable is covered in brown and white mesh fabric, maximum length 200 cm. and is complete with on/off footswitch.



Colore / Finishing

paralume conico
conical lampshade



Bianco Classico
Classic White

paralume cilindrico
cylindrical lampshade



Lino
Linen



Bordeaux
Bordeaux



Grigio - Arancio
Grey - Orange



Retinato Nero
Black Net

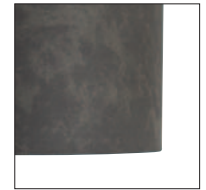

Pelle
Leather

Dimensioni / Dimensions

paralume conico
conical lampshade

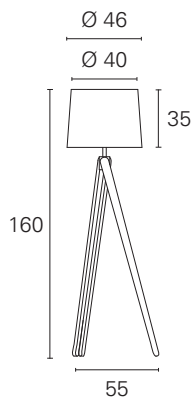

paralume cilindrico
cylindrical lampshade

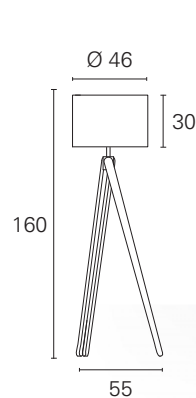

5,2



Zaria

Versione Model	Codice Code	Colore Finishing	Potenza / Flusso Effettivo Power / Lumen Output	Sorgente Source	Alimentazione Power feeding	Classe energetica Energy Label	IP
Floor Lamp Ø 46 cm	TER068	Bianco Classico / Classic White	max. 25 W (not included)	LED / IAA E27	220÷240 V - class II	A++...D	IP20
Floor Lamp Ø 46 cm	TER40020	Legno - Lino / Wood - Linen	max. 25 W (not included)	LED / IAA E27	220÷240 V - class II	A++...D	IP20
Floor Lamp Ø 46 cm	TER40021	Legno - Bordeaux / Wood - Bordeaux	max. 25 W (not included)	LED / IAA E27	220÷240 V - class II	A++...D	IP20
Floor Lamp Ø 46 cm	TER40022	Legno - Grigio Arancio / Wood - Grey Orange	max. 25 W (not included)	LED / IAA E27	220÷240 V - class II	A++...D	IP20
Floor Lamp Ø 46 cm	TER40023	Legno - Retinato Nero / Wood - Black Net	max. 25 W (not included)	LED / IAA E27	220÷240 V - class II	A++...D	IP20
Floor Lamp Ø 46 cm	TER40024	Legno - Pelle / Wood - Leather	max. 25 W (not included)	LED / IAA E27	220÷240 V - class II	A++...D	IP20

Night

□ 220÷240 V E27

Night è una lampada da terra realizzata con un'asta di metallo e diffusore a gondola in vetro satinato. È completa di attacco E27 ed illumina con luce diffusa verso l'alto l'ambiente. Il cavo di alimentazione in PVC trasparente è completo di interruttore a pedale on/off.

Night is a floor lamp made with a metal rod and gondola diffuser in satin glass. It is complete with E27 fitting and illuminates the room with diffused light upwards. The transparent PVC power cable is complete with on / off foot switch.



Dimensioni / Dimensions

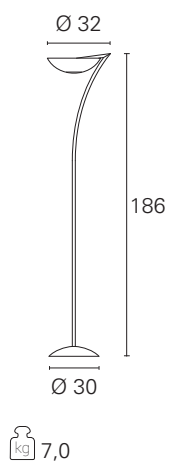

Night

Versione Model	Codice Code	Colore Finishing	Potenza / Flusso Effettivo Power / Lumen Output	Sorgente Source	Alimentazione Power feeding	Classe energetica Energy Label	IP IP
Floor Lamp	PFA726	Acciaio / Steel	max. 60 W (not included)	LED / IAA E27	220÷240 V - class II	A++...D	IP20

Loft

⊕ 220÷240 V SMD Led

Loft è una lampada da terra particolarmente indicata per l'illuminazione indiretta dell'ambiente e per luce da lettura. Quest'ultima è data dalla sorgente led posizionata sulla testa più piccola, orientabile grazie ad un braccetto flessibile, accendibile separatamente. La struttura è realizzata in metallo e si completa con un diffusore in vetro. Loft è equipaggiata con attacco E27 o equivalenti a LED e cavo di alimentazione in PVC trasparente di lunghezza massima 180 cm.

Loft is a floor lamp particularly suitable for indirect ambient lighting and for reading light. The latter is given by the LED source positioned on the smaller head, adjustable thanks to a flexible arm, which can be switched on separately. The structure is made of metal and is completed with a glass diffuser. Loft is equipped with E27 socket or LED equivalents and a transparent PVC power cable with a maximum length of 180 cm.



Dimensioni / Dimensions

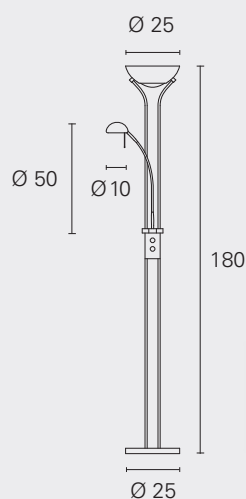

kg 6,0

Loft

Versione Model	Codice Code	Colore Finishing	Potenza / Flusso Effettivo Power / Lumen Output	CCT CCT	Sorgente Source	Alimentazione Power feeding	Classe energetica Energy Label	IP IP
Floor Lamp	TER00005	Acciaio / Steel	20 W+4 W / 2200 lm	3000 K	SMD LED	220÷240 V - class I	LED	IP20

Da Tavolo

Table Lamps



Soft Table
p.528



Oslo Table
p.529



Mikka
p.530



Milla
p.532



Urban Table
p.534



Yab
p.536



Alter
p.538



Summer
p.540



Mida
p.541

Soft Table

☐ 220÷240 V E27

Soft Table è una lampada da tavolo che si abbina in coordinato alle piantane Soft Floor e alla versione da parete Soft Wall. Con astina fissa in metallo, è completa di paralume in tessuto che fornisce un'illuminazione morbida e diffusa. Dotata di attacco E27 si alimenta grazie al cavo PVC trasparente, di lunghezza 180 cm. sul quale si trova l'interruttore on/off.

Soft Table is a table lamp that matches with the Soft Floor and the Soft Wall mounted version. With fixed metal rod, it is complete with fabric lampshade that provides soft and diffused lighting. Equipped with E27 connection, it is powered by the transparent PVC cable, 180 cm long. on which the on/off switch is located.



Dimensioni / Dimensions

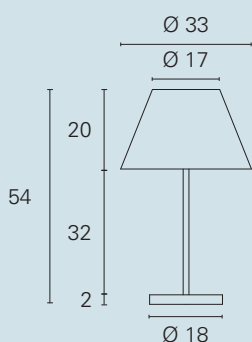

kg 2,0

Soft Floor
pag. 510



Soft Wall
pag. 496



Soft Table

Versione Model	Codice Code	Colore Finishing	Potenza / Flusso Effettivo Power / Lumen Output	Sorgente Source	Alimentazione Power feeding	Classe energetica Energy Label	IP IP
Table Lamp	TAV564	Cromo - Bianco / Chrome - White	max. 15 W (not included)	LED / FBT E27	220÷240 V - class II	A++...D	IP20

Oslo Table

□ 220÷240 V E14

Lampada da tavolo. Corpo in alluminio verniciato. Interruttore di accensione sullo stelo. Per lampade con attacco E27 o equivalenti a LED. Per effetti di luce concentrata. Braccio e testa orientabili. Cavo di alimentazione in rivestimento tessile grigio chiaro o nero, lunghezza massima 180 cm. Interruttore ON/OFF sullo stelo.

Table lamp. Painted aluminium body. ON/OFF on the stem. For E27 light bulb or LED equivalent. For concentrated light effect. Adjustable arm and head. Light grey or black fabric power cord, maximum length 180 cm. ON/OFF on the stem.



Dimensioni / Dimensions

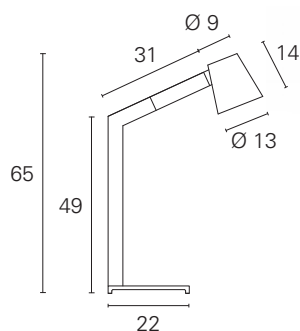

kg 3,3

Oslo Floor
pag. 505



Oslo Table

Versione Model	Codice Code	Colore Finishing	Potenza / Flusso Effettivo Power / Lumen Output	CCT CCT	Sorgente Source	Alimentazione Power feeding	Classe energetica Energy Label	IP IP
Table Lamp	TAV00071	Nero / Black	4 W / 400 lm	2700 K	LED Filament E14	220÷240 V - class II	LED	IP20
Table Lamp	TAV00072	Bianco / White	4 W / 400 lm	2700 K	LED Filament E14	220÷240 V - class II	LED	IP20

Mikka



□ 220÷240 V SMD Led

Mikka è una lampada da tavolo realizzata in alluminio verniciato bianco opaco o nero opaco che illumina in modo estremamente gradevole l'ambiente grazie alla sua luce morbida e diffusa. Mikka è dimmerabile e dotata di touch dimmer posizionato direttamente sul corpo del prodotto per un'agevole regolazione della luce. Completa di schermo diffondente in PMMA e di sorgente LED ad alta efficienza, include il driver elettronico integrato nell'apparecchio. La sua sorgente luminosa è totalmente schermata alla vista per evitare qualsiasi forma di abbagliamento. Il cavo di alimentazione di lunghezza 160 cm è in colore bianco o nero in tinta con il corpo.

Mikka is a table lamp made of matt white or matt black painted aluminium that illuminates the ambient in an extremely pleasant way thanks to its softly diffused light. Mikka is dimmable and equipped with a touch dimmer positioned on the product body for easy light adjustment. Complete with PMMA diffusing screen and high efficiency LED source, it includes the electronic driver integrated in the luminaire. Its light source is totally shielded from view to avoid any form of glare. The 160 cm long power cable is in white or black to match the body.



Dimensioni / Dimensions

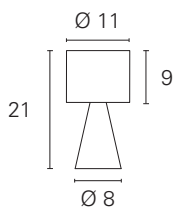

kg 1,3

	Luminous intensity
1	low level
2	medium level
3	high level
4	off



Mikka

Versione Model	Codice Code	Colore Finishing	Potenza / Flusso Effettivo Power / Lumen Output	CCT CCT	Sorgente Source	Alimentazione Power feeding	Classe energetica Energy Label	IP IP
Table Lamp	TAV40000	Nero / Black	8,4 W / 460 lm	3000 K	SMD LED	220÷240 V - class II	LED	IP20
Table Lamp	TAV40001	Bianco / White	8,4 W / 460 lm	3000 K	SMD LED	220÷240 V - class II	LED	IP20

Milla

□ 220÷240 V SMD Led

Milla è una lampada da tavolo dimmerabile realizzata in alluminio verniciato. Il particolare stelo include la sorgente di luce a led, che è completamente nascosta alla vista per evitare qualsiasi forma di abbagliamento diretto. La sorgente LED ad alta efficienza è integrata nell'apparecchio così come il driver elettronico. La sua accensione e regolazione avviene dal pulsante tipo "soft touch" posizionato sulla base. Cavo di alimentazione in piattina in silicone di colore bianco di 200 cm. di lunghezza.

Milla is a dimmable table lamp made of painted aluminium. The particular stem includes the LED light source, which is completely hidden from view to avoid any form of direct glare. The high efficiency LED source is integrated into the fixture as well as the electronic driver. Its switching on/off and dimming is made by a "soft touch" button located on the base. White silicone flat power cord, maximum length 200 cm.

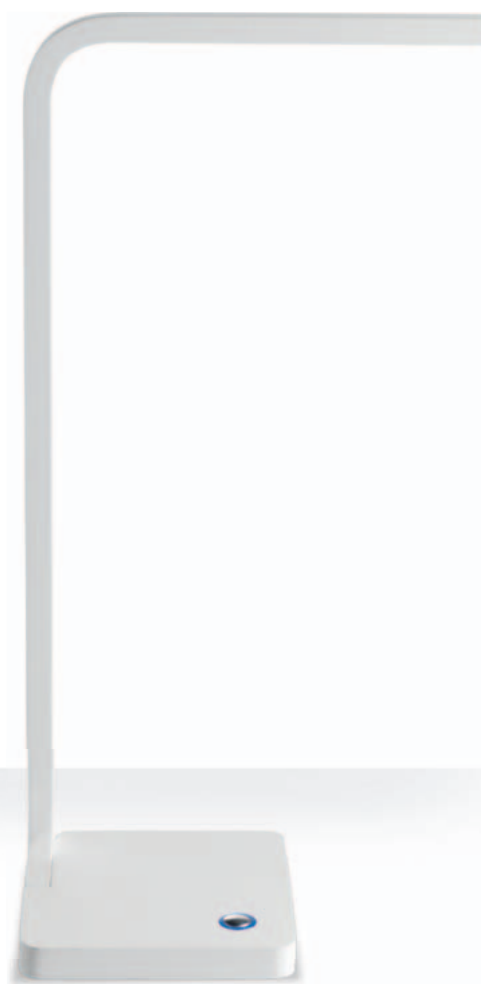

Dimensioni / Dimensions

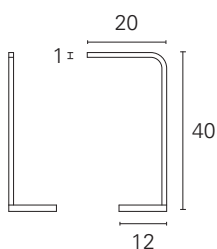

kg 0,7

	Luminous intensity
1	low level
2	medium level
3	high level
4	off





Milla

Versione <i>Model</i>	Codice <i>Code</i>	Colore <i>Finishing</i>	Potenza / Flusso Effettivo <i>Power / Lumen Output</i>	CCT <i>CCT</i>	Sorgente <i>Source</i>	Alimentazione <i>Power feeding</i>	Classe energetica <i>Energy Label</i>	IP <i>IP</i>
Table Lamp	TAV00040	Bianco / White	5 W / 340 lm	3000 K	SMD LED	220÷240 V - class II	LED	IP20

Urban Table



□ 220÷240 V E27

Urban è una lampada da tavolo realizzata in cemento liscio. La maniglia in pelle permette una presa sicura per gli eventuali spostamenti e ne caratterizza l'aspetto estetico contrapponendo materiali diversi. Completa di lampada con attacco E27 è dotata di cavo di alimentazione in rivestimento tessile di colore nero, lungo 160 cm. e di interruttore On/Off posizionato sul cavo di alimentazione.

Urban is a table lamp made of smoothed concrete. The leather handle allows a secure grip for any movement and characterizes its aesthetic appearance by contrasting different materials. Complete with lamp with E27 socket, it is equipped with a power cable in black textile coating, 160 cm long. and on/off switch located on the power cable.

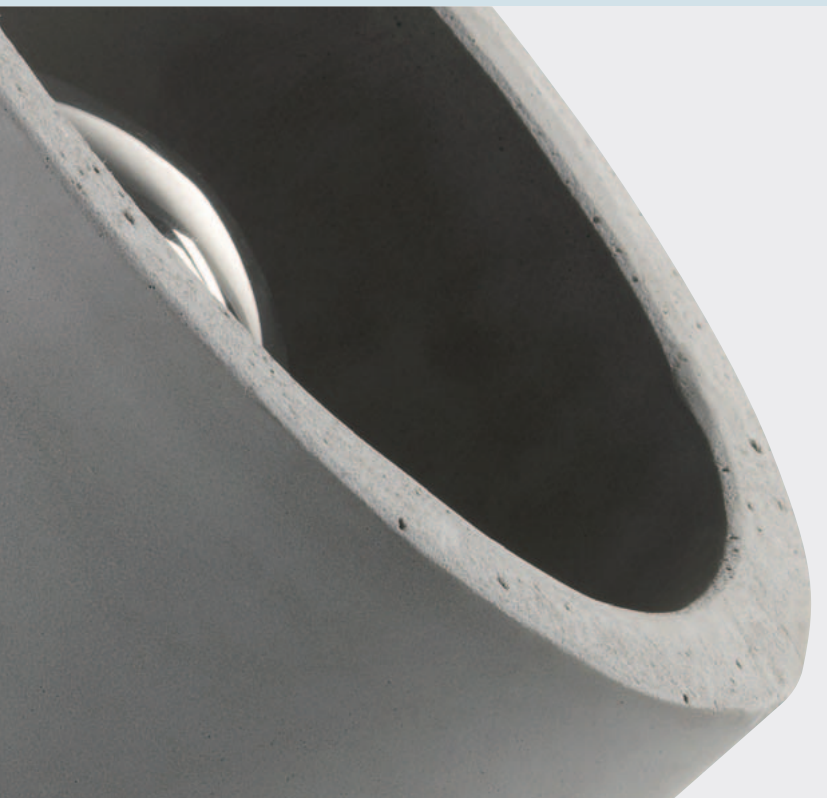

Cemento
Cement

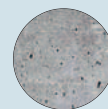

Dimensioni / Dimensions

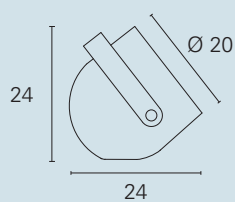

 4,0

Urban Pendant
pag. 442



Urban Table

Versione Model	Codice Code	Colore Finishing	Potenza / Flusso Effettivo Power / Lumen Output	CCT CCT	Sorgente Source	Alimentazione Power feeding	Classe energetica Energy Label	IP IP
Table Lamp	TAV48000	Grigio - Nero / Grey - Black	4 W / 400 lm	2700 K	LED Filament E27	220÷240 V - class II	LED	IP20

Yab

Touch



□ 220÷240 V SMD Led

Yab è una lampada da tavolo "a pantografo" realizzata in alluminio verniciato progettata per l'illuminazione diretta per la scrivania. L'interruttore di accensione sulla testa dell'apparecchio di tipo "soft touch" consente l'accensione e la dimmerazione con una leggera pressione del dito; la sua struttura è caratterizzata dal braccio regolabile bilanciato e dalla testa ottica orientabile. La sorgente LED ad alta efficienza è alimentata dal driver elettronico integrato nell'apparecchio. Cavo di alimentazione in piattina in silicone di colore bianco, lunghezza 200 cm.

Yab is a "pantograph" table lamp made of painted aluminium designed for direct lighting for the desk. The "soft touch" type on / off switch on the head of the appliance allows it to be switched on and dimmed with a light finger pressure; its structure is characterized by the balanced adjustable arm and the adjustable optical head. The high efficiency LED source is powered by the electronic driver integrated in the fixture. White silicone flat power cord, maximum length 200 cm.



Dimensioni / Dimensions

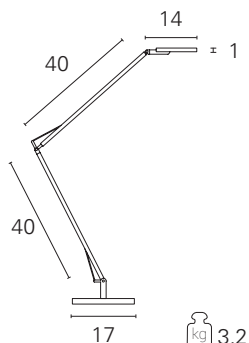

	Luminous intensity
1	last level setting
2 +	push
3 -	push
4	off



Yab

Versione Model	Codice Code	Colore Finishing	Potenza / Flusso Effettivo Power / Lumen Output	CCT CCT	Sorgente Source	Alimentazione Power feeding	Classe energetica Energy Label	IP IP
Adjustable Desk Light	TAV00068	Bianco / White	8 W / 450 lm	3000 K	SMD LED	220÷240 V - class II	LED	IP20

Alter

☐ 220÷240 V CoB Led

Alter è una lampada da tavolo "a pantografo" realizzata in metallo verniciato. Il suo braccio regolabile è bilanciato dalla testa ottica orientabile. Alter illumina la scrivania grazie a un CoB Led alimentato da un driver integrato. Si completa con un cavo di alimentazione in silicone nero di 150 cm. ed un interruttore on/off posizionato sotto la testa del corpo lampada.

Alter is a "pantograph" table lamp made of painted metal. Its adjustable arm is balanced by the adjustable optical head. Alter lights the desk thanks to a CoB Led powered by an integrated driver. It is completed with a 150 cm black silicone power cable. and an on/off switch located under the head of the lamp body.





Dimensioni / Dimensions

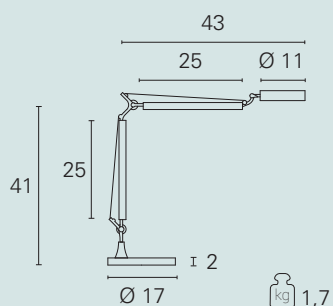

Alter

Versione Model	Codice Code	Colore Finishing	Potenza / Flusso Effettivo Power / Lumen Output	CCT CCT	Sorgente Source	Alimentazione Power feeding	Classe energetica Energy Label	IP IP
Adjustable Desk Light	TAV00004	Nero / Black	5 W / 410 lm	4000 K	CoB LED	220÷240 V - class II	LED	IP20
Adjustable Desk Light	TAV00005	Cromo / Chrome	5 W / 410 m	4000 K	CoB LED	220÷240 V - class II	LED	IP20

Summer

□ 220÷240 V E27

Con la sua struttura "a pantografo", Summer è una lampada da tavolo realizzata in metallo cromato e caratterizzata dalla testa semitrasparente. Il suo braccio regolabile è bilanciato dalla testa ottica orientabile. Summer è dotata di attacco E27 e si completa con un cavo di alimentazione di 150 cm. e con un interruttore on/off posizionato dietro la testa.

With its "pantograph" structure, Summer is a table lamp made of chrome metal and characterized by a semi-transparent head. Its adjustable arm is balanced by the adjustable optical head. Summer is equipped with an E27 connection and is completed with a 150 cm power cable and with an on/off switch positioned behind the head.



Dimensioni / Dimensions

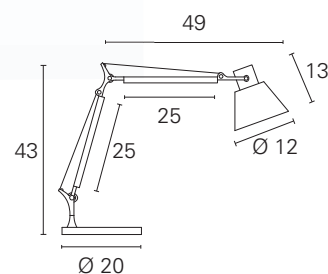

kg 1,7

Summer

Versione Model	Codice Code	Colore Finishing	Potenza / Flusso Effettivo Power / Lumen Output	Sorgente Source	Alimentazione Power feeding	Classe energetica Energy Label	IP IP
Adjustable Desk Light	TAV378	Cromo / Chrome	max. 15 W (not included)	LED / FBT E27	220÷240 V - class II	A++...D	IP20

Mida

□ 220÷240 V E27

Mida è una lampada da tavolo "a pantografo" realizzata in metallo verniciato e completa di testa orientabile a ogiva. Il suo braccio regolabile è bilanciato dalla testa ottica. Mida è dotata di attacco E27 e si completa con un cavo di alimentazione di 150 cm. e con un interruttore on/off posizionato dietro la testa.

Mida is a "pantograph" table lamp made of painted metal and complete with an adjustable ogive head. Its adjustable arm is balanced by the optical head. Mida has an E27 connection and is completed with a 150 cm power cable and with an on/off switch positioned behind the head.



Dimensioni / Dimensions

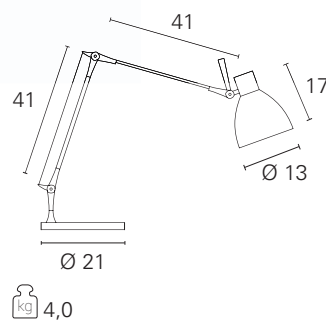

Mida

Versione Model	Codice Code	Colore Finishing	Potenza / Flusso Effettivo Power / Lumen Output	Sorgente Source	Alimentazione Power feeding	Classe energetica Energy Label	IP IP
Adjustable Desk Light	TAV423	Cromo - Alluminio / Chrome - Aluminum	max. 40 W (not included)	LED / IAA E27	220÷240 V - class II	A++...D	IP20

Drivers e Controlli

Drivers and Controllers

Drivers	544
Emergency Kits	546
Control Systems	548

Corrente Costante IP20 / Costant Current IP20

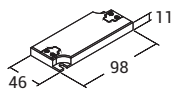

controllo <i>control</i>	on-off
corrente in uscita <i>output current</i>	350 mA
codice <i>code</i>	DRV1008
potenza <i>power</i>	max 6 W
tensione in uscita <i>output voltage</i>	2 ÷ 18V DC
tensione in ingr. <i>voltage range</i>	220÷240 V - 50 / 60 Hz
cl. isolamento / IP <i>insulation class / IP</i>	class II / IP20
peso <i>weight</i>	0,04 kg

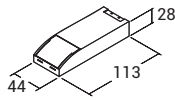

controllo <i>control</i>	on-off
corrente in uscita <i>output current</i>	350 mA
codice <i>code</i>	DRV1004
potenza <i>power</i>	max 12 W
tensione in uscita <i>output voltage</i>	2 ÷ 32V DC
tensione in ingr. <i>voltage range</i>	220÷240 V - 50 / 60 Hz
cl. isolamento / IP <i>insulation class / IP</i>	class II / IP20
peso <i>weight</i>	0,06 kg

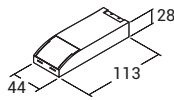

controllo <i>control</i>	Phase cut IGBT / TRIAC
corrente in uscita <i>output current</i>	350 mA
codice <i>code</i>	DRV1006
potenza <i>power</i>	max 18 W
tensione in uscita <i>output voltage</i>	15 ÷ 52V DC
tensione in ingr. <i>voltage range</i>	220÷240 V - 50 / 60 Hz
cl. isolamento / IP <i>insulation class / IP</i>	class II / IP20
peso <i>weight</i>	0,10 kg

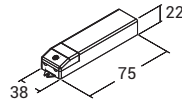

controllo <i>control</i>	on-off
corrente in uscita <i>output current</i>	500 mA
codice <i>code</i>	DRV1020
potenza <i>power</i>	max 8 W
tensione in uscita <i>output voltage</i>	3 ÷ 15V DC
tensione in ingr. <i>voltage range</i>	220÷240 V - 50 / 60 Hz
cl. isolamento / IP <i>insulation class / IP</i>	class II / IP20
peso <i>weight</i>	0,05 kg

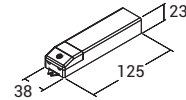

controllo <i>control</i>	on-off
corrente in uscita <i>output current</i>	500 mA
codice <i>code</i>	DRV1021
potenza <i>power</i>	max 16,8 W
tensione in uscita <i>output voltage</i>	3 ÷ 33V DC
tensione in ingr. <i>voltage range</i>	220÷240 V - 50 / 60 Hz
cl. isolamento / IP <i>insulation class / IP</i>	class II / IP20
peso <i>weight</i>	0,08 kg

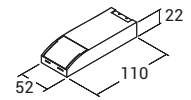

controllo <i>control</i>	Phase cut IGBT / TRIAC
corrente in uscita <i>output current</i>	700 mA
codice <i>code</i>	DRV1035
potenza <i>power</i>	max 20 W
tensione in uscita <i>output voltage</i>	5 ÷ 29V DC
tensione in ingr. <i>voltage range</i>	220÷240 V - 50 / 60 Hz
cl. isolamento / IP <i>insulation class / IP</i>	class II / IP20
peso <i>weight</i>	0,10 kg

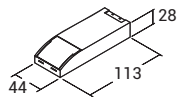

controllo <i>control</i>	on-off
potenza <i>power</i>	700 mA
codice <i>code</i>	DRV1005
corrente in uscita <i>output current</i>	max 20 W
tensione in uscita <i>output voltage</i>	2 ÷ 29V DC
tensione in ingr. <i>voltage range</i>	220÷240 V - 50 / 60 Hz
cl. isolamento / IP <i>insulation class / IP</i>	class II / IP20
peso <i>weight</i>	0,09 kg

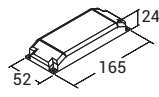

controllo <i>control</i>	Phase cut IGBT / TRIAC
potenza <i>power</i>	700 mA
codice <i>code</i>	DRV1013
corrente in uscita <i>output current</i>	max 36 W
tensione in uscita <i>output voltage</i>	24 ÷ 52V DC
tensione in ingr. <i>voltage range</i>	220÷240 V - 50 / 60 Hz
cl. isolamento / IP <i>insulation class / IP</i>	class II / IP20
peso <i>weight</i>	0,21 kg

Corrente Costante IP67 / Costant Current IP67

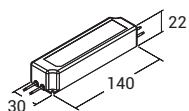

controllo <i>control</i>	on-off
corrente in uscita <i>output current</i>	350 mA
codice <i>code</i>	DRV1050
potenza <i>power</i>	max 16,8 W
tensione in uscita <i>output voltage</i>	6 ÷ 48V DC
tensione in ingr. <i>voltage range</i>	220÷240 V - 50 / 60 Hz
cl. isolamento / IP <i>insulation class / IP</i>	class II / IP67
peso <i>weight</i>	0,17 kg

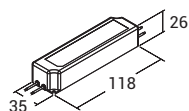

controllo <i>control</i>	on-off
corrente in uscita <i>output current</i>	500 mA
codice <i>code</i>	DRV1023
potenza <i>power</i>	max 17,5 W
tensione in uscita <i>output voltage</i>	9 ÷ 35V DC
tensione in ingr. <i>voltage range</i>	220÷240 V - 50 / 60 Hz
cl. isolamento / IP <i>insulation class / IP</i>	class II / IP67
peso <i>weight</i>	0,17 kg

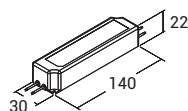

controllo <i>control</i>	on-off
corrente in uscita <i>output current</i>	700 mA
codice <i>code</i>	DRV1060
potenza <i>power</i>	max 17,5 W
tensione in uscita <i>output voltage</i>	6 ÷ 25V DC
tensione in ingr. <i>voltage range</i>	220÷240 V - 50 / 60 Hz
cl. isolamento / IP <i>insulation class / IP</i>	class II / IP67
peso <i>weight</i>	0,17 kg

Tensione Costante IP20 / *Costant Voltage IP20*

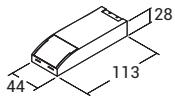

controllo <i>control</i>	on-off
tensione in uscita <i>output voltage</i>	12V DC
codice <i>code</i>	DRV2000
corrente in uscita <i>output current</i>	0 ÷ 1,7 A
potenza <i>power</i>	max 20 W
tensione in ingr. <i>voltage range</i>	220÷240 V - 50 / 60 Hz
cl. isolamento / IP <i>insulation class / IP</i>	class II / IP20
peso <i>weight</i>	0,09 kg

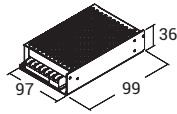

controllo <i>control</i>	on-off
tensione in uscita <i>output voltage</i>	12V DC
codice <i>code</i>	DRV2004
corrente in uscita <i>output current</i>	0 ÷ 4,2 A
potenza <i>power</i>	max 50 W
tensione in ingr. <i>voltage range</i>	220÷240 V - 50 / 60 Hz
cl. isolamento / IP <i>insulation class / IP</i>	class I / IP\
peso <i>weight</i>	0,25 kg

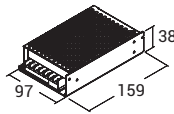

controllo <i>control</i>	on-off
tensione in uscita <i>output voltage</i>	12V DC
codice <i>code</i>	DRV2006
corrente in uscita <i>output current</i>	0 ÷ 8,5 A
potenza <i>power</i>	max 100 W
tensione in ingr. <i>voltage range</i>	220÷240 V - 50 / 60 Hz
cl. isolamento / IP <i>insulation class / IP</i>	class I / IP\
peso <i>weight</i>	0,56 kg

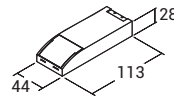

controllo <i>control</i>	on-off
tensione in uscita <i>output voltage</i>	24V DC
codice <i>code</i>	DRV2001
corrente in uscita <i>output current</i>	0 ÷ 0,83 A
potenza <i>power</i>	max 20 W
tensione in ingr. <i>voltage range</i>	220÷240 V - 50 / 60 Hz
cl. isolamento / IP <i>insulation class / IP</i>	class II / IP20
peso <i>weight</i>	0,09 kg

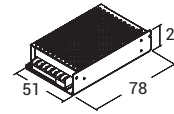

controllo <i>control</i>	on-off
tensione in uscita <i>output voltage</i>	24V DC
codice <i>code</i>	DRV2005
corrente in uscita <i>output current</i>	0 ÷ 2,2 A
potenza <i>power</i>	max 50 W
tensione in ingr. <i>voltage range</i>	220÷240 V - 50 / 60 Hz
cl. isolamento / IP <i>insulation class / IP</i>	class I / IP\
peso <i>weight</i>	0,25 kg

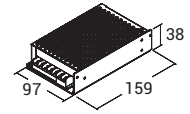

controllo <i>control</i>	on-off
tensione in uscita <i>output voltage</i>	24V DC
codice <i>code</i>	DRV2007
corrente in uscita <i>output current</i>	0 ÷ 4,5 A
potenza <i>power</i>	max 100 W
tensione in ingr. <i>voltage range</i>	220÷240 V - 50 / 60 Hz
cl. isolamento / IP <i>insulation class / IP</i>	class I / IP\
peso <i>weight</i>	0,56 kg

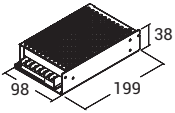

controllo <i>control</i>	on-off
tensione in uscita <i>output voltage</i>	24V DC
codice <i>code</i>	DRV2009
corrente in uscita <i>output current</i>	0 ÷ 6,5 A
potenza <i>power</i>	max 150 W
tensione in ingr. <i>voltage range</i>	220÷240 V - 50 / 60 Hz
cl. isolamento / IP <i>insulation class / IP</i>	class I / IP\
peso <i>weight</i>	0,64 kg

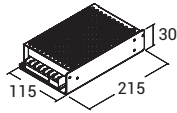

controllo <i>control</i>	on-off
tensione in uscita <i>output voltage</i>	24V DC
codice <i>code</i>	DRV2011
corrente in uscita <i>output current</i>	0 ÷ 8,4 A
potenza <i>power</i>	max 200 W
tensione in ingr. <i>voltage range</i>	220÷240 V - 50 / 60 Hz
cl. isolamento / IP <i>insulation class / IP</i>	class I / IP\
peso <i>weight</i>	0,81 kg

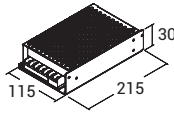

controllo <i>control</i>	on-off
tensione in uscita <i>output voltage</i>	24V DC
codice <i>code</i>	DRV2012 (*)
corrente in uscita <i>output current</i>	0 ÷ 13,4 A
potenza <i>power</i>	max 320 W
tensione in ingr. <i>voltage range</i>	220÷240 V - 50 / 60 Hz
cl. isolamento / IP <i>insulation class / IP</i>	class I / IP\
peso <i>weight</i>	0,90 kg

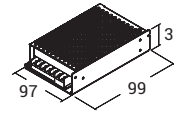

controllo <i>control</i>	on-off
tensione in uscita <i>output voltage</i>	48V DC
codice <i>code</i>	51097
corrente in uscita <i>output current</i>	0 ÷ 11 A
potenza <i>power</i>	max 50 W
tensione in ingr. <i>voltage range</i>	220÷240 V - 50 / 60 Hz
cl. isolamento / IP <i>insulation class / IP</i>	class I / IP\
peso <i>weight</i>	0,25 kg

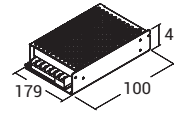

controllo <i>control</i>	on-off
tensione in uscita <i>output voltage</i>	48V DC
codice <i>code</i>	51066
corrente in uscita <i>output current</i>	0 ÷ 2,1 A
potenza <i>power</i>	max 100 W
tensione in ingr. <i>voltage range</i>	220÷240 V - 50 / 60 Hz
cl. isolamento / IP <i>insulation class / IP</i>	class I / IP\
peso <i>weight</i>	0,56 kg

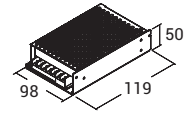

controllo <i>control</i>	on-off
tensione in uscita <i>output voltage</i>	48V DC
codice <i>code</i>	51074
corrente in uscita <i>output current</i>	0 ÷ 4,2 A
potenza <i>power</i>	max 200 W
tensione in ingr. <i>voltage range</i>	220÷240 V - 50 / 60 Hz
cl. isolamento / IP <i>insulation class / IP</i>	class I / IP\
peso <i>weight</i>	0,89 kg

(*) Raffreddamento ad aria forzata tramite ventilatore incorporato. / *Forced air cooling by built-in fan.*

Tensione Costante IP67 / *Costant Voltage IP67*

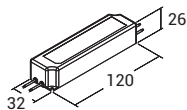

controllo <i>control</i>	on-off
tensione in uscita <i>output voltage</i>	24V DC
codice <i>code</i>	DRV2051
corrente in uscita <i>output current</i>	0 ÷ 0,75 A
potenza <i>power</i>	max 18 W
tensione in ingr. <i>voltage range</i>	220÷240 V - 50 / 60 Hz
cl. isolamento / IP <i>insulation class / IP</i>	class II / IP67
peso <i>weight</i>	0,17 kg

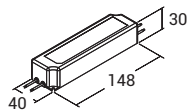

controllo <i>control</i>	on-off
tensione in uscita <i>output voltage</i>	24V DC
codice <i>code</i>	DRV2053
corrente in uscita <i>output current</i>	0 ÷ 1,5 A
potenza <i>power</i>	max 35 W
tensione in ingr. <i>voltage range</i>	220÷240 V - 50 / 60 Hz
cl. isolamento / IP <i>insulation class / IP</i>	class II / IP67
peso <i>weight</i>	0,34 kg

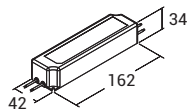

controllo <i>control</i>	on-off
tensione in uscita <i>output voltage</i>	24V DC
codice <i>code</i>	DRV2057
corrente in uscita <i>output current</i>	0 ÷ 2,5 A
potenza <i>power</i>	max 60 W
tensione in ingr. <i>voltage range</i>	220÷240 V - 50 / 60 Hz
cl. isolamento / IP <i>insulation class / IP</i>	class II / IP67
peso <i>weight</i>	0,40 kg

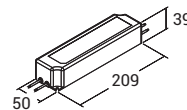

controllo <i>control</i>	on-off
tensione in uscita <i>output voltage</i>	24V DC
codice <i>code</i>	DRV2061
corrente in uscita <i>output current</i>	0 ÷ 4,2 A
potenza <i>power</i>	max 100 W
tensione in ingr. <i>voltage range</i>	220÷240 V - 50 / 60 Hz
cl. isolamento / IP <i>insulation class / IP</i>	class II / IP67
peso <i>weight</i>	0,63 kg

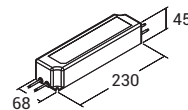

controllo <i>control</i>	on-off
tensione in uscita <i>output voltage</i>	24V DC
codice <i>code</i>	DRV2063
corrente in uscita <i>output current</i>	0 ÷ 6,3 A
potenza <i>power</i>	max 150 W
tensione in ingr. <i>voltage range</i>	220÷240 V - 50 / 60 Hz
cl. isolamento / IP <i>insulation class / IP</i>	class I / IP67
peso <i>weight</i>	1,00 kg

Kit di emergenza / *Emergency Kit*

Per power LED e moduli LED / *For power LED and LED modules*

Funzionamento in sola emergenza o in luce continua in abbinamento con alimentatori elettronici, elettronici dimmerabili. Versione regolabile con dip-switch, per power LED a corrente costante o per moduli LED a tensione costante. Intervento istantaneo ad ogni mancanza di rete. Include indicatore di ricarica a LED.

Operates in emergency only and continuous light in combination with electronic power supply and dimmerable electronics. Adjustable version with dipswitch for constant current power LED or constant voltage LED modules. Instant response to any power failure. Includes LED charging indicator.

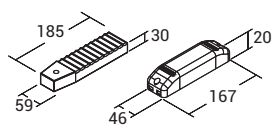

autonomia <i>operating time</i>	1 h
tempo di ricarica <i>charge time</i>	24 h
codice <i>code</i>	DRV9092
corrente in uscita <i>output current</i>	350 ÷ 85 mA (emergency mode)
tensione in uscita <i>output voltage</i>	9 ÷ 58 DC (emergency mode)
tensione in ingr. <i>voltage range</i>	220÷240 V - 50 / 60 Hz
cl. isolamento / IP <i>insulation class / IP</i>	class II / IP20
peso <i>weight</i>	0,43 kg

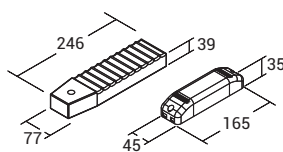

autonomia <i>operating time</i>	3 h
tempo di ricarica <i>charge time</i>	24 h
codice <i>code</i>	DRV9091
corrente in uscita <i>output current</i>	350 ÷ 85 mA (emergency mode)
tensione in uscita <i>output voltage</i>	9 ÷ 58 DC (emergency mode)
tensione in ingr. <i>voltage range</i>	220÷240 V - 50 / 60 Hz
cl. isolamento / IP <i>insulation class / IP</i>	class II / IP20
peso <i>weight</i>	0,88 kg

Conforme alle Norme / *Compliant with standards:*

EN 55015; EN 60598-2-22; EN 61000-3-2; EN 61347-2-13; EN 61347-2-7; EN 61547

Specifiche / *Specifications*

- Protetto in classe II contro le scosse elettriche per contatti diretti e indiretti
- Utilizzabile per apparecchi di illuminazione in classe di protezione I e II .
- Intervento istantaneo ad ogni mancanza di rete.
- Funzionamento in sola emergenza o in luce continua (luce continua in abbinamento con alimentatori elettronici e alimentatori elettronici dimmerabili).
- Regolazione con DIP-SWITCH, per power LED a corrente costante o per moduli LED a tensione costante.
- Batterie tipo Ni-Cd / Ni-MH "alta temperatura".
- Indicatore di ricarica a LED.
- Possibilità d'inibizione in "modo riposo" con telecomando esterno centralizzato.
- *Class II protection against electric shock for direct or indirect contact*
- *It can be used for lighting equipment in protection class I and II*
- *Instant emergency operation at mains failure.*
- *Maintained or not maintained operation (maintained operation suitable with electronic drivers or dimmable electronic drivers).*
- *Multi-power dimmable version DIP-SWITCH, constant current or constant voltage to power LED to LED modules.*
- *"High temperature" Ni-Cd / Ni-MH batteries.*
- *Charge indicator with LED.*
- *"Rest mode" facility with remote control device.*

Dati tecnici / *Technical data*

- Lunghezza cavo batteria: 280 mm / 11".
- Lunghezza cavo LED: 350 mm / 13,8".
- Foro di montaggio LED: Ø 9 mm / 0,35".
- Corrente di alimentazione: 20 mA max.
- Portata morsettiera: 1,5 mm 2 / AWG15.
- Distanza massima dall'alimentatore dalla lampada: 2 m / 6 ft.
- *Length battery cable: 280 mm / 11".*
- *Length LED cable: 350 mm / 13,8".*
- *LED mounting hole: Ø 9 mm / 0,35".*
- *Supply current: 20 mA max.*
- *Terminal blocks max. connection size: 1,5 mm 2 / AWG15.*
- *Max distance between driver and lamp: 2 mt / 6 ft.*

Schema di collegamento non permanente (solo emergenza)
Wiring diagram - Non-maintained (emergency only)

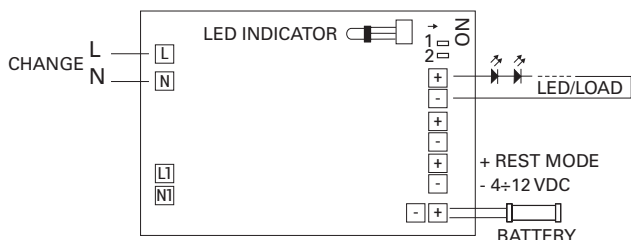

Schema di collegamento permanente (illuminazione ordinaria)
Wiring diagram - Maintained with external electronic driver

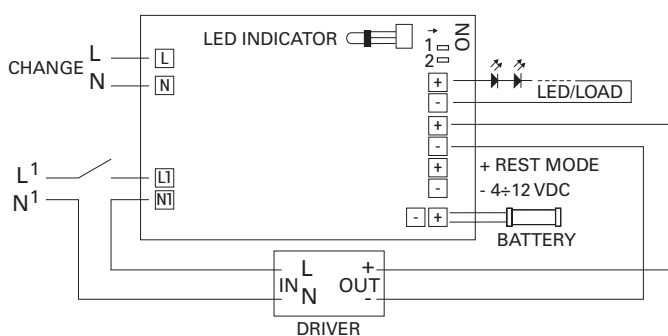

mA/Vf LED

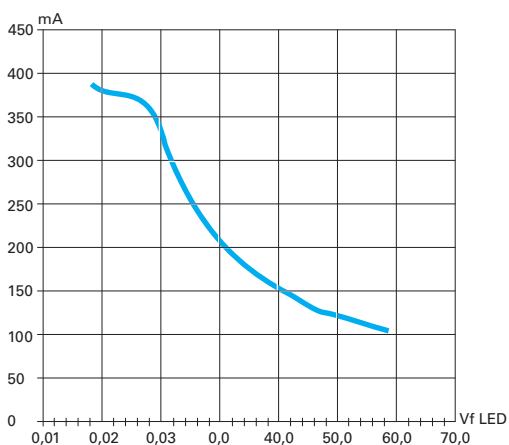

DIP-SWITCH	Working voltage during emergency (VL) Tensione di lavoro in emergenza (VL)	Output current during emergency (I) Corrente in uscita in emergenza (I)	n° LED max.	Power max. for LED modules Potenza max. per moduli LED
A	9...12 V	350 ± 10%	3/4	24V
B	9...24 V	350...250mA	7/8	30V
C	9...46 V	350...125mA	12/14	-
D	9...58 V	350...100mA	17/18	-

Touch Panels



controllo <i>control</i>	DMX512, RF 2.4GHz / RF remote control
tensione in ingr. <i>voltage range</i>	85-265V AC
codice <i>code</i>	DRV8001
potenza <i>power</i>	\
corrente in uscita <i>output current</i>	\
tensione in uscita <i>output voltage</i>	\
cl. isolamento / IP <i>insulation class / IP</i>	class II / IP20
misure L - H - P <i>size L - H - P</i>	120 x 80 x 37 mm

Deve essere completato con il Decoder DRV8122 (vedi specifiche a pagina 568)
Must be completed with the Decoder DRV8122 (see specifications to page 568)

Touch Panel capacitivo da parete, frontale in vetro ad alta resistenza. Ultra sensibile con ruota cromatica retroilluminata. Gestisce ON/OFF e regolazione luminosità 1 canale, Selezionabili 4 zone e 10 livelli di luminosità. Uscita segnale DMX conforme al protocollo DMX512 standard, è utilizzabile anche con telecomando remoto DRV8005 (non incluso). L'apparecchio si integra con il decoder DRV8122. Può pilotare fino a 20 decoder. Installabile in scatola parete 503 standard.

Ultra-sensitive capacitive high-resistance glass touch panel, wall application. Backlit color wheel set ON/OFF function and lumen flux 1 channel. 4 separate zones available, 10 different brightness levels. DMX signal output compliant with standard DMX512 protocol, compatible with remote control DRV8005 (not included) and decoder cod. DRV8122. Master up to 20 decoders. Can be installed in a standard 503 wall box.



(*) Scatola a muro 503 standard non inclusa.
() Standard 503 wall box not included.*



controllo <i>control</i>	DMX512, RF 2.4GHz / RF remote control
tensione in ingr. <i>voltage range</i>	85-265V AC
codice <i>code</i>	DRV8002
potenza <i>power</i>	\
corrente in uscita <i>output current</i>	\
tensione in uscita <i>output voltage</i>	\
cl. isolamento / IP <i>insulation class / IP</i>	class II / IP20
misure L - H - P <i>size L - H - P</i>	120 x 80 x 37 mm

Deve essere completato con il Decoder DRV8122 (vedi specifiche a pagina 568)
Must be completed with the Decoder DRV8122 (see specifications to page 568)

Touch Panel capacitivo da parete, frontale in vetro ad alta resistenza. Ultra sensibile con ruota cromatica retroilluminata. Gestisce ON/OFF e regolazione luminosità 2 canali, Selezionabili 4 zone e 10 livelli di luminosità con 10 livelli di temperatura colore. Uscita segnale DMX conforme al protocollo DMX512 standard, è utilizzabile anche con telecomando remoto DRV8006 (non incluso). L'apparecchio si integra con il decoder DRV8122. Può pilotare fino a 20 decoder. Installabile in scatola parete 503 standard.

Ultra-sensitive capacitive high-resistance glass touch panel, wall application. Backlit color wheel set ON/OFF function and lumen flux 2 channels. 4 separate zones available, can be used also with remote control cod. DRV8006 (not included). Selection of 10 brightness levels; 10 light color temperature levels. DMX signal output compliant with standard DMX512 protocol, compatible with decoder cod. DRV8122. Master up to 20 decoder. Can be installed in a standard 503 wall box.



(*) Scatola a muro 503 standard non inclusa.
() Standard 503 wall box not included.*





Deve essere completato con il Decoder DRV8122 (vedi specifiche a pagina 568)
Must be completed with the Decoder DRV8122 (see specifications to page 568)

Touch Panel capacitivo da parete, frontale in vetro ad alta resistenza. Ultra sensibile con ruota cromatica retroilluminata. Gestisce ON/OFF e regolazione luminosità 4 canali, selezionabili 4 zone e 10 livelli di luminosità con 10 livelli di cromaticità della luce. Uscita segnale DMX conforme al protocollo DMX512 standard, è utilizzabile anche con telecomando remoto DRV8007 (non incluso). L'apparecchio si integra con il decoder DRV8122. Può pilotare fino a 20 decoder. Installabile in scatola parete 503 standard.

Ultra-sensitive capacitive high-resistance glass touch panel, wall application. Backlit color wheel set ON/OFF function and single color channel. 4 separate zones available, 10 different brightness levels and 10 chromatic levels. Automatic cyclic color function. DMX signal output compliant with standard DMX512 protocol, compatible with remote control DRV8007 (not included) and decoder cod. DRV8122. Master up to 20 decoders. Can be installed in a standard 503 wall box.

controllo <i>control</i>	DMX512, RF 2.4GHz / RF remote control
tensione in ingr. <i>voltage range</i>	85-265V AC
codice <i>code</i>	DRV8003
potenza <i>power</i>	\
corrente in uscita <i>output current</i>	\
tensione in uscita <i>output voltage</i>	\
cl. isolamento / IP <i>insulation class / IP</i>	class II / IP20
misure L - H - P <i>size L - H - P</i>	120 x 80 x 37 mm



(*) Scatola a muro 503 standard non inclusa.
 (*) Standard 503 wall box not included.

Remote Controllers

CASAMBI



L'interruttore Xpress è un'interfaccia utente wireless che può essere configurata tramite l'app Casambi. I quattro pulsanti possono controllare una scena o un'animazione a scelta dell'utente o semplicemente un apparecchio, un gruppo di apparecchi o tutte le lampade insieme se lo si desidera. Il telecomando ha anche due pulsanti (su/giù) che possono controllare la temperatura del colore se l'apparecchio in questione ha l'opzione bianco regolabile. Per il controllo della temperatura del colore, premendo il pulsante "su" imposterà la temperatura del colore sul livello di colore più caldo dell'apparecchio, pulsante "giù" per il controllo del livello di colore più freddo. L'interruttore viene fornito con batteria inclusa e una piastra di montaggio a parete e può essere fissato alla piastra dotata di magneti.

The switch Xpress is a wireless user interface that can be configured via the Casambi app. The four target buttons can control a scene or an animation of the user's choice or simply one luminaire, one luminaire group or all lamps together if so desired. The switch has also up/down buttons that can either control the colour temperature if the luminaire in question has a tunable white- option or the up/down ratio if the luminaire in question has vertical control options. For the colour temperature control a tap on the 'up' button will set the colour temperature to the luminaire's warmest colour level as well as a tap on the 'down' button to the coldest colour level. The switch is supplied with the battery included and a wall mounting plate, it can be fixed to the plate equipped with magnets.



misure L - H - P <i>size L - H - P</i>	90 x 12 x 90 mm
---	-----------------

descrizione <i>description</i>	colore <i>color</i>	codice <i>code</i>
Massima distanza 50 m. in area aperta <i>50 m. max distance at open area</i>	bianco / white	DRV8306
	nero / black	DRV8307

Sistemi di controllo / Control systems

Remote Controllers



misure L - H - P
size L - H - P

122 x 53 x 17,5 mm

descrizione
description

Massima distanza 30 m. in area aperta / 30 m. max distance at open area

codice
code

DRV8008

Telecomando soft touch 1 canali a radiofrequenza opzionale per Touch Panel DRV8001. I singoli canali si attivano con leggera pressione sulla scala cromatica posta centralmente. 4 pulsanti dedicati per la selezione dell'intensità (25% / 50% / 75% / 100%). 4 pulsanti dedicati per la selezione delle zone. Fissaggio magnetico su apposita staffa a parete (inclusa). Alimentato a batteria. (non inclusa).

Optional radio frequency soft touch remote control for DRV8001 Touch Panel. Ultra sensitive with a touch color wheel in the center. 4 buttons for brightness selection (25% / 50% / 75% / 100%). 4 buttons for zone selection Magnetic fixing on special wall bracket (included). Battery powered (not included).



misure L - H - P
size L - H - P

122 x 53 x 17,5 mm

descrizione
description

Massima distanza 30 m. in area aperta / 30 m. max distance at open area

codice
code

DRV8009

Telecomando soft touch 2 canali a radiofrequenza opzionale per Touch Panel DRV8002. I singoli canali si attivano con leggera pressione sulla scala cromatica posta centralmente. 4 pulsanti dedicati per la selezione dell'intensità e del colore (bianco caldo / bianco freddo). 4 pulsanti dedicati per la selezione delle zone. Fissaggio magnetico su apposita staffa a parete (inclusa). Alimentato a batteria. (non inclusa).

Optional radio frequency soft touch remote control for DRV8002 Touch Panel. Ultra sensitive with a touch color wheel in the center. 4 buttons for brightness and colour selection (warm white / cool white). 4 buttons for zone selection. Magnetic fixing on special wall bracket (included). Battery powered (not included).



misure L - H - P
size L - H - P

122 x 53 x 17,5 mm

descrizione
description

Massima distanza 30 m. in area aperta / 30 m. max distance at open area

codice
code

DRV8010

Telecomando soft touch 4 canali a radiofrequenza opzionale per Touch Panel DRV8003. I singoli canali si attivano con leggera pressione sulla scala cromatica posta centralmente. Selezione di 10 livelli di luminosità e 10 livelli di cromaticità della luce in modalità RGBW. Funzione colore in ciclo automatico. Selezione colori statici RGBW. Fissaggio magnetico su apposita staffa a parete (inclusa). Alimentato a batteria. (non inclusa).

Optional radio frequency soft touch remote control for DRV8003 Touch Panel. Ultra sensitive with a touch color wheel in the center. Selection of 10 brightness levels and 10 colour levels in RGBW mode. Automatic cyclic colour function. RGBW static colour selection. Magnetic fixing on special wall bracket (included). Battery powered (not included).





misure L - H - P
size L - H - P

122 x 53 x 17 mm

descrizione
description

Massima distanza 30 m. in area aperta / 30 m. max distance at open area

codice
code

DRV8007

Telecomando soft touch 4 canali a radiofrequenza opzionale per Dimmer Control DRV8120. I singoli canali si attivano con leggera pressione sulla scala cromatica posta centralmente. Selezione di 10 livelli di luminosità e 10 livelli di cromaticità della luce in modalità RGBW. Funzione colore in ciclo automatico. Selezione colori statici RGBW. Fissaggio magnetico su apposita staffa a parete (inclusa). Alimentato a batteria. (non inclusa)

Optional radio frequency soft touch remote control for Dimmer Control cod. DRV8120. Ultra sensitive with a touch color wheel in the center. Selection of 10 brightness levels and 10 colour levels in RGBW mode. Automatic cyclic color function. RGBW static color selection. Magnetic fixing on special wall bracket (included). Battery powered.



misure L - H - P
size L - H - P

139 x 36 x 11 mm

descrizione
description

Massima distanza 30 m. in area aperta / 30 m. max distance at open area

codice
code

DRV8005

Telecomando soft touch 1 canale a radiofrequenza opzionale per controlli luminosità DRV8100 - DRV8105 . Fissaggio magnetico su apposita staffa a parete (inclusa). Regolazione dell'intensità ultra sensibile. Alimentato a batteria. (non inclusa)

Soft touch RF remote control for dimmer cod. DRV8105 and DRV8100. Magnetic fixing on suitable wall bracket (included). Ultra-sensitive dimming adjustment . Battery powered (not included).



misure L - H - P
size L - H - P

139 x 36 x 11 mm

descrizione
description

Massima distanza 30 m. in area aperta / 30 m. max distance at open area

codice
code

DRV8006

Telecomando soft touch 2 canali a radiofrequenza opzionale per Dimmer Control DRV8110. Fissaggio magnetico su apposita staffa a parete (inclusa). Regolazione dell'intensità dei singoli canali ultra sensibile. Alimentato a batteria. (non inclusa)

Optional radio frequency soft touch remote control for Dimmer Control cod. DRV8110. Magnetic fixing on special wall bracket (included). Regulation of intensity and ultra-sensitive chromaticity. Battery powered (not included).



Dimmer Push



controllo control	RF remote control / Push Dim.
tensione in ingr. voltage range	24V DC
codice code	DRV8100
potenza power	192W
corrente in uscita output current	8A
tensione in uscita output voltage	24V DC
cl. isolamento / IP insulation class / IP	class II / IP20
misure L - H - P size L - H - P	52 x 52 x 26 mm

Dimmer control 1 canale con funzione "push" - ricevitore a radiofrequenza in funzione "push" on. Pulsante esterno comanda accensione e regolazione luminosa. Scala dimmerazione 0-100%, uniforme e progressiva. Max 50 dimmer sincronizzabili. Funzione di trasmissione automatica; trasmette automaticamente il segnale a un altro controller fino a una distanza massima di 30 m. Abbinabile a Telecomando DRV8005 (opzionale). Un Controller accetta fino a 10 telecomandi. Protezione da surriscaldamento / sovraccarico / cortocircuito, ripristino automatico. Le ridotte dimensioni lo rendono ideale per alloggiamento in scatole derivazione a parete standard.

Dimmer control with "push" and RF function. Connect with an external switch to achieve switching on / off and 0-100% dimming function. 0-100% dimming, without stroboscopic effect. Synchronize on multiple Dimmer (max 50). Automatic transmission function; automatic transmission of the signal to another controller up to a maximum distance of 30 m.. Can be combined with Remote Control DRV8005 (optional). One Controller accepts up to 10 remote controls. Overheating / overload / short circuit protection, automatic reset. Can be inserted in standard wall junction box.

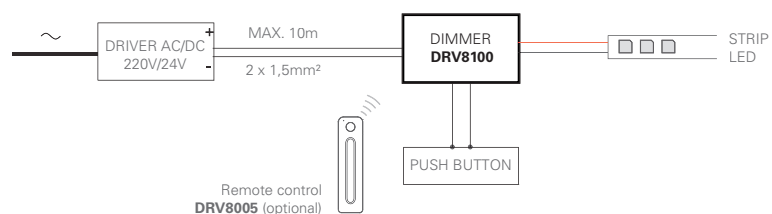

controllo control	RF remote control / Push Dim.
tensione in ingr. voltage range	24V DC
codice code	DRV8105
potenza power	360W
corrente in uscita output current	1CH, 15A
tensione in uscita output voltage	24V DC
cl. isolamento / IP insulation class / IP	class II / IP20
misure L - H - P size L - H - P	175 x 45 x 27 mm

Dimmer control 1 canale con funzione "push" - ricevitore a radiofrequenza in funzione "push" on. Pulsante esterno comanda accensione e regolazione luminosa. Scala dimmerazione 0-100%, uniforme e progressiva. Max 50 dimmer sincronizzabili. Funzione di trasmissione automatica; trasmette automaticamente il segnale a un altro controller fino a una distanza massima di 30 m. Abbinabile a Telecomando DRV8005 (opzionale). Un Controller accetta fino a 10 telecomandi. Protezione da surriscaldamento / sovraccarico / cortocircuito, ripristino automatico.

Dimmer control with "push" and RF function. Connect with an external switch to achieve switching on / off and 0-100% dimming function. 0-100% dimming, without stroboscopic effect. Synchronize on multiple Dimmer (max 50). Automatic transmission function; automatic transmission of the signal to another controller up to a maximum distance of 30 m. Can be combined with Remote Control DRV8005 (optional). One Controller accepts up to 10 remote controls. Overheating / overload / short circuit protection, automatic reset

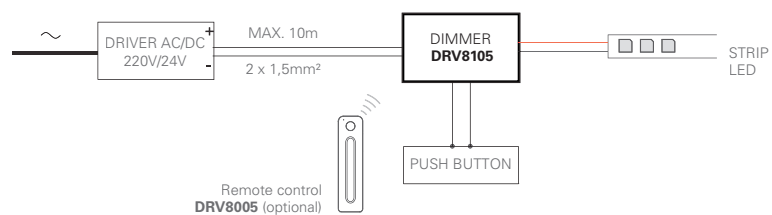



Dimmer control 2 canali con funzione "push" - ricevitore a radiofrequenza. Nella funzione "push" il pulsante esterno comanda accensione e regolazione luminosa. Scala dimmerazione 0-100%, uniforme e progressiva. Max 50 dimmer sincronizzabili. Funzione di trasmissione automatica; trasmette automaticamente il segnale a un altro controller fino a una distanza massima di 30 m. Abbinabile a Telecomando DRV8006 (opzionale). Un Controller accetta fino a 10 telecomandi. Protezione da surriscaldamento / sovraccarico / cortocircuito, ripristino automatico.

RF dimmer control with "push" function. Chromatic adjustment and 0-100% dimming, without stroboscopic effect. Overheating / overload / short circuit protection, automatic reset. Synchronization on multiple Dimmer (max 50). Automatic transmission function; automatically transmits the signal to another controller up to a maximum distance of 30 m. Connect with an external switch to achieve switching on / off , colour regulation and 0-100% dimming function. Can be combined with Remote Control DRV8006 (optional). One Controller accepts up to 10 remote controls.

controllo control	RF remote control / Push Dim.
tensione in ingr. voltage range	24V DC
codice code	DRV8110
potenza power	192W
corrente in uscita output current	2CH, 8A/CH
tensione in uscita output voltage	24V DC
cl. isolamento / IP insulation class / IP	class II / IP20
misure L - H - P size L - H - P	175 x 45 x 27 mm

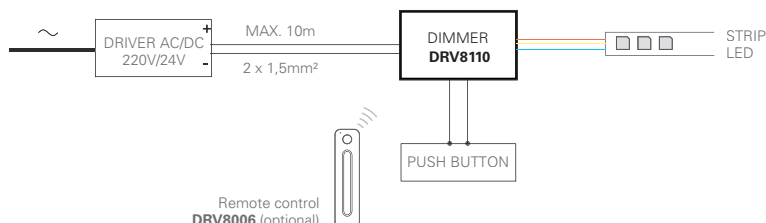

Dimmer control 4 canali e ricevitore a radiofrequenza. Scala dimmerazione singoli canali 0-100%, uniforme e progressiva. Max 50 dimmer sincronizzabili. Funzione di trasmissione automatica; trasmette automaticamente il segnale a un altro controller fino a una distanza massima di 30 m. Abbinabile a Telecomando DRV8007 (opzionale). Il componente accetta fino a 10 telecomandi. Protezione da surriscaldamento / sovraccarico / cortocircuito, ripristino automatico. Presente anche la funzione "push" attivabile con 4 pulsanti esterni che comandano accensione e regolazione singoli canali.

4 channels controller with "push" function. Chromatic adjustment and 0-100% dimming, without stroboscopic effect. Overheating / overload / short circuit protection, automatic reset. Synchronization on multiple Dimmer (max 50). Automatic transmission function; automatically transmits the signal to another controller up to a maximum distance of 30 m. Connect with 4 external buttons to achieve switching on / off , colour adjustment, 0-100% dimming function. Can be combined with Remote Control DRV8007 (optional). One Controller accepts up to 10 remote controls.

controllo control	RF remote control / Push Dim.
tensione in ingr. voltage range	24V DC
codice code	DRV8120
potenza power	4 x 180 W
corrente in uscita output current	4CH, 5A/CH
tensione in uscita output voltage	24V DC
cl. isolamento / IP insulation class / IP	class II / IP20
misure L - H - P size L - H - P	175 x 45 x 27 mm

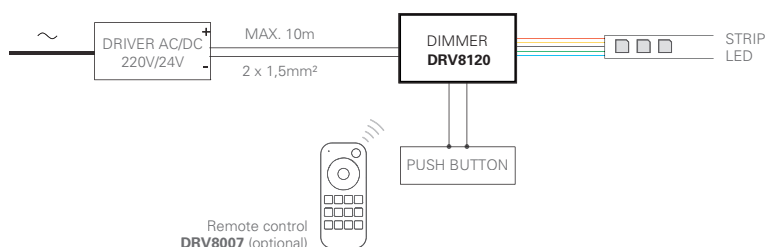

Dispositivo multicanale di controllo per la gestione colore RGBW. La funzione soft dimming garantisce un'accensione e spegnimento morbido. Dotato di 2 ingressi a pulsante normalmente aperto per comando locale.

Multi-channel control device for RGBW colour adjustment. Soft dimming. Complete with 2 N.O. buttons for local control.

controllo control	2x N.O. Push Buttons
tensione in ingr. voltage range	24V DC
codice code	DRV9008
potenza power	max 240 W
corrente in uscita output current	4x 5A (max 10A tot.)
tensione in uscita output voltage	12 / 24V DC
cl. isolamento / IP insulation class / IP	class III / IP20
misure L - H - P size L - H - P	88 x 54 x 26 mm

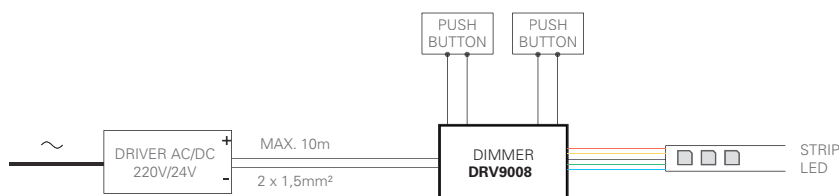

Dimmer wireless Bluetooth



controllo <i>control</i>	Smartphone Bluetooth / *PUSH LV
tensione in ingr. <i>voltage range</i>	12 / 24V DC
codice <i>code</i>	DRV8310
potenza <i>power</i>	12 V - 55 W / 24 V - 110 W
corrente in uscita <i>output current</i>	4,5 A max
tensione in uscita <i>output voltage</i>	2 x 12/24 Vdc
cl. isolamento / IP <i>insulation class / IP</i>	class III / IP20
misure L - H - P <i>size L - H - P</i>	115 x 34x 19 mm

Dimmer con WIRELESS PD tipo PWM in bassa tensione da incorporare.
 Provvisto di 2 canali di uscita indipendenti controllabili attraverso APP PAN DIGITAL
 Alimentazione in bassissima tensione di sicurezza 12/24 V.
 Utilizzabile per apparecchi di illuminazione in classe di protezione III.
 Alimentatore indipendente IP20, per uso interno.
 Fornito di coprimorsetto e serracavo. Dimensioni molto ridotte e compatte.
 Protezioni: termica e cortocircuito; contro le extra-tensioni di rete; - contro i sovraccarichi
 Regolazione della luminosità 0/1 - 100 % mediante funzione PUSH LV e APP
 Caratteristiche della regolazione mediante APP:
 possibilità di accensione e spegnimento; regolazione indipendente dei 2 canali
 (modalità SINGOLO CANALE / modalità 2 CANALI); avvio show luminoso.
 Regolazione della luminosità 0/1 - 100 % mediante la funzione PUSH LV:
 una pressione breve per accendere e spegnere; dallo stato acceso una pressione prolungata
 per abilitare la modalità selezione colore; dallo stato spento una pressione prolungata per abilitare
 la modalità sequenza colori; ripristino del colore al ritorno alimentazione.

*WIRELESS PD low voltage PWM dimmer for built-in use.
 Provided with 2 independent output channels controllable via PAN DIGITAL APP.
 Extremely low safety voltage 12/24 V. It can be used for lighting equipment in protection class III.
 IP20 independent driver, for indoor use. Supplied with terminal cover and cable retainer.
 Ultra compact size.
 Protections: against overheating and short circuits; against input voltage spikes; against overloads.
 Light regulation 0/1 - 100 % by means of PUSH LV function and APP.
 Features of remote control dimming by APP:
 can turn on and off;
 independent regulation of 2 channels (SINGLE CHANNEL mode / 2 CHANNELS mode);
 light show play.
 Light regulation 0/1 - 100 % by means of PUSH LV function: a short push to turn ON and OFF;
 a longer push from ON state to enable colour selection mode;
 a longer push from OFF state to enable colours sequence mode;
 a longer push to increase or decrease light intensity; colour memory at mains restore.*

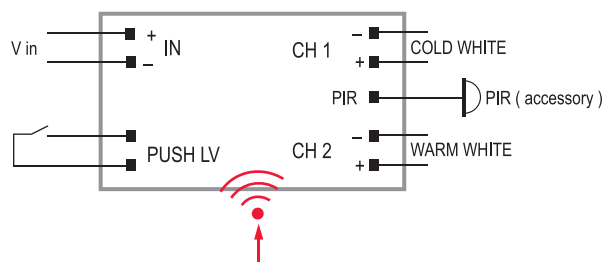

App Link:







CASAMBI



Dimmer PWM a quattro canali con controllo Casambi Bluetooth per StripLED .
 Può controllare fino a quattro canali, per applicazioni RGBW, TW.
 Il modulo è controllato con l'app Casambi che può essere scaricata gratuitamente da Apple App Store e Google Play Store.
 Il componente si integra in una rete mesh e controlla un massimo di 127 unità.
 Protetto da sovratensione, sovracorrente e corto circuito.

*Bluetooth DIMMER, Casambi enabled four channel PWM dimmer for constant voltage LED loads, LED strips. Up to four channels making for RGBW and tunable white (TW) applications.
 Can be controlled with Casambi app which can be downloaded free of charge from Apple App Store and Google Play Store.
 Up to 127 units form automatically an intelligent mesh network.
 Protected against overvoltage, overcurrent and short circuit situations.*

controllo <i>control</i>	Smartphone Bluetooth
tensione in ingr. <i>voltage range</i>	12 / 24V DC
codice <i>code</i>	DRV8312
potenza <i>power</i>	12 V - 72 W / 24 V - 144 W
corrente in uscita <i>output current</i>	6 A max
tensione in uscita <i>output voltage</i>	V in
cl. isolamento / IP <i>insulation class / IP</i>	class I / IP20
misure L - H - P <i>size L - H - P</i>	72 x 30 x 18 mm

Schema elettrico, RGBW
 Wiring diagram, RGBW

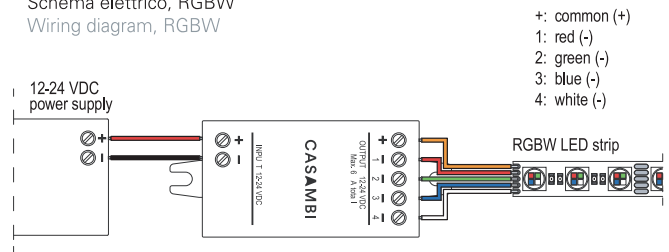

Schema elettrico, tunable white
 Wiring diagram, tunable white

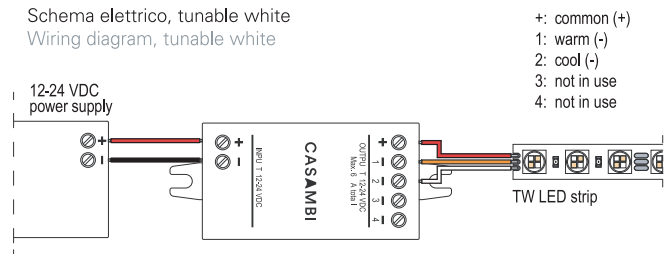

Schema elettrico, 1-4 canali separati
 Wiring diagram, 1-4 separate channels

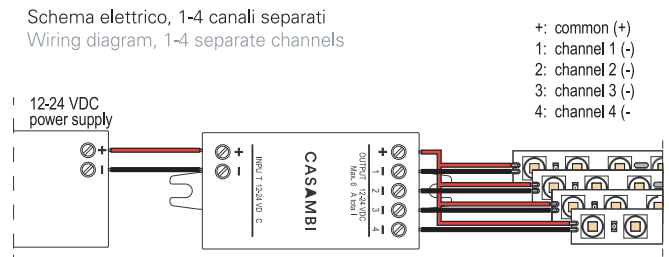

Dimensioni / Dimensions

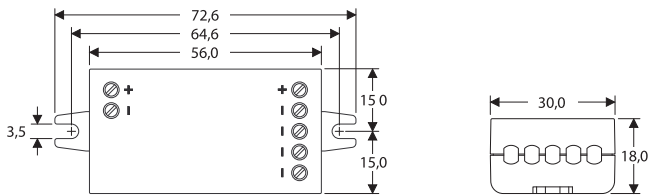

App Link:



Dimmer Mesh



Dimmer con funzione "mesh" per la gestione dell'intensità luminosa delle Stripled 24 V DC. Si possono realizzare reti sincronizzando fra loro più dimmer (fino a 4 gruppi di controllo, gestibili separatamente). Si attiva con applicazione Smartphone "Light Mesh" (disponibile su Apple, Android e Google Play). L'utente può impostare la luminosità delle Stripled e gli effetti dinamici direttamente dall'applicazione. Scala dimmerazione 0-100%. Fino a 6 effetti di dimming preimpostati.

Mesh Dimmer for managing 24 V DC Stripled luminous intensity. Mesh networks can be created by synchronizing multiple dimmers. Devices can be grouped (up to 4 control groups) and/or operated independently. "Light Mesh" APP managed by smartphone (Apple, Android and Google Play). The user can set Stripled brightness and dynamic effects directly from the APP. Allows 0-100% luminous intensity adjustment. Up to 6 preset dynamic effects.



controllo control	Smartphone Bluetooth
tensione in ingr. voltage range	24V DC
codice code	DRV8210
potenza power	360 W
corrente in uscita output current	1x15A
tensione in uscita output voltage	24V DC
cl. isolamento / IP insulation class / IP	class III / IP63
misure L - H - P size L - H - P	86 x 21 x 8,5 mm

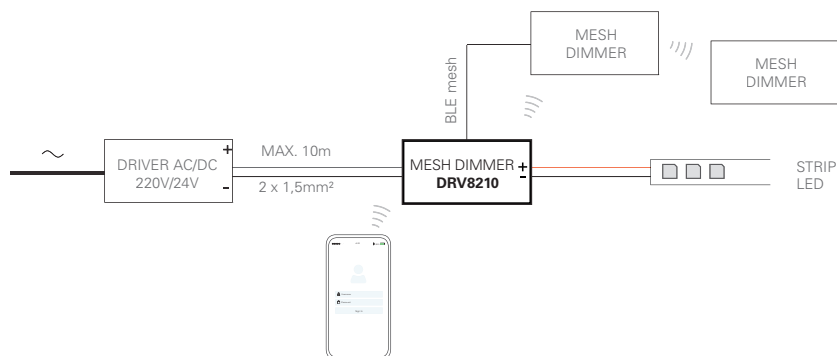

Dimmer 2 canali con funzione "mesh" per la gestione dell'intensità luminosa e della temperatura colore delle Stripled 24 V DC. Si possono realizzare reti sincronizzando fra loro più dimmer (fino a 4 gruppi di controllo, gestibili separatamente). Si attiva con applicazione Smartphone "Light Mesh" (disponibile su Apple, Android e Google Play). L'utente può impostare la luminosità, la temperatura colore insieme ad effetti dinamici direttamente dall'applicazione. Scala dimmerazione 0-100%. Fino a 6 effetti di dimming preimpostati.

Mesh Dimmer for managing 24 V DC Stripled luminous intensity and color temperature. Mesh networks can be created by synchronizing multiple dimmers. Devices can be grouped (up to 4 control groups) and/or operated independently. "Light Mesh" APP managed by smartphone (Apple, Android and Google Play). The user can set the brightness and the color temperature of the Stripled and the dynamic effects directly from the application. Allows 0-100% luminous intensity and color temperature adjustment. Up to 6 preset dynamic effects.



controllo control	Smartphone Bluetooth
tensione in ingr. voltage range	24V DC
codice code	DRV8212
potenza power	336 W
corrente in uscita output current	2x7A
tensione in uscita output voltage	24V DC
cl. isolamento / IP insulation class / IP	class III / IP63
misure L - H - P size L - H - P	86 x 21 x 8,5 mm

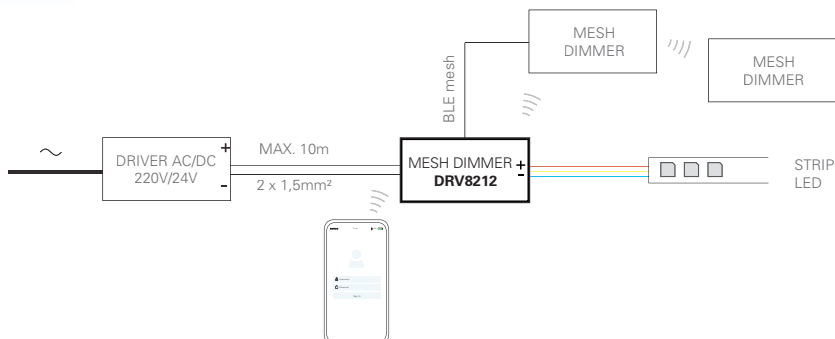



Dimmer 4 canali con funzione "mesh" per la gestione dell'intensità luminosa e dei singoli colori su Striped 24 V DC RGBW. Si possono realizzare reti sincronizzando fra loro più dimmer (fino a 4 gruppi di controllo, gestibili separatamente). Si attiva con applicazione Smartphone "Light Mesh" (disponibile su Apple, Android e Google Play). L'utente può impostare la luminosità, la temperatura colore insieme ad effetti dinamici direttamente dall'applicazione. Scala dimmerazione 0-100%. Fino a 6 effetti di dimming preimpostati.

Mesh Dimmer for managing 24 V DC Striped luminous intensity and color temperature. Mesh networks can be created by synchronizing multiple dimmers. Devices can be grouped (up to 4 control groups) and/or operated independently. "Light Mesh" APP managed by smartphone (Apple, Android and Google Play). The user can set the brightness and the color temperature of the Striped and the dynamic effects directly from the application. Allows 0-100% luminous intensity and color temperature adjustment. Up to 6 preset dynamic effects.



controllo <i>control</i>	Smartphone Bluetooth
tensione in ingr. <i>voltage range</i>	24V DC
codice <i>code</i>	DRV8215
potenza <i>power</i>	\
corrente in uscita <i>output current</i>	3x3A + 5A
tensione in uscita <i>output voltage</i>	24V DC
cl. isolamento / IP <i>insulation class / IP</i>	class III / IP63
misure L - H - P <i>size L - H - P</i>	86 x 21 x 8,5 mm

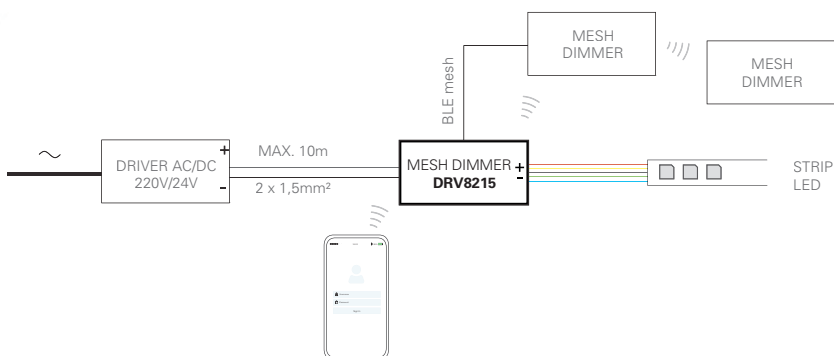

App Link:



Dimmer Kit

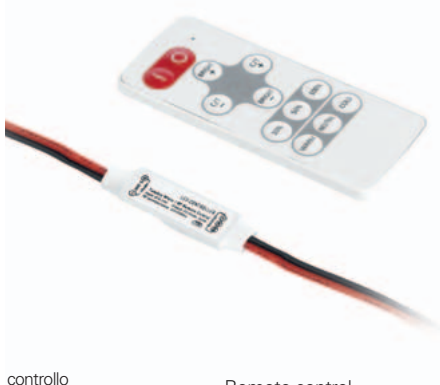

Kit per la regolazione dell'intensità luminosa delle Striped 24 V DC , (1 canale) . Si compone di telecomando a radiofrequenza e di ricevitore di segnale. L'utente può impostare la luminosità e gli effetti dinamici direttamente dal telecomando. Consente la regolazione dell'intensità luminosa su 10 livelli con 4 valori preimpostati. Fino a 8 effetti di dimming preimpostati. Massima distanza di funzionamento del telecomando fino a 15 m. in aria libera.

Dimmer Kit for managing 24 V DC Striped luminous intensity. Complete with RF control and remote dimmer for signal reception. The user can set Striped brightness and dynamic effects directly from the remote control. It achieves adjustment of luminous intensity on 10 levels with 4 preset values. Up to 8 preset dynamic effects. Maximum operating distance of the remote control up to 15 m. in open air.

controllo <i>control</i>	Remote control
tensione in ingr. <i>voltage range</i>	24V DC
codice <i>code</i>	DRV8201
potenza <i>power</i>	120 W
corrente in uscita <i>output current</i>	5A
tensione in uscita <i>output voltage</i>	24V DC
cl. isolamento / IP <i>insulation class / IP</i>	class III
misure L - H - P <i>size L - H - P</i>	45 x 13 x 5 mm

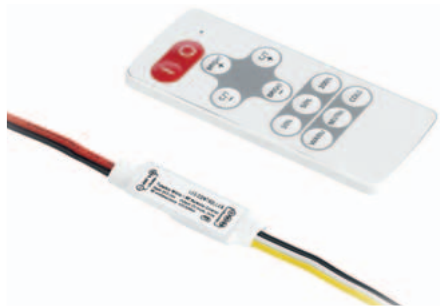
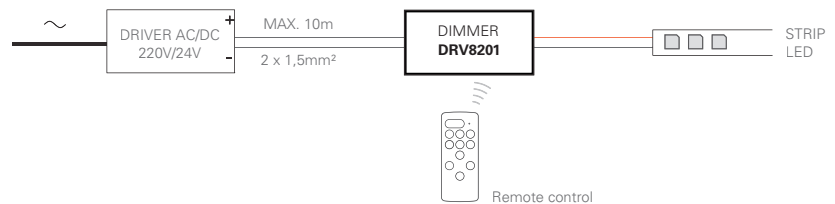

Kit per la regolazione dell'intensità luminosa delle Striped 24 V DC , (2 canali) . Si compone di telecomando a radiofrequenza e di ricevitore di segnale. L'utente può impostare la luminosità e la temperatura di colore desiderata insieme agli effetti dinamici direttamente dal telecomando. Consente la regolazione dell'intensità luminosa su 11 livelli con 6 valori preimpostati. Fino a 8 effetti di dimming preimpostati. Massima distanza di funzionamento del telecomando fino a 15 m. in aria libera.

Tunable white Dimmer Kit for managing 24 V DC Striped luminous intensity and color temperature. Complete with wireless RF control and remote dimmer for signal reception. The user can set the brightness and color temperature of the Striped and dynamic effects directly from the remote control. It achieves adjustment of luminous intensity on 11 levels with 6 preset values. Maximum operating distance from the remote control up to 15 m. in free air.

controllo <i>control</i>	Remote control
tensione in ingr. <i>voltage range</i>	24V DC
codice <i>code</i>	DRV8203
potenza <i>power</i>	144 W
corrente in uscita <i>output current</i>	2x 3A
tensione in uscita <i>output voltage</i>	24V DC
cl. isolamento / IP <i>insulation class / IP</i>	class III
misure L - H - P <i>size L - H - P</i>	45 x 13 x 5 mm

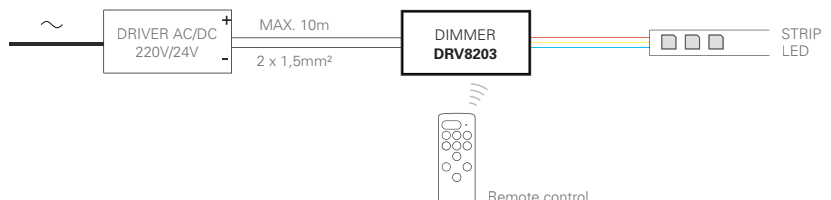



Kit per la regolazione dell'intensità luminosa e della cromaticità delle Striped 24 V DC , (4 canali - RGBW) . Si compone di telecomando a radiofrequenza e di ricevitore di segnale. L'utente può impostare la luminosità, il colore dei singoli canali e gli effetti dinamici direttamente dal telecomando. Massima distanza di funzionamento del telecomando fino a 15 m. in aria libera.

RGBW Dimmer Kit for managing 24 V DC Striped luminous intensity and colour. Complete with wireless RF control and remote dimmer for signal reception. The user can set the brightness, colour and dynamic effects of the Striped directly from the remote control. It achieves adjustment of static and dynamic colours and luminous intensity as well. Maximum operating distance from the remote control up to 15 m. in free air.

controllo <i>control</i>	Remote control
tensione in ingr. <i>voltage range</i>	24V DC
codice <i>code</i>	DRV8025
potenza <i>power</i>	192 W
corrente in uscita <i>output current</i>	4x2A
tensione in uscita <i>output voltage</i>	24V DC
cl. isolamento / IP <i>insulation class / IP</i>	class III
misure L - H - P <i>size L - H - P</i>	45 x 13 x 5 mm

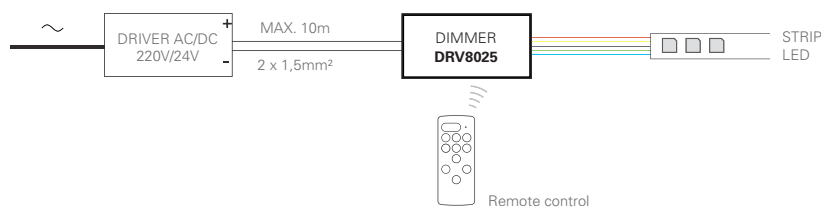

Specifiche telecomando / *Specification remote control*

Colori statici / <i>Static color</i>	30 colori / <i>30 colors</i>
Effetti dinamici / <i>Dynamic effect</i>	42 modi / <i>42 modes</i>
Grado di luminosità bianco / <i>White brightness grade</i>	10 livelli / <i>10 levels</i>
Grado di luminosità del colore / <i>Color brightness grade</i>	5 livelli / <i>5 levels</i>
Velocità / <i>Speed</i>	10 livelli / <i>10 levels</i>
Selezione diretta del colore / <i>Direct color select</i>	7 tasti diretti / <i>7 direct keys</i>

Dimmer DIN



Dimmer 1 canale per barra Din professionale; permette di pilotare StripLED monocromatiche in tensione costante mediante un comando a bus DALI o tramite un comando locale: comando a pulsante (Normalmente Aperto), segnale analogico 0÷10V o 1÷10V e potenziometro. Grazie alla funzione soft dimming garantisce un'accensione e uno spegnimento graduale. Dotato di effetto memoria in mancanza di tensione.

A professional single-channel Din rail device for regulating low voltage monochromatic LED strips through DALI protocols, or by local commands: N.O. push button, 0÷10V, 1÷10V or potentiometer. The soft dimming function ensures soft switching on and off. It also has a memory function power failure. This device has been designed for professional applications.

controllo <i>control</i>	BUS DALI / Push N.O. / 0...10V - 1...10V Analogical / 1...10V Potentiometer
tensione in ingr. <i>voltage range</i>	24V DC
codice <i>code</i>	DRV9052
potenza <i>power</i>	max 156 W
corrente in uscita <i>output current</i>	max 1x 8 A
tensione in uscita <i>output voltage</i>	24V DC
cl. isolamento / IP <i>insulation class / IP</i>	class III / IP10
misure L - H - P <i>size L - H - P</i>	92 x 36 x 62 mm

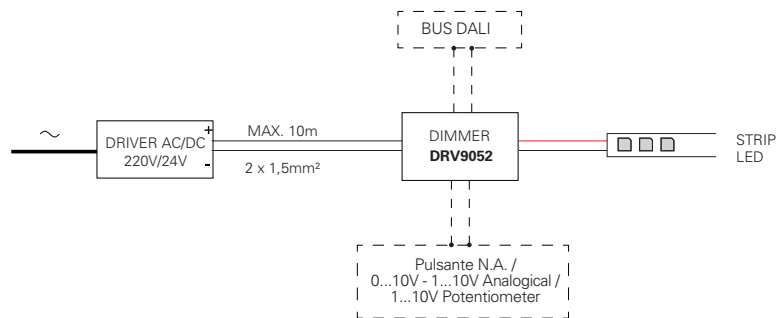

Dispositivo per barra Din professionale 4 canali; controlla separatamente le 4 uscite e permette di effettuare la più ampia regolazione della luminosità. Accetta segnali comando BUS – DALI o comando locale: a pulsante (Normalmente Aperto), segnale analogico 0÷10V o 1÷10V e potenziometro. Grazie alla funzione "soft dimming" garantisce un'accensione ed uno spegnimento graduale. Dotato di effetto memoria in mancanza di tensione. Ingresso analogico richiede 1 pulsante per ogni canale. Il componente non svolge funzioni "slave". E' indicato per la gestione di strip monocromatiche, bianco variabile, RGBW.

A professional Din rail device. Multi-channel LED control unit, can be used to regulate LED Strips white through BUS-DALI protocols. The soft dimming function ensures soft switching on and off. It also has a memory function power failure. Input selection: 4 N.O. push buttons, 0÷10V, 1÷10V or potentiometer. Analogic input need 1 button each channel. Cannot be used as "slave". Operate with striped single color, tunable white and RGBW.

controllo <i>control</i>	BUS DALI / Push N.O. / 0...10V - 1...10V Analogical / 1...10V Potentiometer
tensione in ingr. <i>voltage range</i>	24V DC
codice <i>code</i>	DRV9053
potenza <i>power</i>	max 480 W
corrente in uscita <i>output current</i>	max 4x 5 A / max 1x 20 A
tensione in uscita <i>output voltage</i>	24V DC
cl. isolamento / IP <i>insulation class / IP</i>	class III / IP10
misure L - H - P <i>size L - H - P</i>	72 x 92 x 62 mm

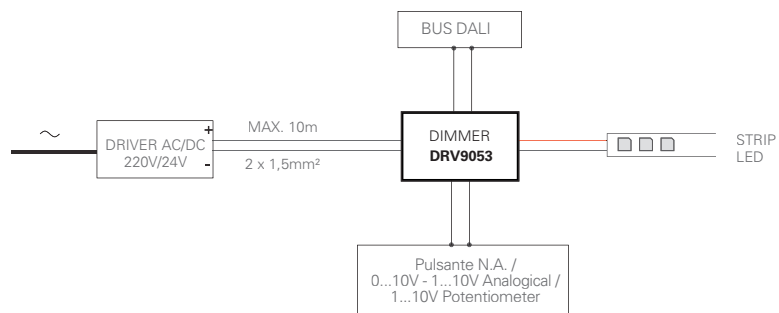



controllo control	BUS DMX / Push N.O. / 0...10V - 1...10V Analogical / 1...10V Potentiometer
tensione in ingr. voltage range	24V DC
codice code	DRV9054
potenza power	max 480 W
corrente in uscita output current	max 4x 5 A / max 1x 20 A
tensione in uscita output voltage	24V DC
cl. isolamento / IP insulation class / IP	class III / IP10
misure L - H - P size L - H - P	72 x 92 x 62 mm

Dispositivo per barra Din professionale 4 canali; controlla separatamente le 4 uscite e permette di effettuare la più ampia regolazione della luminosità. Accetta segnali comando BUS – DMX o comando locale: a pulsante (Normalmente Aperto), segnale analogico 0÷10V o 1÷10V e potenziometro . Grazie alla funzione “soft dimming” garantisce un’accensione ed uno spegnimento graduale. Dotato di effetto memoria in mancanza di tensione. Ingresso analogico richiede 1 pulsante per ogni canale. Il componente può funzionare in modalità “master – slave”. E’ indicato per la gestione di strip monocromatiche, bianco variabile, RGBW anche in impianti complessi.

A professional Din rail device. Multi-channel LED control unit, can be used to regulate LED Strips white through BUS-DMX protocols. The soft dimming function ensures soft switching on and off. It also has a memory function power failure. Input selection: 4 N.O. push buttons, 0÷10V, 1÷10V or potentiometer. Analogic input need 1 button each channel. The control unit 4 channels also works in master/slave mode . Operate with striped single color, tunable white and RGBW.

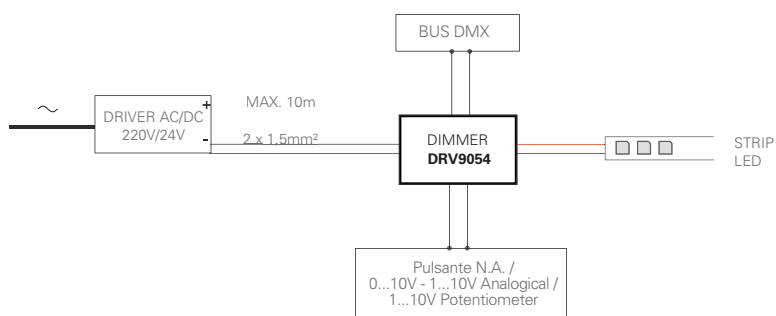

Sistemi di controllo / Control systems

Converters

Wireless PAN Digital > DALI



Interfaccia in grado di convertire il segnale tipo WIRELESS PD in segnali DALI. L'interfaccia alimenta il bus DALI, fino a 40 dispositivi (fino a 64 con alimentatore DALI aggiuntivo). Tramite applicazione PAN DIGITAL è possibile configurare e controllare la rete DALI. Adatto per dispositivi DALI DT6 - DT8 (TW - RGB). Utilizzabile per apparecchi di illuminazione in classe di protezione I e II. Protezioni: in ingresso contro sovratensioni impulsive di rete; al corto circuito e al circuito aperto; temperatura.

Interface which can convert a WIRELESS PD signal into a DALI signal. The interface supplies the DALI bus, up to 40 devices (up to 64 with additional DALI power supply). APP PAN DIGITAL allows commissioning and control of the DALI network. Suitable for DALI DT6 - DT8 (TW - RGB) devices. It can be used for lighting equipment in protection class I and II. Protections: against input over voltages from mains; against short circuit and open circuit; thermal.

controllo <i>control</i>	WIRELESS PD (PAN DIGITAL)
tensione in ingr. <i>voltage range</i>	100 ÷ 240 V
codice <i>code</i>	DRV1088
potenza <i>power</i>	/
corrente in uscita <i>output current</i>	/
tensione in uscita <i>voltage range</i>	/
cl. isolamento <i>insulation class</i>	class II
peso <i>weight</i>	0,039 kg
tipo di utilizzo <i>type of use</i>	for Built-in

Dimensioni / Dimensions

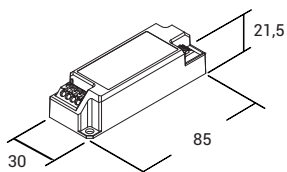

Schema di collegamento Wiring diagram

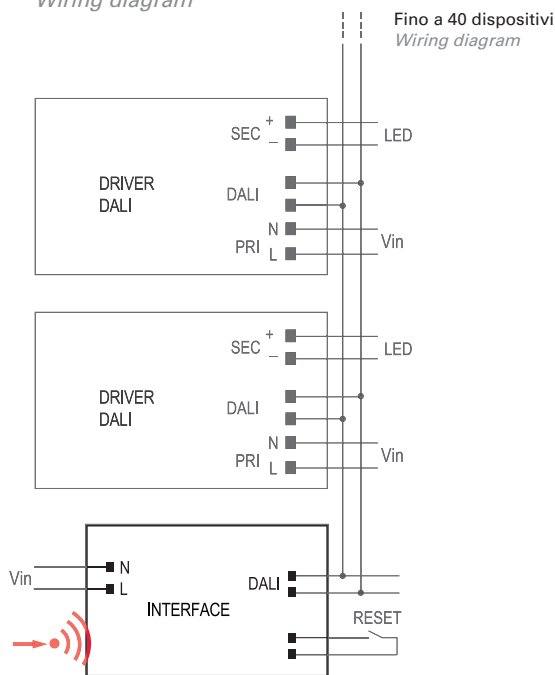

App Link:





Sistemi di controllo / Control systems

Converters

Wireless CASAMBI > DALI

CASAMBI



Controller a 2 canali abilitato Casambi Bluetooth. Il controller può pilotare 1 driver DALI oppure 2 driver 0/10, integrabile con funzione relay. Se accoppiato con Push oppure DALI sensor integra i dispositivi nella rete mesh in cui è configurato per le funzioni di presenza e gestione luminosa. Può essere controllato con l'app Casambi scaricabile gratuitamente dall'App Store di Apple e dal Google Play Store.

Is a Bluetooth controller, Casambi enabled 2 channel. The controller can control drive 1 DALI driver or 2 drivers 0/10. The product can also be configured into a DALI mode where it can be connected to a DALI LED driver or DALI sensor for presence and/or daylight harvesting functions. Can be controlled with Casambi app which can be downloaded free of charge from Apple App Store and Google Play Store.

controllo control	Wireless CASAMBI
tensione in ingr. voltage range	220 ÷ 240 V
codice code	DRV1093
potenza power	/
tensione in uscita output voltage	/
peso weight	0,035 Kg
tipo di utilizzo type of use	for Built-in
cl. isolamento / IP insulation class / IP	class II / IP20

Schema elettrico, un driver e relè
Wiring diagram, one driver and relay

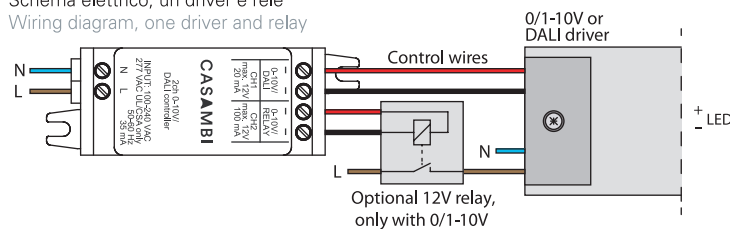

Schema elettrico, due driver (solo 0-10 V)
Wiring diagram, two drivers (only 0-10V)

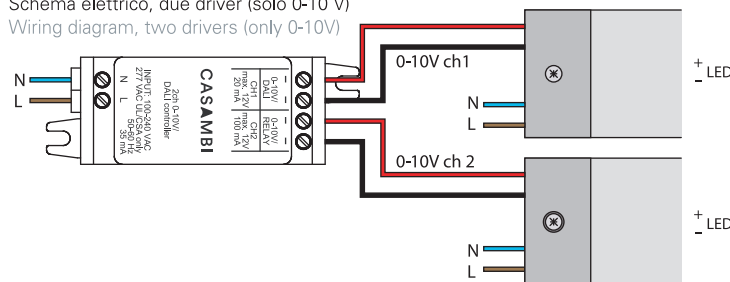

Schema elettrico, driver LED a 2 canali
Wiring diagram, 2 channel LED driver

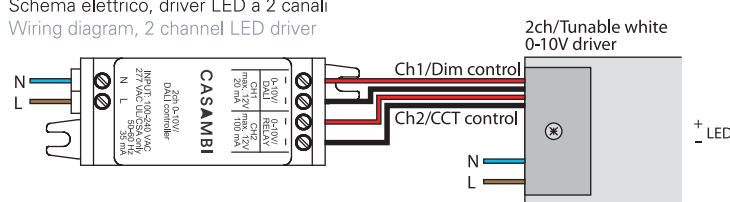

Schema elettrico, sensore DALI
Wiring diagram, DALI sensor

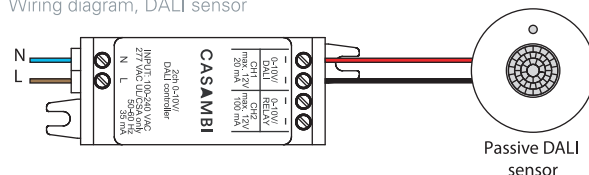

Schema elettrico, pulsante
Wiring diagram, Push Button

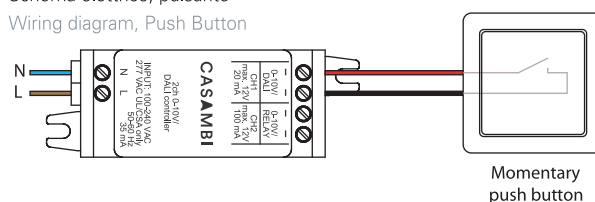

Dimensioni / Dimensions

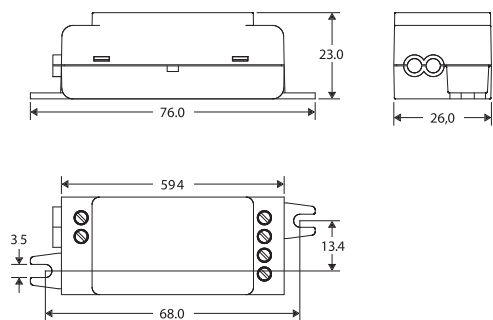

Attenzione!
per tutte le soluzioni di cablaggio.
Non collegare mai i canali di uscita in parallelo. Questo causerebbe un danneggiamento permanente sul prodotto.

Warning!
Do not connect the output channels in parallel.
This may cause permanent damage to the product.

Wireless CASAMBI > DALI

CASAMBI



Unità di controllo wireless con interfaccia DALI. Genera un bus DALI locale e ciò rende possibile la connessione diretta ad un driver LED con interfaccia DALI. Il modulo può essere usato solo in un sistema chiuso e non può essere connesso ad una rete DALI esistente. Il modulo è controllato wireless tramite applicazione CASAMBI per smartphone e tablet attraverso la tecnologia Bluetooth. I dispositivi creano automaticamente una rete mesh wireless che permette ad un numero elevato di apparecchi di essere controllato in maniera semplice ed efficiente.

A wireless control module with a DALI interface. It generates a local DALI bus which makes it possible to connect a LED driver directly to a DALI interface. The module can only be used in a closed system and cannot be connected to an existing DALI network. The module is wireless controlled using a CASAMBI app for smartphones and tablets using Bluetooth technology. The devices create an adaptive, secure and reliable wireless mesh network that can control a large number of fixtures in a simple and efficient way.



controllo <i>control</i>	WIRELESS CASAMBI
tensione in ingr. <i>voltage range</i>	220 ÷ 240 V
codice <i>code</i>	DRV1087
potenza <i>power</i>	/
tensione in uscita <i>voltage range</i>	/
cl. isolamento / IP <i>insulation class / IP</i>	class II / IP20
peso <i>weight</i>	0,048 kg
tipo di utilizzo <i>type of use</i>	for Built-in
num. max. drivers DALI <i>max. num. drivers DALI</i>	1 pc.

Dimensioni / Dimensions

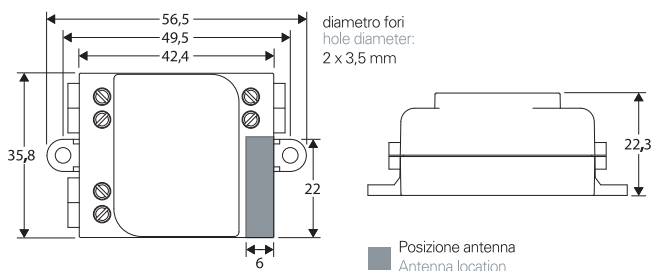

Schema elettrico, driver DALI o 0-10V alimentati direttamente Wiring diagram, directly powered DALI or 0-10V drivers

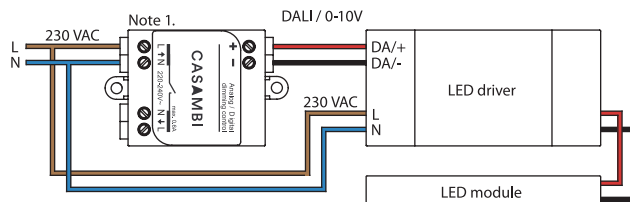

Attenzione!
Rischio di incendio.
Non collegare direttamente l'uscita di rete del modulo all'ingresso principale del driver LED. Questo causerebbe un danneggiamento permanente sul prodotto.

Warning!
Risk of fire.
Do not connect module mains output directly to LED driver main input.

App Link:



Sistemi di controllo / Control systems

Decoder



Decoder per segnale DMX512. Si integra con DRV8001, DRV8002, DRV8003. Display numerico digitale con pulsanti di settaggio. Gestisce 1,2,3,4 canali. Funzionalità stand-alone. Selezionabile frequenza PWM 2000 / 500Hz e scala dimmer logaritmica o lineare. Max 50 decoder in cascata. Protezione da surriscaldamento / cortocircuito, ripristino automatico.

Decoder for DMX512 signal. Digital numerical display with touch switches setup. Stand-alone RGB / RGBW mode and selectable 4-channel dimmer mode. Accept codes DRV8001, DRV8002, DRV8003. Selectable 2000 / 500Hz PWM frequency. Linear or logarithmic dimmer curve selectable. Max 50 cascadable decoder. Overheat / short circuit protection, automatic reset.

controllo <i>control</i>	DMX512
tensione in ingr. <i>voltage range</i>	24V DC
codice <i>code</i>	DRV8122
potenza <i>power</i>	4x 120 W
corrente in uscita <i>output current</i>	4CH, 5A/CH
tensione in uscita <i>output voltage</i>	4 x 24V DC
cl. isolamento / IP <i>insulation class / IP</i>	class II / IP20
misure L - H - P <i>size L - H - P</i>	170 x 50 x 23 mm

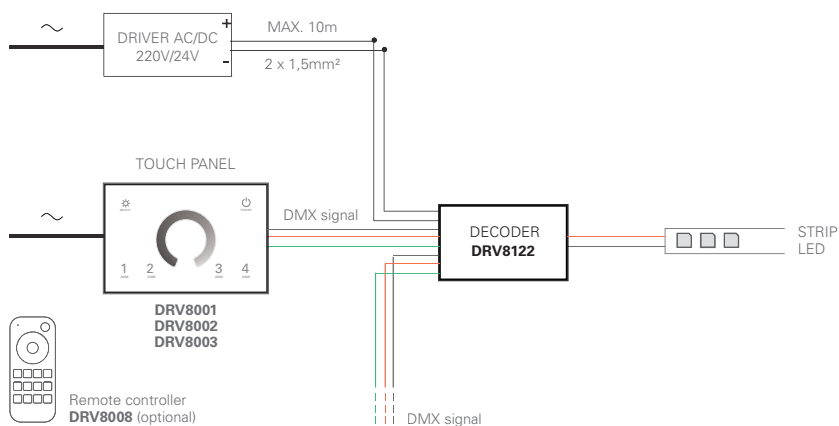

Booster



Il Booster è un amplificatore di segnale PWM da utilizzare con centralina DRV9008.

The Booster is a PWM signal amplifier to be used with DRV9008 control unit.

controllo <i>control</i>	D-PWM
tensione in ingr. <i>voltage range</i>	24V DC
codice <i>code</i>	DRV9009
potenza <i>power</i>	max 240 W
corrente in uscita <i>output current</i>	4x 5A (max 10A tot.)
tensione in uscita <i>output voltage</i>	12 / 24V DC
cl. isolamento / IP <i>insulation class / IP</i>	class III / IP20
misure L - H - P <i>size L - H - P</i>	89 x 54 x 26 mm

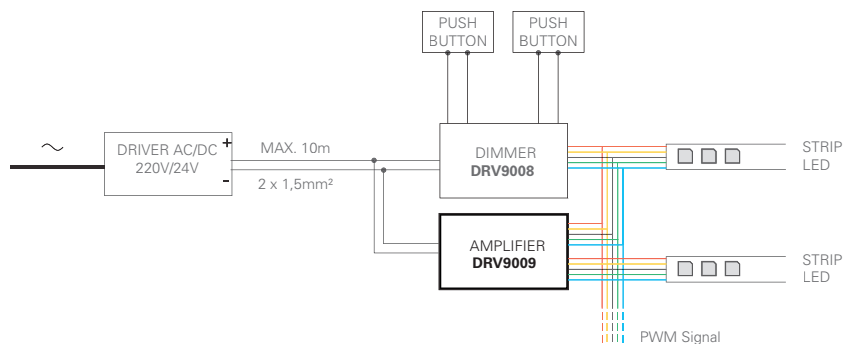

Sensors



Cavo con rilevatore di movimento per utilizzo in sistemi PAN DIGITAL.

Distanza di rilevamento: 5 m
Area di rilevamento: H: 100° - V: 82°
Zone di rilevamento: 64
Compatibile con:
serie Egon, serie Backlit; serie Led Panel; Moby 24 / 33 / 42 W, Nemo 24 / 33 / 42 W

Cable with motion detector for PAN DIGITAL system.

*Detection distance: 5 m
Detection area: H: 100° - V: 82°
Detection zones: 64
Compatible with:
Egon series, Backlit series; Led Panel series; Moby 24 / 33 / 42 W, Nemo 24 / 33 / 42 W*

descrizione description	codice code
Lunghezza cavo 0,3 m. / <i>Lenght cable 0,3 m.</i>	DEV8301
Lunghezza cavo 1 m. / <i>Lenght cable 1 m.</i>	DEV8302
Lunghezza cavo 1,6 m. / <i>Lenght cable 1,5 m.</i>	DEV8303

Sincro Cables



Cavetto di sincronizzazione singolo canale per l'utilizzo con driver dimmerabili PUSH / 1...10 V e DALI.

3 lunghezze disponibili 0,50 cm, 1,50 m e 4,00 m
Compatibile con:
Egon 23 / 29 W, serie Backlit; serie Led Panel ; Moby 24 / 33 / 42 W , Nemo 24 / 33 / 42 W

Single channel synchronization cable to use with dimmable PUSH / 1...10 V / DALI drivers.

*Available 3 lengths: 0,50 cm, 1,50 m e 4,00 m
Compatible with:
Egon 23 / 29 W, Backlit series; Led Panel series; Moby 24 / 33 / 42 W , Nemo 24 / 33 / 42 W*

descrizione description	codice code
Lunghezza cavo 0,5 m. / <i>Lenght cable 0,5 m.</i>	DRV0010
Lunghezza cavo 1,5 m. / <i>Lenght cable 1,5 m.</i>	DRV0011
Lunghezza cavo 4 m. / <i>Lenght cable 4 m.</i>	DRV0012

Sorgenti Luminose

Light Sources

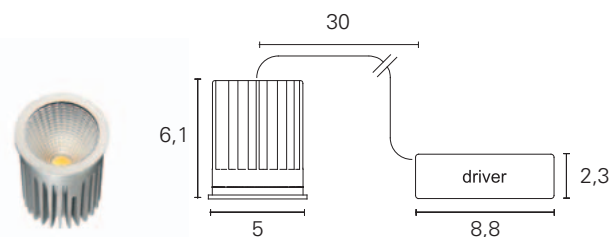

Versione Model	Codice Code	Alimentazione Power feeding	Attacco Socket	Potenza / Flusso Effettivo Power / Lumen Output	CCT CCT	Ottica Beam angle	Dimmerabile Dimmable	Classe energetica Energy Label	Durata Lifetime
Kit LED + Driver	LED8012	220÷240 V	/	9 W - 815 lm	3000 K	40 °	no	LED	L80 / B20 – 50.000 h

Compatibile Incassi pg. 119 / Compatible Recessed pg. 119



Versione Model	Codice Code	Alimentazione Power feeding	Attacco Socket	Potenza / Flusso Effettivo Power / Lumen Output	CCT CCT	Ottica Beam angle	Dimmerabile Dimmable	Classe energetica Energy Label	Durata Lifetime
GU10 LED	LED2072	AC175-250 V	GU10	7 W - 450 lm	3000 K	38 °	no	A+	15000 h

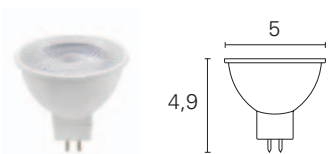

Versione Model	Codice Code	Alimentazione Power feeding	Attacco Socket	Potenza / Flusso Effettivo Power / Lumen Output	CCT CCT	Ottica Beam angle	Dimmerabile Dimmable	Classe energetica Energy Label	Durata Lifetime
GU5,3 LED	LED1072	12 V	GU5,3	7 W - 450 lm	3000 K	38 °	si	A+	15000 h

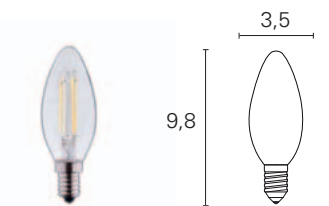

Versione Model	Codice Code	Alimentazione Power feeding	Attacco Socket	Potenza / Flusso Effettivo Power / Lumen Output	CCT CCT	Ottica Beam angle	Dimmerabile Dimmable	Classe energetica Energy Label	Durata Lifetime
Filament bulb LED	LED10010	220÷240 V	E14	4,8 W - 450 lm	2700 K	360 °	no	A++	15000 h

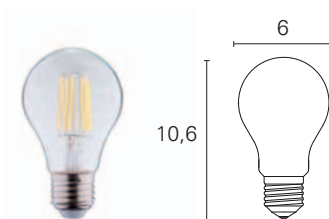

Versione Model	Codice Code	Alimentazione Power feeding	Attacco Socket	Potenza / Flusso Effettivo Power / Lumen Output	CCT CCT	Ottica Beam angle	Dimmerabile Dimmable	Classe energetica Energy Label	Durata Lifetime
Filament bulb LED	LED10015	220÷240 V	E27	7 W - 810 lm	2700 K	360 °	no	A++	15000 h

Indice Alfabetico / *Alphabetical Index*

serie <i>series</i>	pagina <i>page</i>				
Accent	296	Etna	424	Microled / Miniled	328
Alter	538	Ettore	336	Mida	541
Archer	426	Fair	460	Mikka	530
Backlit	20	Fast	476	Milla	532
Backlit UGR	24	Focus	322	Minimal	450
Barro	484	Giove	416	Moby	286
Bay	444	Gipsy	393	Nemo Adj / Fix	218
Berlin	492	Giuly	501	Nemo Comfort	242
Bike Ceiling	384	Grace	465	Nemo IP54	270
Bike Pendant	404	Hoop Ceiling	378	Nemo TL Adj / Fix	256
Bobby	302	Hoop Pendant	398	Nemo TL Comfort	264
Bond	446	Idra	470	Night	524
Boreale	469	Inge	512	Oberon	472
Bow	514	Jango	308	Odino	334
Brio	452	Jazz	497	Onda	462
Bugle	448	Karma	144	Orion	394
Cama	495	Kart Ceiling	382	Orion	466
Control System	548	Kart Pendant	402	Oslo Floor	505
Corona Ceiling	380	Lane	64	Oslo Table	529
Corona Pendant	400	Led Panel High Protection	34	Pako	487
Cross	434	Led Panel Microprismatic	32	Panel Box	44
Dama	390	Led Panel Smart	30	Paride	338
Day	370	Led Panel Tunable	36	Paris	494
Dippy	486	Loft	525	Penny Ceiling	386
Drivers	544	London	493	Penny Pendant	408
Eclis	475	Lunar Floor	506	Pill	326
Egon	200	Lunar Pendant	436	Play	388
Eli	474	Lupin	430	Pod	468
Elle	463	Lupin Wall	482	Polaris	473
Elmet	438	Lybra	126	Polka	480
Emergency Kit	546	Maiko	520	Priamo	337
Emma	499	Match	458	Professional	488
Enea	336	Medea	440	Puck Plus	58

serie <i>series</i>	pagina <i>page</i>		
Puck Smart	52	Tablet	464
Rod	454	Tina	498
Rod Floor	508	Track 4	372
Saturno	418	Track 6 Digital	374
Segno Ceiling	172	Tube	471
Segno Pendant	166	Turn	321
Segno Trimless	186	Urano	422
Segno Wall	178	Urban Pendant	442
Shade	518	Urban Table	534
Shop	316	Widot	276
Show	312	Widot AS	282
Single	320	Yab	536
Ska	356	Young	392
Ska Base	368	Zaria	522
Slim Program	334		
Soft	496		
Soft Floor	510		
Soft Table	528		
Song	334		
Spillo	467		
Stek	428		
Stem	504		
Stripled - Profili	98		
Stripled CoB Line	78		
Stripled Color Quality	88		
Stripled High Efficiency	86		
Stripled Light Line	80		
Stripled Light Line Waterproof	84		
Stripled Mini	76		
Stripled RGB - RGB+W	94		
Stripled Tunable	92		
Summer	540		
Susy	500		

Condizioni di vendita / *Sales policy*

Condizioni generali / *General terms*

Tutte le informazioni riportate sul presente catalogo sono indicative e non vincolanti per l'azienda. La stessa si riserva la facoltà di modificare o variare i prodotti per migliorare i contenuti tecnici e qualitativi anche senza preventiva informazione. Marchi, loghi e visual concept pubblicati appartengono ai legittimi proprietari. La riproduzione, anche parziale della presente pubblicazione è vietata. Pan International non risponde per eventuali danni a persone o cose causati da una non corretta installazione dei propri prodotti. La riproduzione, anche parziale, della presente pubblicazione è vietata. Visitate il nostro sito internet per verificare INFORMAZIONI TECNICHE ed ERRATA CORRIGE: www.panint.it

All information in this catalogue merely serves as an indication and it is not binding for the company. The company reserves the right to modify or vary the products to improve the technical and qualitative contents, even without prior notice. Brand names, logos and published visual concepts belong to their legitimate owners. Total or partial reproduction of this publication is forbidden. Pan International is not liable for injuries or damage due to the incorrect installation of its fixtures. No part of this catalogue may be copied. Please visit our website to check TECHNICAL INFO and ERRATA CORRIGE updates: www.panint.it

Informazioni / *Information*

Per richieste di informazioni, segnalazioni e necessità di assistenza, contattare l'agente di riferimento per la propria area geografica di appartenenza, i cui dati sono riportati su: www.panint.it

For requests, information and technical assistance please contact the reference agent for your country. List available on www.panint.it

Garanzia / *Guarantee*

Pan International garantisce che i suoi prodotti sono esenti da vizi di fabbricazione e/o di materiale in caso di uso conforme alla destinazione d'uso per il periodo indicato nella corrispondente pagina di questo catalogo con validità dalla data di emissione della fattura. Per le condizioni di garanzia consultare il sito www.panint.it

Pan International guarantees that its products are free from manufacturing and/or material defects when used according to the intended use for the period specified in the corresponding page of this catalog valid from the date of the invoice. For guarantee terms please refer to our website www.panint.it

Concept and Design
Studio grafico PAN International

Photo
Industrialfoto Firenze
Ivan Rossi Fotografo

Print
Grafiche Antiga



stampato
con il sole



Rif. CA2808-01 (ML)

Printed in Italy

Publisher
PAN International Srl
Via G. Michelucci 1
50028 Tavarnelle Val di Pesa
Firenze, Italy
www.panint.it

Information
Tel. +39 055 8059336
Fax +39 055 8059338
panint@panint.it
export@panint.it

Italy sales network
www.panint.it/rete-vendita.php



8024598157634

