

PRICE LIST  
**2022**

**A story of glass  
and light.**



 **C. CANGINI & TUCCI<sup>®</sup>**



# INDEX CONTEMPORARY COLLECTION



300G.®  
10

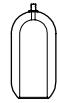

AERON®®  
11



ARABESQUE®  
13



AUF®  
15



DOLIUM®  
17



ECLISSE®  
19



ECLISSE MAX®  
21



FIJI®®  
23



FLUTE®  
25

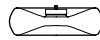

FOLD®®  
27



FREQUENCY®®  
29



GEO®  
30



LACRIMA®  
32

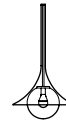

LADY LOUIS®®  
36

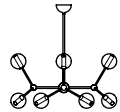

MIREA®  
38



PARIGI®  
39



PIT®®  
47

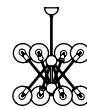

SCARLETT®  
49



TAO®  
50



ZOE®®  
52



ZOE®® VGM  
55

# INDEX STRUCTURES FOR COMPOSITIONS (from page 62 to 75)



SINGLE  
63



MULTIPLE  
67



ON PLATE  
68

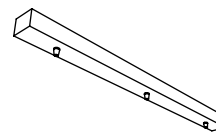

ON TRACK  
70

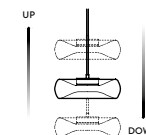

UP&DOWN SYSTEM  
75



CASAMBI CONTROLLER  
75



Dear customer,  
thank you for choosing Cangini and Tucci's product.  
In order to improve our service, find listed below the instructions to place your order:

- Always write the code followed by the colour of the glass, example:  
**FLUTE® 1393.1L**  
**glass: TRANSPARENT (01)**
- Specify the finish of the structure (where possible), example:  
**ZOE® 1309MX.3L**  
**ceiling plate: BLACK**
- Specify the colour of the electric cable (where possible), example:  
**ECLISSE® 1293.1L glass TOBACCO (16)**  
**with RED cable**
- Specify if you would like a different lamp holder (where available), example:  
**LARIMA® ~~MINI1253.1L with G9~~**  
**with E14 lamp holder**

For special compositions, it is advisable to consult us for confirmation of the feasibility and price.

Please be informed that the items not included in the catalogue, since out of production, can be still provided on request (if still possible). We invite you to contact the company for a quotation.

The price shown in the catalogue is included of canopy, electric cable and spacers where provided.

To purchase only the canopy/ceiling track/ceiling plate etc. Go to page 62 of the price list.

On request we can provide custom projects.

---

#### ADDITIONAL INFORMATION:



The prices with G9, E14 and E27 lamp holders indicated in the price list do not include bulbs.

Tracks and plates are supplied in POLISHED STAINLESS STEEL.

RESPECT THE COLOUR CHART  
PRESENT IN OUR CATALOGUE  
AVAILABLE FOR EACH PRODUCT

---

**CANGINI & TUCCI®**



---

## LEGAL DISCLAIMER

This price list contains visual representations and drawings of products and/or works that are protected under national and international intellectual and industrial property law.

© All rights reserved.

The visual representations and drawings of these products and/or works are not to be utilised, reproduced, communicated, disseminated and/or transmitted in any form whatsoever, by any means – be it electronic, mechanical or otherwise – without the express authorisation of the owner of the rights.

Some of the products and/or works presented in this price list are registered as industrial models, industrial designs and/or trademarks.  
Any violation will be prosecuted by any means made available by the Italian and international legal system.

---

---

## RECHTLICHE HINWEISE

*Die vorliegende Preisliste enthält die grafischen Darstellungen und Zeichnungen der Produkte und/oder Werke, die durch nationale und übernationale Gesetze zum geistigen und gewerblichen Eigentum geschützt sind.*

© Alle Rechte vorbehalten.

*Die grafischen Darstellungen und Zeichnungen dieser Produkte und/oder Werke dürfen nicht verwendet, reproduziert, übermittelt, verbreitet und/oder in irgendeiner Form, auf keine Weise und/oder auf elektronische, mechanische oder andere Weise übertragen werden, ohne ausdrückliche Genehmigung des Rechteinhabers.*

*Einige der Produkte und/oder Werke, die in dieser Preisliste präsentiert werden, sind als gewerbliche Muster, gewerbliche Zeichnungen und/oder als Marken eingetragen.*

*Jeder Verstoß wird mit allen Mitteln verfolgt, die vom italienischen und internationalen Rechtssystem zur Verfügung gestellt werden.*

---





---

Le lavorazioni e la metallizzazione del vetro di Cangini e Tucci sono interamente realizzate a mano da artigiani esperti. Ogni componente viene scaldato a fiamma e lavorato lentamente dedicando cura e tempo al delicato processo di trasformazione. Il valore aggiunto che questo processo - interamente manuale - conferisce al prodotto è inestimabile. La storia di ogni singolo elemento in vetro è fatta anche di piccole imperfezioni di finitura, di difformità dimensionali impercettibili che attestano la diversità di ogni singolo prodotto e, quindi, la sua unicità.

*The processing and metallization of Cangini e Tucci glass are entirely handmade by expert craftsmen. Each component is heated by flame and worked slowly, dedicating care and time to the delicate process of transformation. The added value that this process - entirely manual - gives the product is inestimable. The history of each individual glass element is also made up of small finishing imperfections, imperceptible dimensional differences that attest the diversity of each single product and, therefore, its uniqueness.*

---

# 300G.®

FINITURA METALLICA DISPONIBILE METAL FINISH AVAILABLE

Cromo Chrome

- PORTALAMPADA IN PORCELLANA / PORCELAIN LAMPHOLDER
- CAVO TRASPARENTE / TRANSPARENT CABLE
- ARTICOLI GIG NEL COLORE **FUMÈ**: SUPPLEMENTO DEL **10% SUL PREZZO DEL COLORATO** ■  
PRODUCTS GIG IN **FUME COLOR**: **10% SURCHARGE ON THE PRICE OF THE COLOURED**

WALL LAMP



CODE	Glass	Bulb	H cable cm	Net weight kg.	Gross weight kg.	Package cm	€ TRANSPARENT	€ COLOURED	€ COLOURED EDGE
AP1341.1L	Ø12 - H26 cm	E27 1 x max 70W	50 cm	0,600	1,000	55 x 21 x 19	223,00	267,00	245,00

HANGING LAMP



CODE	Glass	Bulb	H cable cm	Net weight kg.	Gross weight kg.	Package cm	€ TRANSPARENT	€ COLOURED	€ COLOURED EDGE
1343.1L	Ø14 - H32 cm	E27 1 x max 70W	150 cm	0,560	1,100	55 x 21 x 19	206,00	246,00	225,00
GIG1343.1L	Ø18 - H38 cm	E27 1 x max 70W	150 cm	0,700	1,400	26 x 26 x 47	266,00	■ 317,00	293,00
								■ <b>FUME (08) +10%</b>	

HANGING LAMP  
standard composition

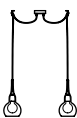

CODE	Glass	Bulb	H cable cm	Net weight kg.	Gross weight kg.	Package cm	€ TRANSPARENT	€ COLOURED	€ COLOURED EDGE
1343.2L (2x glass)	2x Ø14 - H32 cm	E27 2 x max 70W	250 cm	1,300	1,900	55 x 21 x 19	439,00	519,00	477,00
GIG1343.2L (2x glass)	2x Ø18 - H38 cm	E27 2 x max 70W	250 cm	1,340	2,400	61 x 26 x 29	559,00	■ 661,00	613,00
								■ <b>FUME (08) +10%</b>	

HANGING LAMP  
without canopy



CODE without canopy for compositions	Bulb	H cable cm	Net weight kg.	Gross weight kg.	Package cm	€ TRANSPARENT	€ COLOURED	€ COLOURED EDGE	
1343	Ø14 - H32 cm	E27 1 x max 70W	150 cm	0,560	1,100	55 x 21 x 19	184,00	224,00	203,00
GIG1343	Ø18 - H38 cm	E27 1 x max 70W	150 cm	0,700	1,400	26 x 26 x 47	244,00	■ 295,00	271,00
								■ <b>FUME (08) +10%</b>	



USE THE PRICES WITHOUT CANOPY STARTING FROM PAGE 62 TO PAGE 75 TO CREATE **CUSTOM COMPOSITIONS**

# AERON<sup>©</sup><sup>®</sup> EUIPO's registered community design

FINITURA METALLICA DISPONIBILE METAL FINISH AVAILABLE

Cromo / Oro satinato / Nichel nero satinato Chrome / Satin gold / Satin black nickel

- CAVO TRASPARENTE / TRANSPARENT CABLE

- ARTICOLI GIG E XXL NEL COLORE FUMÈ: SUPPLEMENTO DEL 10% SUL PREZZO DEL COLORATO ■  
PRODUCTS GIG AND XXL IN FUME COLOR: 10% SURCHARGE ON THE PRICE OF THE COLOURED

TABLE LAMP

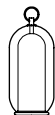

CODE	Glass	Bulb	Net weight kg. Gross weight kg.		Package cm	€ TRANSPARENT	€ COLOURED
LU1530	Ø13 - H29 cm	E14 1 x max 40W	1,210	2,150	26 x 26 x 36	420,00	495,00
LUGIG1530	Ø21 - H49 cm	E27 1 x max 60W	4,000	5,300	29 x 29 x 57	791,00	■ 949,00
LUXXL1530	Ø28 - H56 cm	E27 1 x max 60W	5,670	6,700	39 x 39 x 66	1.060,00	■ 1.270,00 ■ FUME (08) +10%

HANGING LAMP



CODE	Glass	Bulb	H cable cm	Net weight kg. Gross weight kg.		Package cm	€ TRANSPARENT	€ COLOURED
1533.1L	Ø13 - H28 cm	E14 1 x max 40W	150 cm	0,860	1,900	20 x 21 x 55	288,00	345,00
MED1533.1L	Ø15 - H34 cm	E27 1 x max 70W	150 cm	1,356	2,400	26 x 26 x 47	367,00	440,00
GIG1533.1L	Ø21 - H48 cm	E27 1 x max 70W	150 cm	2,800	3,900	29 x 29 x 57	597,00	■ 717,00
XXL1533.1L	Ø28 - H55 cm	E27 1 x max 70W	150 cm	3,570	4,700	39 x 39 x 66	890,00	■ 1.068,00 ■ FUME (08) +10%

HANGING LAMP  
without canopy

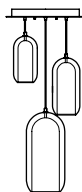

CODE	Dimensions	Bulb	H cable cm	Net weight kg. Gross weight kg.		Package cm	€ TRANSPARENT	€ COLOURED
1539MX.43.3L	Ø54 - H150 cm	E14 1 x max 40W E27 2 x max 70W	150 cm	6,830	10,200	20 x 21 x 55 / 26 x 26 x 47 / 29 x 29 x 57 / 50 x 20 x 12	1.445,00	■ 1.695,00 ■ FUME (08) +10%

PLATE: POLISHED STAINLESS STEEL

TRACK  
standard composition

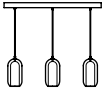

CODE	Dimensions	Bulb	H cable cm	Net weight kg.	Gross weight kg.	Package cm	€ TRANSPARENT	€ COLOURED
<b>1537.120.3L</b>	L120 - P13 -H150 cm	E14 3 x max 40W	150 cm	2,800	5,900	13 x 10 x 130 / 26 x 26 x 47	<b>1.034,00</b>	<b>1.205,00</b>
TRACK: POLISHED STAINLESS STEEL								

HANGING LAMP  
without canopy

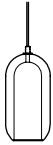

CODE without canopy for compositions	Bulb	H cable cm	Net weight kg.	Gross weight kg.	Package cm	€ TRANSPARENT	€ COLOURED	
<b>1533</b>	Ø13 - H28 cm	E14 1 x max 40W	150 cm	0,660	1,800	20 x 21 x 55	<b>266,00</b>	<b>323,00</b>
<b>MED1533</b>	Ø15 - H34 cm	E27 1 x max 70W	150 cm	1,156	2,300	26 x 26 x 47	<b>345,00</b>	<b>418,00</b>
<b>GIG1533</b>	Ø21 - H48 cm	E27 1 x max 70W	150 cm	2,600	3,800	29 x 29 x 57	<b>575,00</b>	■ <b>695,00</b>
<b>XXL1533</b>	Ø28 - H55 cm	E27 1 x max 70W	150 cm	3,370	4,600	39 x 39 x 66	<b>868,00</b>	■ <b>1.046,00</b>
								■ <b>FUME (08) +10%</b>



USE THE PRICES WITHOUT CANOPY STARTING FROM PAGE 62 TO PAGE 75 TO CREATE **CUSTOM COMPOSITIONS**

# ARABESQUE<sup>®</sup> smooth glass

FINITURA METALLICA DISPONIBILE METAL FINISH AVAILABLE

Cromo Chrome

- CAVO TRASPARENTE / TRANSPARENT CABLE

- ARTICOLI GIG E XXL NEL COLORE FUMÈ: SUPPLEMENTO DEL 10% SUL PREZZO DEL COLORATO ■  
PRODUCTS GIG AND XXL IN FUME COLOR: 10% SURCHARGE ON THE PRICE OF THE COLOURED

HANGING LAMP

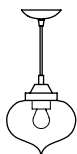

CODE	Glass	Bulb	H cable cm	Net weight kg.	Gross weight kg.	Package cm	€ TRANSPARENT	€ COLOURED
<b>1243.1L</b>	Ø16 - H26 cm	E14 1 x max 40W	150 cm	0,600	1,000	38 x 18 x 19	<b>212,00</b>	<b>255,00</b>
<b>GIG1243.1L</b>	Ø32 - H39 cm	E27 1 x max 70W	150 cm	1,365	2,800	41 x 41 x 42	<b>364,00</b>	■ <b>428,00</b>
<b>XXL1243.1L</b>	Ø38 - H42 cm	E27 1 x max 70W	150 cm	1,900	3,400	41 x 41 x 42	<b>640,00</b>	■ <b>774,00</b>

■ **FUME (08) +10%**

CEILING LAMP  
standard composition

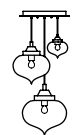

CODE	Dimensions	Bulb	H cable cm	Net weight kg.	Gross weight kg.	Package cm	€ TRANSPARENT	€ COLOURED
<b>1249MX.3L</b>	Ø58 - H150 cm	E14 1 x max 40W E27 2 x max 70W	150 cm	5,900	10,000	<b>2X</b> 41 x 41 x 42 / <b>1X</b> 50 x 20 x 12	<b>1.409,00</b>	■ <b>1.650,00</b>

PLATE: POLISHED STAINLESS STEEL

■ **FUME (08) +10%**

HANGING LAMP  
without canopy

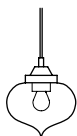

CODE without canopy for compositions	Bulb	H cable cm	Net weight kg.	Gross weight kg.	Package cm	€ TRANSPARENT	€ COLOURED
<b>1243</b>	E14 1 x max 40W	150 cm	0,600	1,000	38 x 18 x 19	<b>190,00</b>	<b>233,00</b>
<b>GIG1243</b>	E27 1 x max 70W	150 cm	1,365	2,800	41 x 41 x 42	<b>342,00</b>	■ <b>406,00</b>
<b>XXL1243</b>	E27 1 x max 70W	150 cm	1,900	3,400	41 x 41 x 42	<b>618,00</b>	■ <b>752,00</b>

■ **FUME (08) +10%**



USE THE PRICES WITHOUT CANOPY STARTING FROM PAGE 62 TO PAGE 75 TO CREATE **CUSTOM COMPOSITIONS**

# ARABESQUE<sup>®</sup> ribbed glass

FINITURA METALLICA DISPONIBILE METAL FINISH AVAILABLE

Cromo Chrome

- CAVO TRASPARENTE / TRANSPARENT CABLE

- ARTICOLI GIG E XXL NEL COLORE FUMÈ: SUPPLEMENTO DEL 10% SUL PREZZO DEL COLORATO ■  
PRODUCTS GIG AND XXL IN FUME COLOR: 10% SURCHARGE ON THE PRICE OF THE COLOURED

HANGING LAMP



CODE	Glass	Bulb	H cable cm	Net weight kg.	Gross weight kg.	Package cm	€ TRANSPARENT	€ COLOURED
R1243.1L	Ø16 - H26 cm	E14 1 x max 40W	150 cm	0,600	1,000	38 x 18 x 19	230,00	275,00
RGIG1243.1L	Ø32 - H39 cm	E27 1 x max 70W	150 cm	1,365	2,800	41 x 41 x 42	397,00	■ 473,00
RXXL1243.1L	Ø38 - H42 cm	E27 1 x max 70W	150 cm	2,215	3,500	41 x 41 x 42	640,00	■ 774,00 ■ FUME (08) +10%

CEILING LAMP  
standard composition



CODE	Dimensions	Bulb	H cable cm	Net weight kg.	Gross weight kg.	Package cm	€ TRANSPARENT	€ COLOURED
R1249MX.3L	Ø58 - H150 cm	E14 1 x max 40W E27 2 x max 70W	150 cm	7,000	10,700	2X 41 x 41 x 42 / 1X 50 x 20 x 12	1.460,00	■ 1.715,00 ■ FUME (08) +10%

HANGING LAMP  
without canopy

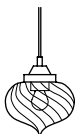

CODE without canopy for compositions	Bulb	H cable cm	Net weight kg.	Gross weight kg.	Package cm	€ TRANSPARENT	€ COLOURED
R1243	E14 1 x max 40W	150 cm	0,600	1,000	38 x 18 x 19	208,00	253,00
RGIG1243	E27 1 x max 70W	150 cm	1,365	2,800	41 x 41 x 42	375,00	■ 451,00
RXXL1243	E27 1 x max 70W	150 cm	2,215	3,500	41 x 41 x 42	618,00	■ 752,00 ■ FUME (08) +10%



USE THE PRICES WITHOUT CANOPY STARTING FROM PAGE 62 TO PAGE 75 TO CREATE CUSTOM COMPOSITIONS

# AUF<sup>©</sup>

FINITURA METALLICA DISPONIBILE *METAL FINISH AVAILABLE*

Nero opaco *Matt black*

- CAVO TESSILE NERO / *BLACK TEXTILE CABLE*

- DIMMERABILE: SÌ - *SCHEDA LED SOSTITUIBILE DA PROFESSIONISTA*  
*DIMMABLE: YES - LED IS REPLACEABLE BY PROFESSIONAL*

LED DISPONIBILI PER LA LINEA AUF<sup>©</sup> / *LEDS AVAILABLE FOR AUF<sup>©</sup>*:

LED 15W Dimmer Triac - 1275 Lm - 85 Lm/W - IP20 - CRI 90+ - 230V - 3 step MacAdam - **2700°K**

LED 15W Dimmer Triac - 1350 Lm - 90 Lm/W - IP20 - CRI 90+ - 230V - 3 step MacAdam - **3000°K**

I LUMEN INDICATI CORRISPONDONO ALL'INTENSITÀ LUMINOSA ALL'ORIGINE DELLA SCHEDA LED

*LUMEN INDICATED CORRESPONDS TO THE LUMINOUS INTENSITY AT THE ORIGIN OF THE LED BOARD*

CODE	Lampholder + Glass	LED	H cable cm	Net weight kg.	Gross weight kg.	Package cm	€ TRANSPARENT	€ COLOURED
<b>AUF.1L</b> (only cylinder)	Ø7,5 - H15 cm	LED 1x15W	150 cm	0,810	1,520	38 x 18 x 19	<b>244,00</b>	/
<b>1403.1L</b> (TUBA)	Ø22- H20 cm	LED 1x15W	150 cm	1,200	2,365	29 x 29 x 47	<b>498,00</b>	<b>596,00</b>
<b>1413.1L</b> (MINI BUATTA)	Ø19 - H27 cm	LED 1x15W	150 cm	1,210	2,255	26 x 26 x 47	<b>460,00</b>	<b>551,00</b>
<b>1443.1L</b> (LABO)	Ø21 - H23 cm	LED 1x15W	150 cm	1,170	2,380	29 x 29 x 47	<b>460,00</b>	<b>551,00</b>

HANGING LAMP

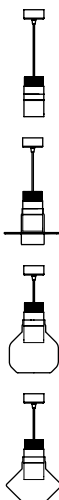

HANGING LAMP  
standard composition



CODE	Glass	LED	H cable cm	Net weight kg.	Gross weight kg.	Package cm	€ TRANSPARENT	€ COLOURED
<b>1403.2L</b> (TUBA)	2x Ø22 - H20 cm	LED 2x 15W	250 cm	2,330	4,705	<b>2X</b> 29 x 29 x 47	<b>1.025,00</b>	<b>1.221,00</b>

TRACK  
standard composition



CODE	Dimensions	LED	H cable cm	Net weight kg.	Gross weight kg.	Package cm	€ TRANSPARENT	€ COLOURED
<b>1407.120.3L</b> (TUBA)	L120 - P22 - H150 cm	LED 3x 15W	150 cm	4,670	8,825	13 x 10 x 130 / 51 x 51 x 50	<b>1.664,00</b>	<b>1.958,00</b>
TRACK: POLISHED STAINLESS STEEL								

CEILING LAMP  
standard composition

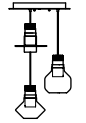

CODE	Dimensions	LED	H cable cm	Net weight kg.	Gross weight kg.	Package cm	€ TRANSPARENT	€ COLOURED
<b>AUFMX.43.3L</b>	Ø46 - H150 cm	LED 3x 15W	150 cm	5,390	10,535	50 x 50 x 12 / 51 x 51 x 50	<b>1.611,00</b>	<b>1.891,00</b>
PLATE: POLISHED STAINLESS STEEL								

CODE without canopy for compositions	LED	H cable cm	Net weight kg.	Gross weight kg.	Package cm	€ TRANSPARENT	€ COLOURED
--------------------------------------	-----	------------	----------------	------------------	------------	---------------	------------

HANGING LAMP  
without canopy



<b>1403</b> (TUBA)	Ø22 - H20 cm	LED 1x 15W	150 cm	1,200	2,365	29 x 29 x 47	<b>476,00</b>	<b>574,00</b>
--------------------	--------------	------------	--------	-------	-------	--------------	---------------	---------------

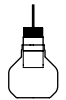

<b>1413</b> (MINI BUATTA)	Ø19 - H27 cm	LED 1x 15W	150 cm	1,210	2,255	26 x 26 x 47	<b>438,00</b>	<b>529,00</b>
---------------------------	--------------	------------	--------	-------	-------	--------------	---------------	---------------

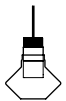

<b>1443</b> (LABO)	Ø21 - H23 cm	LED 1x 15W	150 cm	1,170	2,380	29 x 29 x 47	<b>438,00</b>	<b>529,00</b>
--------------------	--------------	------------	--------	-------	-------	--------------	---------------	---------------



USE THE PRICES WITHOUT CANOPY STARTING FROM PAGE 62 TO PAGE 75 TO CREATE **CUSTOM COMPOSITIONS**



# DOLIUM<sup>©</sup>

FINITURA METALLICA DISPONIBILE METAL FINISH AVAILABLE

Cromo Chrome

- CAVO TRASPARENTE / TRANSPARENT CABLE
- LEGNO DISPONIBILE: CHIARO (FRASSINO) / SCURO (FRASSINO TINTO WENGÉ)  
AVAILABLE WOOD: LIGHT (ASH WOOD) / DARK (WENGE STAINED ASH)
- ARTICOLI GIG E XXL NEL COLORE FUMÈ: SUPPLEMENTO DEL **10% SUL PREZZO DEL COLORATO** ■  
PRODUCTS GIG AND XXL IN FUME COLOR: **10% SURCHARGE ON THE PRICE OF THE COLOURED**
- A RICHIESTA: SENZA ELEMENTO IN LEGNO / ON DEMAND: WITHOUT WOOD ELEMENT

WALL LAMP



CODE	Glass	Bulb	H cable cm	Net weight kg.	Gross weight kg.	Package cm	€ TRANSPARENT	€ COLOURED	€ METALLIC GLASS
<b>AP1361.1L</b>	Ø13 - H35 cm	E27 1 x max 42W	50 cm	1,045	1,900	26 x 26 x 47	<b>303,00</b>	<b>362,00</b>	<b>444,00</b>

HANGING LAMP



CODE	Glass	Bulb	H cable cm	Net weight kg.	Gross weight kg.	Package cm	€ TRANSPARENT	€ COLOURED	€ METALLIC GLASS
<b>1363.1L</b>	Ø13 - H35 cm	E27 1 x max 42W	150 cm	0,990	1,800	26 x 26 x 47	<b>280,00</b>	<b>334,00</b>	<b>418,00</b>
<b>GIG1363.1L</b>	Ø17 - H38 cm	E27 1 x max 70W	150 cm	1,430	2,800	26 x 26 x 47	<b>357,00</b>	■ <b>431,00</b>	<b>536,00</b>
<b>XXL1363.1L</b>	Ø24 - H45 cm	E27 1 x max 70W	150 cm	1,730	3,000	29 x 29 x 57	<b>464,00</b>	■ <b>555,00</b>	<b>690,00</b>

■ **FUME (08) +10%**

HANGING LAMP  
standard composition

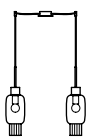

CODE	Glass	Bulb	H cable cm	Net weight kg.	Gross weight kg.	Package cm	€ TRANSPARENT	€ COLOURED	€ METALLIC GLASS
<b>1363.2L (2x glass)</b>	2x Ø13 - H35 cm	E27 2 x max 42W	250 cm	1,880	2,900	<b>2X</b> 26 x 26 x 47	<b>581,00</b>	<b>689,00</b>	<b>857,00</b>

TRACK  
standard composition

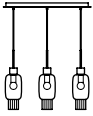

CODE	Dimensions	Bulb	H cable cm	Net weight kg.	Gross weight kg.	Package cm	€ TRANSPARENT	€ COLOURED	€ METALLIC GLASS
<b>1367.3L</b> (3x glass) <small>TRACK: POLISHED STAINLESS STEEL</small>	L70 - P13 -H150 cm	E27 3 x max 42W	150 cm	3,900	6,000	20 x 20 x 100 / 41 x 41 x 42	<b>907,00</b>	<b>1.069,00</b>	<b>1.321,00</b>

CEILING LAMP  
standard composition

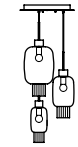

CODE	Dimensions	Bulb	H cable cm	Net weight kg.	Gross weight kg.	Package cm	€ TRANSPARENT	€ COLOURED	€ METALLIC GLASS
<b>1369MX.3L</b> <small>PLATE: POLISHED STAINLESS STEEL</small>	Ø46 - H150 cm	E27 1 x max 42W E27 2 x max 70W	150 cm	6,300	9,500	50 x 50 x 12 / 43 x 43 x 54	<b>1.285,00</b>	■ <b>1.504,00</b> ■ <b>FUME (08) +10%</b>	<b>1.828,00</b>

HANGING LAMP  
without canopy



CODE without canopy for compositions	Bulb	H cable cm	Net weight kg.	Gross weight kg.	Package cm	€ TRANSPARENT	€ COLOURED	€ METALLIC GLASS
<b>1363</b>	E27 1 x max 42W	150 cm	0,990	1,800	26 x 26 x 47	<b>255,00</b>	<b>309,00</b>	<b>393,00</b>
<b>GIG1363</b>	E27 1 x max 70W	150 cm	1,430	2,800	26 x 26 x 47	<b>332,00</b>	■ <b>406,00</b>	<b>511,00</b>
<b>XXL1363</b>	E27 1 x max 70W	150 cm	1,730	3,000	29 x 29 x 57	<b>439,00</b>	■ <b>530,00</b> ■ <b>FUME (08) +10%</b>	<b>665,00</b>



USE THE PRICES WITHOUT CANOPY STARTING FROM PAGE 62 TO PAGE 75 TO CREATE **CUSTOM COMPOSITIONS**

# ECLISSE®

FINITURA METALLICA DISPONIBILE METAL FINISH AVAILABLE

Cromo Chrome

- CAVO TRASPARENTE, A RICHIESTA: MARRONE / ROSSO, senza sovrapprezzo  
TRANSPARENT CABLE, ON DEMAND: BROWN / RED, without surcharge

- ARTICOLI GIG E XXL NEL COLORE FUMÈ: SUPPLEMENTO DEL 10% SUL PREZZO DEL COLORATO ■  
PRODUCTS GIG AND XXL IN FUME COLOR: 10% SURCHARGE ON THE PRICE OF THE COLOURED

TABLE LAMP



CODE	Dimensions	Bulb	Net weight kg. Gross weight kg.		Package cm	€ TRANSPARENT	€ COLOURED	€ METALLIC GLASS
<b>S1290.1L</b>	Ø15- H20 cm	G9 1 x max 33W	0,835	1,500	38 x 18 x 19	<b>220,00</b>	<b>260,00</b>	<b>306,00</b>

WALL LAMP



CODE	Dimensions	Bulb	Net weight kg. Gross weight kg.		Package cm	€ TRANSPARENT	€ COLOURED	€ METALLIC GLASS
<b>APS1291.1L</b>	L14 - P17 - H14 cm	G9 1 x max 33W	0,510	1,200	38 x 18 x 19	<b>198,00</b>	<b>228,00</b>	<b>284,00</b>

HANGING LAMP

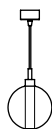

CODE	Glass	Bulb	H cable cm	Net weight kg. Gross weight kg.		Package cm	€ TRANSPARENT	€ COLOURED	€ METALLIC GLASS
<b>1293.1L</b>	Ø14- H16 cm	G9 1 x max 33W	150 cm	0,510	1,200	38 x 18 x 19	<b>198,00</b>	<b>228,00</b>	<b>284,00</b>
<b>MED1293.1L</b>	Ø22 - H24 cm	G9 1 x max 33W	150 cm	0,855	1,580	29 x 29 x 47	<b>250,00</b>	<b>328,00</b>	/
<b>GIG1293.1L</b>	Ø24 - H26 cm	G9 1 x max 33W	150 cm	0,925	2,025	29 x 29 x 57	<b>270,00</b>	■ <b>357,00</b>	/
<b>XXL1293.1L</b>	Ø26 - H28 cm	G9 1 x max 33W	150 cm	1,000	2,100	41 x 41 x 42	<b>308,00</b>	■ <b>377,00</b>	/

■ FUME (08) +10%

CEILING LAMP  
standard composition

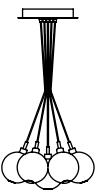

CODE	Dimensions	Bulb	H cable cm	Net weight kg.	Gross weight kg.	Package cm	€ TRANSPARENT	€ COLOURED	€ METALLIC GLASS
<b>1292.3L</b> (3x glass)	Ø28 - H150 cm	G9 3 x max 33W	150 cm	2,250	3,700	61 x 26 x 29 / 50 x 50 x 12	<b>731,00</b>	<b>821,00</b>	<b>989,00</b>
<b>1292.7L</b> (7x glass)	Ø43 - H150 cm	G9 7 x max 33W	150 cm	4,000	6,000	41 x 41 x 42 / 50 x 50 x 12	<b>1.435,00</b>	<b>1.645,00</b>	<b>2.037,00</b>
<b>1292.19L</b> (19x glass)	Ø72 - H250 cm	G9 19 x max 33W	250 cm	9,500	14,000	51 x 51 x 60 / 50 x 50 x 12	<b>3.812,00</b>	<b>4.382,00</b>	<b>5.446,00</b>
<b>1292.37L</b> (37x glass)	Ø100 - H250 cm	G9 37 x max 33W	250 cm	18,200	25,000	55 x 55 x 25 / 2X 51 x 51 x 60	<b>7.275,00</b>	<b>8.385,00</b>	<b>10.457,00</b>

PLATES: POLISHED STAINLESS STEEL

CEILING LAMP  
standard composition

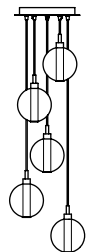

CODE	Dimensions	Bulb	H cable cm	Net weight kg.	Gross weight kg.	Package cm	€ TRANSPARENT	€ COLOURED	€ METALLIC GLASS
<b>1299.3L</b> (3x glass)	Ø27 - H150 cm	G9 3 x max 33W	150 cm	2,200	3,200	50 x 50 x 12 / 61 x 26 x 29	<b>731,00</b>	<b>821,00</b>	<b>989,00</b>
<b>1299.5L</b> (5x glass)	Ø32 - H150 cm	G9 5 x max 33W	150 cm	2,700	4,000	50 x 50 x 12 / 41 x 41 x 42	<b>1.083,00</b>	<b>1.233,00</b>	<b>1.513,00</b>
<b>1299.7L</b> (7x glass)	Ø43 - H150 cm	G9 7 x max 33W	150 cm	4,900	7,000	50 x 50 x 12 / 41 x 41 x 42	<b>1.491,00</b>	<b>1.701,00</b>	<b>2.093,00</b>
<b>1299.9L</b> (9x glass)	Ø46 - H150 cm	G9 9 x max 33W	150 cm	5,600	8,000	43 x 43 x 54 / 50 x 50 x 12	<b>1.843,00</b>	<b>2.113,00</b>	<b>2.617,00</b>
<b>1299.11L</b> (11x glass)	Ø46 - H150 cm	G9 11 x max 33W	150 cm	6,300	8,600	43 x 43 x 64 / 50 x 50 x 12	<b>2.195,00</b>	<b>2.525,00</b>	<b>3.141,00</b>

PLATE: POLISHED STAINLESS STEEL

HANGING LAMP  
without canopy

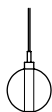

CODE without canopy for compositions	Bulb	H cable cm	Net weight kg.	Gross weight kg.	Package cm	€ TRANSPARENT	€ COLOURED	€ METALLIC GLASS	
<b>1293</b>	Ø14- H16 cm	G9 1 x max 33W	150 cm	0,510	1,200	38 x 18 x 19	<b>176,00</b>	<b>206,00</b>	<b>262,00</b>
<b>MED1293</b>	Ø22 - H24 cm	G9 1 x max 33W	150 cm	0,650	1,375	33 x 33 x 34	<b>228,00</b>	<b>306,00</b>	/
<b>GIG1293</b>	Ø24 - H26 cm	G9 1 x max 33W	150 cm	0,715	1,850	41 x 41 x 32	<b>248,00</b>	■ <b>335,00</b>	/
<b>XXL1293</b>	Ø26 - H28 cm	G9 1 x max 33W	150 cm	0,800	1,900	41 x 41 x 32	<b>286,00</b>	■ <b>355,00</b>	/

■ **FUME (08) +10%**



USE THE PRICES WITHOUT CANOPY STARTING FROM PAGE 62 TO PAGE 75 TO CREATE **CUSTOM COMPOSITIONS**

# ECLISSE MAX<sup>®</sup>

## FINITURA METALLICA STANDARD STANDARD FINISH AVAILABLE

**Cromo / Bianco opaco / Nero opaco / Cromo spazzolato** Chrome / Matt white / Matt black / Brushed chrome

## FINITURA GALVANICA A RICHIESTA GALVANIC FINISH ON DEMAND

- ROSONE SINGOLO DISPONIBILE IN: Oro satinato / Bronzo satinato / Nichel nero satinato **+21,00 Euro**  
SINGLE CANOPY AVAILABLE IN: Satin gold / Satin bronze / Satin black nickel **+21,00 Euro**

- BINARI E PIASTRE DISPONIBILI SOLO IN: Cromo / Bianco opaco / Nero opaco / Cromo spazzolato  
TRACKS AND PLATES AVAILABLE ONLY IN: Chrome / Matt white / Matt black / Brushed chrome

- STRUTTURA PORTALAMPADA IN ALLUMINIO / ALUMINUM LAMP HOLDER
- CAVO ELETTRICO COASSIALE A BASSA TENSIONE TRASPARENTE O NERO  
COAXIAL LOW VOLTAGE ELECTRIC CABLE IN TRANSPARENT OR BLACK
- DRIVER INCLUSO / DRIVER INCLUDED
- DIMMERABILE: SÌ - SCHEDA LED SOSTITUIBILE DA PROFESSIONISTA  
DIMMABLE: YES - LED IS REPLACEABLE BY PROFESSIONAL
- ARTICOLI GIG E XXL NEL COLORE **FUMÈ**: SUPPLEMENTO DEL **10% SUL PREZZO DEL COLORATO** ■  
PRODUCTS GIG AND XXL IN **FUME COLOR**: **10% SURCHARGE ON THE PRICE OF THE COLOURED**
- A RICHIESTA: **CON COMPONENTI UL** per USA **+10%** / ON DEMAND: **WITH UL COMPONENTS** for USA **+10%**

LED DISPONIBILI PER LA LINEA ECLISSE MAX<sup>®</sup> / LEDS AVAILABLE FOR ECLISSE MAX<sup>®</sup>:

LED 1 x 6W DIMM - 11,2-12,8 V - 500 mA - CRI >90 - 866 Lm - 144 Lm/W - 3 Step MacAdam - **2700°K**  
LED 1 x 6W DIMM - 11,2-12,8 V - 500 mA - CRI >90 - 866 Lm - 144 Lm/W - 3 Step MacAdam - **3000°K**

I LUMEN INDICATI CORRISPONDONO ALL'INTENSITÀ LUMINOSA ALL'ORIGINE DELLA SCHEDA LED  
LUMEN INDICATED CORRESPONDS TO THE LUMINOUS INTENSITY AT THE ORIGIN OF THE LED BOARD

PER **VERSIONE G9** VEDI "ECLISSE" A PAGINA 19  
FOR **G9 VERSION** SEE "ECLISSE" ON PAGE 19

CODE	Dimensions	LED	Net weight kg.	Gross weight kg.	Package cm	€ TRANSPARENT	€ COLOURED	€ METALLIC GLASS
<b>LU1560.1L</b>	Ø22 - H27 cm	LED 1 x 6W with dimmer push button	1,200	2,200	26 x 26 x 47	<b>301,00</b>	<b>384,00</b>	<b>415,00</b>
<b>AP1561.1L</b>	L22 - P27 - H22 cm	LED 1 x 6W	1,090	1,815	26 x 26 x 47	<b>262,00</b>	<b>345,00</b>	<b>376,00</b>

TABLE LAMP



WALL LAMP



HANGING LAMP

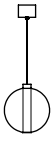

CODE	Glass	LED	H cable cm	Net weight kg.	Gross weight kg.	Package cm	€ TRANSPARENT	€ COLOURED	€ METALLIC GLASS
<b>1563.1L</b>	Ø22 - H24 cm	LED 1 x 6W	200 cm	0,855	1,580	29 x 29 x 47	<b>264,00</b>	<b>347,00</b>	<b>378,00</b>
<b>GIG1563.1L</b>	Ø24 - H26 cm	LED 1 x 6W	200 cm	0,925	2,025	29 x 29 x 57	<b>285,00</b>	■ <b>378,00</b>	<b>409,00</b>
<b>XXL1563.1L</b>	Ø26 - H28 cm	LED 1 x 6W	200 cm	1,000	2,100	41 x 41 x 42	<b>326,00</b>	■ <b>399,00</b>	<b>430,00</b>

■ **FUME (08) +10%**

CEILING LAMP  
standard composition

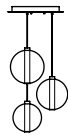

CODE	Dimensions	LED	H cable cm	Net weight kg.	Gross weight kg.	Package cm	€ TRANSPARENT	€ COLOURED	€ METALLIC GLASS
<b>1569MX.43.3L</b> (3x glass)	Ø50 - H150 cm	LED 3 x 6W	200 cm	4,635	5,825	50 x 50 x 12 / 29 x 29 x 47 / 29 x 29 x 57 / 41 x 41 x 42	<b>1.068,00</b>	■ <b>1.317,00</b>	<b>1.410,00</b>
<b>1569MX.50.5L</b> (5x glass)	Ø56 - H150 cm	LED 5 x 6W	200 cm	8,555	9,890	55 x 55 x 25 / 41 x 41 x 42 / 2X 29 x 29 x 47 / 2X 29 x 29 x 57	<b>1.670,00</b>	■ <b>2.095,00</b>	<b>2.250,00</b>

PLATE: POLISHED STAINLESS STEEL

■ **FUME (08) +10%**

TRACK  
standard composition

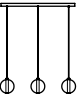

CODE	Dimensions	LED	H cable cm	Net weight kg.	Gross weight kg.	Package cm	€ TRANSPARENT	€ COLOURED	€ METALLIC GLASS
<b>1567.120.3L</b> (3x glass)	L123 - P22 - H150 cm	LED 3 x 6W	200 cm	3,400	6,165	10 x 13 x 130 / 3X 29 x 29 x 47	<b>962,00</b>	<b>1.211,00</b>	<b>1.304,00</b>

TRACK: POLISHED STAINLESS STEEL

HANGING LAMP  
without canopy

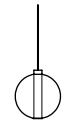

CODE without canopy for compositions	LED	H cable cm	Net weight kg.	Gross weight kg.	Package cm	€ TRANSPARENT	€ COLOURED	€ METALLIC GLASS	
<b>1563</b>	Ø22 - H24 cm	LED 1 x 6W	200 cm	0,650	1,375	29 x 29 x 47	<b>242,00</b>	<b>325,00</b>	<b>356,00</b>
<b>GIG1563</b>	Ø24 - H26 cm	LED 1 x 6W	200 cm	0,715	1,850	29 x 29 x 57	<b>263,00</b>	■ <b>356,00</b>	<b>387,00</b>
<b>XXL1563</b>	Ø26 - H28 cm	LED 1 x 6W	200 cm	0,800	1,900	41 x 41 x 42	<b>304,00</b>	■ <b>377,00</b>	<b>408,00</b>

■ **FUME (08) +10%**



USE THE PRICES WITHOUT CANOPY STARTING FROM PAGE 62 TO PAGE 75 TO CREATE **CUSTOM COMPOSITIONS**

**FIJI**®<sup>®</sup><sup>®</sup><sup>®</sup>

EUIPO's registered community design

**FINITURA METALLICA DISPONIBILE** METAL FINISH AVAILABLE**Cromo / Nero** Chrome / Black

- CAVO ELETTRICO IN GOMMA NERO / BLACK RUBBER ELECTRIC CABLE
- STRUTTURA PORTALAMPADA IN ALLUMINIO / ALUMINUM LAMP HOLDER
- DIFFUSORE IN VETRO SABBIATO / GLASS DIFFUSER IN SANDED GLASS
- ARTICOLI GIG E XXL NEL COLORE **FUMÈ**: SUPPLEMENTO DEL **10% SUL PREZZO DEL COLORATO** ■  
PRODUCTS GIG AND XXL IN **FUME** COLOR: **10% SURCHARGE ON THE PRICE OF THE COLOURED**
- DIMMERABILE: SÌ - SCHEDA LED SOSTITUIBILE DA PROFESSIONISTA  
DIMMABLE: YES - LED IS REPLACEABLE BY PROFESSIONAL
- DRIVER INCLUSO / DRIVER INCLUDED
- COMPATIBILE CON **CASAMBI** / COMPATIBLE WITH **CASAMBI**
- A RICHIESTA: DISPONIBILE CON DALI / ON DEMAND: AVAILABLE WITH DALI
- A RICHIESTA: **CON COMPONENTI UL** per USA **+10%** / ON DEMAND: **WITH UL COMPONENTS** for USA **+10%**

LED DISPONIBILI PER LA LINEA FIJI® / LEDS AVAILABLE FOR FIJI®:

LED 12,8W Dimmer Triac - 1615 Lm -126 Lm/W - IP20 - CC 350mA - CRI Typ.95 - 32-40V - 180° - **2700°K**LED 12,8W Dimmer Triac - 1615 Lm -126 Lm/W - IP20 - CC 350mA - CRI Typ.95 - 32-40V - 180° - **3000°K**

I LUMEN INDICATI CORRISPONDONO ALL'INTENSITÀ LUMINOSA ALL'ORIGINE DELLA SCHEDA LED

LUMEN INDICATED CORRESPONDS TO THE LUMINOUS INTENSITY AT THE ORIGIN OF THE LED BOARD

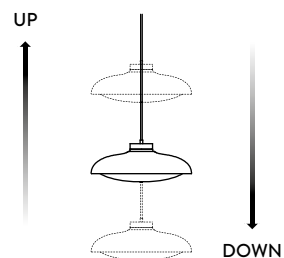
**DISPONIBILE ANCHE CON SISTEMA UP&DOWN (vedi prezzo a pag. 75)**  
**AVAILABLE WITH UP & DOWN SYSTEM (see price on page 75)**- DISPONIBILE SOLO PER FIJI® 1483 GIG1483 (peso massimo 1,8kg)  
AVAILABLE ONLY FOR FIJI® 1483 GIG1483 (maximum weight 1,8kg)- CAVO DISPONIBILE IN NERO diam. 2,1mm  
CABLE AVAILABLE IN BLACK diam. 2,1mm

- CAVO COASSIALE 0,24M2 / COAXIAL CABLE 0,24M2

- REGOLAZIONE: lunghezza minima ca. 0,55m - lunghezza massima 1,90m  
ADJUSTMENT: minimum length ca. 0,55m / maximum length 1,90m

CODE	Dimensions	LED	Net weight kg. Gross weight kg.		Package cm	€ SATIN GLASS
<b>AP1481.1L</b>	Ø26 - P13 - H26 cm	LED 1 x 12,8W	0,820	1,770	31 x 31 x 32	<b>264,00</b>
<b>APGIG1481.1L</b>	Ø34 - P16 - H34cm	LED 1 x 12,8W	1,060	2,260	41 x 41 x 42	<b>372,00</b>
<b>APXXL1481.1L</b>	Ø40 - P17 - H40cm	LED 1 x 12,8W	2,310	4,210	51 x 51 x 50	<b>780,00</b>

WALL LAMP  
only diffuser

CEILING LAMP  
only diffuser



CODE	Dimensions	LED	Net weight kg. Gross weight kg.		Package cm	€ SATIN GLASS	
<b>1482.1L</b>	Ø26 - H13 cm	LED 1 x 12,8W	0,820	1,770	31 x 31 x 32	<b>264,00</b>	
<b>GIG1482.1L</b>	Ø34 - H16 cm	LED 1 x 12,8W	1,060	2,260	41 x 41 x 42	<b>372,00</b>	
<b>XXL1482.1L</b>	Ø40 - H17 cm	LED 1 x 12,8W	2,310	4,210	51 x 51 x 50	<b>780,00</b>	

CEILING LAMP  
double glass



CODE	Dimensions	LED	Net weight kg. Gross weight kg.		Package cm	€ sat/TRANSPARENT	€ sat/COLOURED
<b>1486.1L</b>	Ø28 - H13 cm	LED 1 x 12,8W	1,140	2,090	31 x 31 x 32	<b>353,00</b>	<b>412,00</b>
<b>GIG1486.1L</b>	Ø36 - H16 cm	LED 1 x 12,8W	1,670	2,870	41 x 41 x 42	<b>581,00</b>	■ <b>631,00</b>
<b>XXL1486.1L</b>	Ø46 - H17cm	LED 1 x 12,8W	3,720	5,620	51 x 51 x 50	<b>1.182,00</b>	■ <b>1.259,00</b> ■ <b>FUME (08) +10%</b>

HANGING LAMP

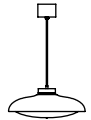

CODE	Glass	LED	H cable cm	Net weight kg. Gross weight kg.		Package cm	€ sat/TRANSPARENT	€ sat/COLOURED
<b>1483.1L</b>	Ø28 - H12 cm	LED 1 x 12,8W	150 cm	1,240	2,190	31 x 31 x 32	<b>311,00</b>	<b>367,00</b>
<b>GIG1483.1L</b>	Ø36 - H15 cm	LED 1 x 12,8W	150 cm	1,770	2,970	41 x 41 x 42	<b>560,00</b>	■ <b>606,00</b>
<b>XXL1483.1L</b>	Ø46 - H16 cm	LED 1 x 12,8W	150 cm	3,820	5,720	51 x 51 x 50	<b>1.102,00</b>	■ <b>1.168,00</b> ■ <b>FUME (08) +10%</b>

CEILING LAMP  
standard composition

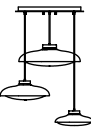

CODE	Dimensions	LED	H cable cm	Net weight kg. Gross weight kg.		Package cm	€ sat/TRANSPARENT	€ sat/COLOURED
<b>1489MX.50.3L</b> <small>PLATE: POLISHED STAINLESS STEEL</small>	Ø78 - H150 cm	LED 3 x 12,8W	150 cm	11,830	17,080	31 x 31 x 32 / 41 x 41 x 42 / 51 x 51 x 50 / 55 x 55 x 25	<b>2.263,00</b>	■ <b>2.431,00</b> ■ <b>FUME (08) +10%</b>

TRACK  
standard composition



CODE	Dimensions	LED	H cable cm	Net weight kg. Gross weight kg.		Package cm	€ sat/TRANSPARENT	€ sat/COLOURED
<b>1487.120.3L</b> (3x glass) <small>TRACK: POLISHED STAINLESS STEEL</small>	L128 - P28 - H150 cm	LED 3 x 12,8W	150 cm	4,790	8,945	<b>3X</b> 31 x 31 x 32 / <b>1X</b> 13 x 10 x 130	<b>1.103,00</b>	<b>1.271,00</b>

HANGING LAMP  
without canopy

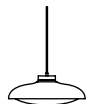

CODE without canopy for compositions	LED	H cable cm	Net weight kg. Gross weight kg.		Package cm	€ sat/TRANSPARENT	€ sat/COLOURED
<b>1483</b>	LED 1 x 12,8W	150 cm	1,240	2,190	31 x 31 x 32	<b>289,00</b>	<b>345,00</b>
<b>GIG1483</b>	LED 1 x 12,8W	150 cm	1,770	2,970	41 x 41 x 42	<b>538,00</b>	■ <b>584,00</b>
<b>XXL1483</b>	LED 1 x 12,8W	150 cm	3,820	5,720	51 x 51 x 50	<b>1.080,00</b>	■ <b>1.146,00</b> ■ <b>FUME (08) +10%</b>



USE THE PRICES WITHOUT CANOPY STARTING FROM PAGE 62 TO PAGE 75 TO CREATE **CUSTOM COMPOSITIONS**



# FLUTE<sup>©</sup>

FINITURA METALLICA DISPONIBILE METAL FINISH AVAILABLE

Cromo / Bianco opaco / Nero opaco / Cromo spazzolato Chrome / Matt white / Matt black / Brushed chrome

- CAVO TRASPARENTE, A RICHIESTA: TESSILE NERO  
TRANSPARENT CABLE, ON DEMAND: BLACK TEXTILE

- ARTICOLI GIG E XXL NEL COLORE FUMÈ: SUPPLEMENTO DEL 10% SUL PREZZO DEL COLORATO ■  
PRODUCTS GIG AND XXL IN FUME COLOR: 10% SURCHARGE ON THE PRICE OF THE COLOURED

WALL LAMP

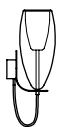

CODE	Dimensions	Bulb	H cable cm	Net weight kg.	Gross weight kg.	Package cm	€ TRANSPARENT	€ COLOURED	€ METALLIC GLASS
AP1391.1L	L12 - P16 - H38 cm	E14 1 x max 60W	50 cm	0,760	1,610	55 x 21 x 20	324,00	390,00	444,00

TABLE LAMP

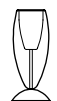

CODE	Dimensions	Bulb	Net weight kg.	Gross weight kg.	Package cm	€ TRANSPARENT	€ COLOURED	€ METALLIC GLASS
LU1390.1L	Ø12 - H31 cm	E14 1 x max 60W	0,980	1,700	26 x 26 x 47	337,00	403,00	455,00
LUGIG1390.1L	Ø16 - H39 cm	E27 1 x max 105W	1,630	2,370	26 x 26 x 47	512,00	■ 613,00 ■ FUME (08) +10%	691,00

HANGING LAMP



CODE	Glass	Bulb	H cable cm	Net weight kg.	Gross weight kg.	Package cm	€ TRANSPARENT	€ COLOURED	€ METALLIC GLASS
1393.1L	Ø12 - H27 cm	E14 1 x max 60W	150 cm	0,630	1,480	55 x 21 x 19	294,00	354,00	411,00
GIG1393.1L	Ø16 - H35 cm	E27 1 x max 105W	150 cm	1,130	1,880	26 x 26 x 47	442,00	■ 530,00	617,00
XXL1393.1L	Ø20 - H45 cm	E27 1 x max 105W	150 cm	1,790	2,830	29 x 29 x 57	641,00	■ 768,00 ■ FUME (08) +10%	857,00

HANGING LAMP  
standard composition

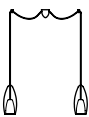

CODE	Glass	Bulb	H cable cm	Net weight kg.	Gross weight kg.	Package cm	€ TRANSPARENT	€ COLOURED	€ METALLIC GLASS
<b>1393.2L</b> (2x glass)	2x Ø12 - H27 cm	E14 2 x max 60W	250 cm	1,235	2,550	61 x 26 x 29	<b>614,00</b>	<b>734,00</b>	<b>848,00</b>
<b>1393.3L</b> (3x glass)	3x Ø12 - H27 cm	E14 3 x max 60W	250 cm	1,835	3,250	41 x 41 x 42	<b>910,00</b>	<b>1.090,00</b>	<b>1.261,00</b>
<b>GIG1393.2L</b> (2x glass)	2x Ø16 - H35 cm	E27 2 x max 105W	250 cm	2,235	3,660	<b>2X</b> 26 x 26 x 47	<b>910,00</b>	■ <b>1.086,00</b>	<b>1.260,00</b>
<b>XXL1393.2L</b> (2x glass)	2x Ø20 - H45 cm	E27 2 x max 105W	250 cm	3,555	5,560	<b>2X</b> 29 x 29 x 57	<b>1.308,00</b>	■ <b>1.562,00</b> ■ <b>FUME (08) +10%</b>	<b>1.740,00</b>

TRACK  
standard composition

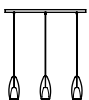

CODE	Dimensions	Bulb	H cable cm	Net weight kg.	Gross weight kg.	Package cm	€ TRANSPARENT	€ COLOURED	€ METALLIC GLASS
<b>1397.90.3L</b> (3x glass)	L90 - P12- H150	E14 3 x max 60W	150 cm	2,770	5,760	13 x 10 x 130 / 41 x 41 x 42	<b>1.018,00</b>	<b>1.198,00</b>	<b>1.369,00</b>
<b>GIG1397.120.3L</b> (3x glass)	L120 - P16- H150	E27 3 x max 105W	150 cm	4,580	7,370	13 x 10 x 130 / <b>3X</b> 26 x 26 x 47	<b>1.496,00</b>	■ <b>1.760,00</b> ■ <b>FUME (08) +10%</b>	<b>2.021,00</b>

TRACK: POLISHED STAINLESS STEEL

CEILING LAMP  
standard composition

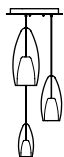

CODE	Dimensions	Bulb	H cable cm	Net weight kg.	Gross weight kg.	Package cm	€ TRANSPARENT	€ COLOURED	€ METALLIC GLASS
<b>1399MX.43.3L</b>	Ø45 - H150 cm	E27 2 x max 105W E14 1 x max 60W	150 cm	5,460	9,370	50 x 50 x 12 / 38 x 18 x 19 / 26 x 26 x 47 / 29 x 29 x 57	<b>1.570,00</b>	■ <b>1.845,00</b> ■ <b>FUME (08) +10%</b>	<b>2.078,00</b>

PLATE: POLISHED STAINLESS STEEL

HANGING LAMP  
without canopy



CODE without canopy for compositions	Bulb	H cable cm	Net weight kg.	Gross weight kg.	Package cm	€ TRANSPARENT	€ COLOURED	€ METALLIC GLASS	
<b>1393</b>	Ø12 - H27 cm	E14 1 x max 60W	150 cm	0,630	1,480	55 x 21 x 19	<b>272,00</b>	<b>332,00</b>	<b>389,00</b>
<b>GIG1393</b>	Ø16 - H35 cm	E27 1 x max 105W	150 cm	1,130	1,880	26 x 26 x 47	<b>420,00</b>	■ <b>508,00</b>	<b>595,00</b>
<b>XXL1393</b>	Ø20 - H45 cm	E27 1 x max 105W	150 cm	1,790	2,830	29 x 29 x 57	<b>619,00</b>	■ <b>746,00</b> ■ <b>FUME (08) +10%</b>	<b>835,00</b>



USE THE PRICES WITHOUT CANOPY STARTING FROM PAGE 62 TO PAGE 75 TO CREATE **CUSTOM COMPOSITIONS**

# FOLD<sup>®</sup> EUIPO's registered community design

**FINITURA METALLICA DISPONIBILE** METAL FINISH AVAILABLE

**Cromo / Nero** Chrome / Black

- CAVO ELETTRICO IN GOMMA NERO / BLACK RUBBER ELECTRIC CABLE
- STRUTTURA PORTALAMPADA IN ALLUMINIO / ALUMINUM LAMP HOLDER
- PARTE INFERIORE IN VETRO SABBIAITO / BOTTOM IN SANDED GLASS
- ARTICOLI GIG NEL COLORE **FUMÈ**: SUPPLEMENTO DEL **10% SUL PREZZO DEL COLORATO** ■  
PRODUCTS GIG AND IN **FUME COLOR**: **10% SURCHARGE ON THE PRICE OF THE COLOURED**
- DIMMERABILE: SÌ - SCHEDA LED SOSTITUIBILE DA PROFESSIONISTA  
DIMMABLE: YES - LED IS REPLACEABLE BY PROFESSIONAL
- DRIVER INCLUSO / DRIVER INCLUDED
- COMPATIBILE CON **CASAMBI** / COMPATIBLE WITH **CASAMBI**
- A RICHIESTA: DISPONIBILE CON DALI / ON DEMAND: AVAILABLE WITH DALI
- A RICHIESTA: **CON COMPONENTI UL** per USA **+10%** / ON DEMAND: **WITH UL COMPONENTS** for USA **+10%**

LED DISPONIBILI PER LA LINEA FOLD<sup>®</sup> / LEDS AVAILABLE FOR FOLD<sup>®</sup>:

**PER APPLIQUE:** LED 12,8W Dimmer Triac - 1615 Lm - 126 Lm/W - IP20 - CC 350mA - CRI Typ.95 - 32-40V - 180° - **2700°K o/or 3000°K**

**PER PLAFONIERE/SOSPENSIONI/BINARI:** LED 17,4W Dimmer Triac - 2370 Lm - 134,3 Lm/W - IP20 - CC 500mA - CRI Typ.95 - 32-40V - 180° - **2700°K o/or 3000°K**

I LUMEN INDICATI CORRISPONDONO ALL'INTENSITÀ LUMINOSA ALL'ORIGINE DELLA SCHEDA LED

LUMEN INDICATED CORRESPONDS TO THE LUMINOUS INTENSITY AT THE ORIGIN OF THE LED BOARD

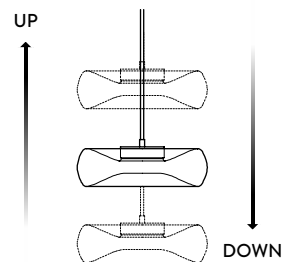

**DISPONIBILE ANCHE CON SISTEMA UP&DOWN (vedi prezzo a pag. 75)**  
**AVAILABLE WITH UP & DOWN SYSTEM (see price on page 75)**

- DISPONIBILE SOLO PER FOLD<sup>®</sup> 1513 GIG1513 (peso massimo 1,8kg)  
AVAILABLE ONLY FOR FOLD<sup>®</sup> 1513 GIG1513 (maximum weight 1,8kg)

- CAVO DISPONIBILE IN NERO diam. 2,1mm  
CABLE AVAILABLE IN BLACK diam. 2,1mm

- CAVO COASSIALE 0,24M2 / COAXIAL CABLE 0,24M2

- REGOLAZIONE: lunghezza minima ca. 0,55m - lunghezza massima 1,90m  
ADJUSTMENT: minimum length ca. 0,55m / maximum length 1,90m

WALL LAMP



CODE	Dimensions	LED	Net weight kg.	Gross weight kg.	Package cm	€ sat/TRANSPARENT	€ sat/COLOURED
<b>AP1511.1L</b>	Ø24 - P11 - H24 cm	LED 1 x 12,8W	1,135	2,085	31 x 31 x 32	<b>390,00</b>	<b>431,00</b>
<b>APGIG1511.1L</b>	Ø36 - P13 - H36 cm	LED 1 x 12,8W	1,735	2,935	41 x 41 x 32	<b>639,00</b>	■ <b>752,00</b> ■ <b>FUME (08) +10%</b>

CEILING LAMP

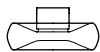

CODE	Dimensions	LED	Net weight kg.	Gross weight kg.	Package cm	€ sat/TRANSPARENT	€ sat/COLOURED
<b>1516.1L</b>	Ø24 - H11 cm	LED 1 x 17,4W	1,135	2,085	31 x 31 x 32	<b>390,00</b>	<b>431,00</b>
<b>GIG1516.1L</b>	Ø36 - H13 cm	LED 1 x 17,4W	1,735	2,935	41 x 41 x 32	<b>639,00</b>	■ <b>752,00</b> ■ <b>FUME (08) +10%</b>

HANGING LAMP

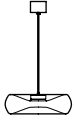

CODE	Glass	LED	H cable cm	Net weight kg.	Gross weight kg.	Package cm	€ sat/TRANSPARENT	€ sat/COLOURED
<b>1513.1L</b>	Ø24 - H7 cm	LED 1 x 17,4W	150 cm	1,235	2,185	31 x 31 x 32	<b>382,00</b>	<b>423,00</b>
<b>GIG1513.1L</b>	Ø36 - H10 cm	LED 1 x 17,4W	150 cm	1,835	3,035	41 x 41 x 32	<b>617,00</b>	■ <b>739,00</b> ■ <b>FUME (08) +10%</b>

TRACK  
standard composition

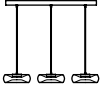

CODE	Dimensions	LED	H cable cm	Net weight kg.	Gross weight kg.	Package cm	€ sat/TRANSPARENT	€ sat/COLOURED
<b>1517.120.3L</b> (3x glass)	L124 - P24 - H150 cm	LED 3 x 17,4W	150 cm	4,590	7,830	<b>3X</b> 31 x 31 x 32 / 13 x 10 x 130	<b>1.316,00</b>	<b>1.439,00</b>
TRACK: POLISHED STAINLESS STEEL								

HANGING LAMP  
without canopy

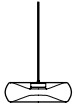

CODE without canopy for compositions	LED	H cable cm	Net weight kg.	Gross weight kg.	Package cm	€ sat/TRANSPARENT	€ sat/COLOURED	
<b>1513</b>	Ø24 - H7 cm	LED 1 x 17,4W	150 cm	1,235	2,185	31 x 31 x 32	<b>360,00</b>	<b>401,00</b>
<b>GIG1513</b>	Ø36 - H10 cm	LED 1 x 17,4W	150 cm	1,835	3,035	41 x 41 x 42	<b>595,00</b>	■ <b>717,00</b> ■ <b>FUME (08) +10%</b>



USE THE PRICES WITHOUT CANOPY STARTING FROM PAGE 62 TO PAGE 75 TO CREATE **CUSTOM COMPOSITIONS**

# FREQUENCY<sup>©</sup><sup>®</sup> EUIPO's registered community design



FINITURA METALLICA DISPONIBILE METAL FINISH AVAILABLE

Cromo / Oro satinato / Nichel nero satinato Chrome / Satin gold / Satin black nickel

- STRUTTURA IN OTTONE GALVANIZZATO / STRUCTURE IN GALVANIZED BRASS
- DRIVER INCLUSO / DRIVER INCLUDED
- A RICHIESTA: **CON COMPONENTI UL** per USA **+10%** / ON DEMAND: **WITH UL COMPONENTS** for USA **+10%**

LED DISPONIBILE PER LA LINEA FREQUENCY<sup>®</sup> / LED AVAILABLE FOR FREQUENCY<sup>®</sup>:  
LED 26,1W - 1700 Lm - 700mA - CRI 95 - 37V

I LUMEN INDICATI CORRISPONDONO ALL'INTENSITÀ LUMINOSA ALL'ORIGINE DELLA SCHEDA LED  
LUMEN INDICATED CORRESPONDS TO THE LUMINOUS INTENSITY AT THE ORIGIN OF THE LED BOARD

HANGING LAMP

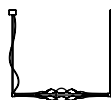

CODE	Glass	LED	H cable cm	Net weight kg.	Gross weight kg.	Package cm	€ TRANSPARENT	€ bicolored SHINY-TOBACCO
1553.OR	L128 - P17 - H17 cm	LED 26,1W	200 cm	2,750	4,950	136 x 22 x 26	2.855,00	3.283,00

HANGING LAMP



CODE	Glass	LED	H cable cm	Net weight kg.	Gross weight kg.	Package cm	€ TRANSPARENT	€ bicolored SHINY-TOBACCO
1553.VE	L17 - P17 - H128 cm	LED 26,1W	200 cm	2,750	4,950	136 x 22 x 26	2.855,00	3.283,00

# GEO<sup>®</sup>

## FINITURA METALLICA STANDARD STANDARD FINISH AVAILABLE

Cromo / Bianco opaco / Nero opaco / Cromo spazzolato Chrome / Matt white / Matt black / Brushed chrome

## FINITURA GALVANICA A RICHIESTA GALVANIC FINISH ON DEMAND

- STRUTTURA E ROSONE SINGOLO DISPONIBILE IN: Oro satinato / Bronzo satinato / Nichel nero satinato **+29,00 Euro**  
 STRUCTURE AND SMALL SINGLE CANOPY: Satin gold / Satin bronze / Satin black nickel **+29,00 Euro**

- STRUTTURA PORTALAMPADA IN ALLUMINIO / ALUMINUM LAMP HOLDER 

- CAVO ELETTRICO COASSIALE A BASSA TENSIONE TRASPARENTE O NERO  
 COAXIAL LOW VOLTAGE ELECTRIC CABLE IN TRANSPARENT OR BLACK

- DRIVER INCLUSO / DRIVER INCLUDED

- DIMMERABILE: SÌ - SCHEDA LED SOSTITUIBILE DA PROFESSIONISTA  
 DIMMABLE: YES - LED IS REPLACEABLE BY PROFESSIONAL

- ARTICOLI GIG E XXL NEL COLORE **FUMÈ**: SUPPLEMENTO DEL **10% SUL PREZZO DEL COLORATO** ■  
 PRODUCTS GIG AND XXL IN **FUME COLOR**: **10% SURCHARGE ON THE PRICE OF THE COLOURED**

- A RICHIESTA: **CON COMPONENTI UL** per USA **+10%** / ON DEMAND: **WITH UL COMPONENTS** for USA **+10%**

LED DISPONIBILI PER LA LINEA GEO<sup>®</sup> / LEDS AVAILABLE FOR GEO<sup>®</sup>:

LED 1 x 6W DIMM - 11,2-12,8 V - 500 mA - CRI >90 - 866 Lm - 144 Lm/W - 3 Step MacAdam - **2700°K**

LED 1 x 6W DIMM - 11,2-12,8 V - 500 mA - CRI >90 - 866 Lm - 144 Lm/W - 3 Step MacAdam - **3000°K**

I LUMEN INDICATI CORRISPONDONO ALL'INTENSITÀ LUMINOSA ALL'ORIGINE DELLA SCHEDA LED  
 LUMEN INDICATED CORRESPONDS TO THE LUMINOUS INTENSITY AT THE ORIGIN OF THE LED BOARD

**A RICHIESTA: GLI ARTICOLI SI POSSONO RICHIEDERE CON LED DA 8,4W CON UN SUPPLEMENTO DI +70,00 Euro**

**ON DEMAND: PRODUCTS CAN BE REQUIRED WITH 8,4W LED WITH A SURCHARGE OF +70.00 Euro**

CODE	Glass	LED	H cable cm	Net weight kg.	Gross weight kg.	Package cm	€ TRANSPARENT	€ COLOURED
1543.1L	Ø26 - H18 cm	LED 1 x 6W	200 cm	0,900	1,900	29 x 29 x 57	325,00	405,00
GIG1543.1L	Ø30 - H20 cm	LED 1 x 6W	200 cm	1,100	2,300	41 x 41 x 42	356,00	■ 444,00
XXL1543.1L	Ø34 - H24 cm	LED 1 x 6W	200 cm	2,400	4,300	43 x 43 x 54	435,00	■ 537,00

■ **FUME (08) +10%**



TRACK  
standard composition

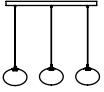

CODE	Glass	LED	H cable cm	Net weight kg.	Gross weight kg.	Package cm	€ TRANSPARENT	€ COLOURED
<b>1547.120.3L</b>	L126 - P26 - H150 cm	LED 3 x 6W	200 cm	3,760	5,780	130 x 13 x 10 / <b>3X</b> 29 x 29 x 57	<b>1.145,00</b>	<b>1.385,00</b>
TRACK: POLISHED STAINLESS STEEL								

CEILING LAMP  
standard composition

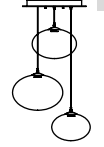

CODE	Glass	LED	H cable cm	Net weight kg.	Gross weight kg.	Package cm	€ TRANSPARENT	€ COLOURED
<b>1549MX.43.3L</b>	Ø57 - H150 cm	LED 3 x 6W	200 cm	6,820	9,200	50 x 50 x 12 / 29 x 29 x 47 / 41 x 41 x 42 / 43 x 43 x 54	<b>1.309,00</b>	■ <b>1.579,00</b> ■ <b><u>FUME (08) +10%</u></b>
PLATE: POLISHED STAINLESS STEEL								

HANGING LAMP  
without canopy



CODE without canopy for compositions	LED	H cable cm	Net weight kg.	Gross weight kg.	Package cm	€ TRANSPARENT	€ COLOURED
<b>1543</b>	LED 1 x 6W	200 cm	0,900	1,900	29 x 29 x 57	<b>303,00</b>	<b>383,00</b>
<b>GIG1543</b>	LED 1 x 6W	200 cm	1,100	2,300	41 x 41 x 42	<b>334,00</b>	■ <b>422,00</b>
<b>XXL1543</b>	LED 1 x 6W	200 cm	2,400	4,300	43 x 43 x 54	<b>413,00</b>	■ <b>515,00</b> ■ <b><u>FUME (08) +10%</u></b>



USE THE PRICES WITHOUT CANOPY STARTING FROM PAGE 62 TO PAGE 75 TO CREATE **CUSTOM COMPOSITIONS**

# LACRIMA<sup>©</sup> smooth glass

FINITURA METALLICA DISPONIBILE METAL FINISH AVAILABLE

Cromo Chrome

- CAVO TRASPARENTE / TRANSPARENT CABLE
- ARTICOLI GIG NEL COLORE **FUMÈ**: SUPPLEMENTO DEL **10% SUL PREZZO DEL COLORATO** ■  
PRODUCTS GIG AND IN **FUME** COLOR: **10% SURCHARGE ON THE PRICE OF THE COLOURED**
- A RICHIESTA: SOSPENSIONE G9 PUÒ ESSERE REALIZZATA CON ATTACCO E14, senza sovrapprezzo  
ON DEMAND: HANGING LAMPS WITH G9 CAN BE MADE WITH E14, without surcharge
- A RICHIESTA: SOSPENSIONE E14 PUÒ ESSERE REALIZZATA CON ATTACCO E27, senza sovrapprezzo  
ON DEMAND: HANGING LAMPS WITH E14 CAN BE MADE WITH E27, without surcharge
- PARALUMI DISPONIBILI PER LAMPADE DA TAVOLO: PONGÈ AVORIO CON GRECA BASSA / PONGÈ AVORIO CON GRECA ALTA  
AVAILABLE FABRIC SHADES FOR TABLE LAMPS: IVORY PONGÈ WITH LOW TRIMMING / IVORY PONGÈ WITH HIGH TRIMMING

HANGING LAMP



CODE	Glass	Bulb	H cable cm	Net weight kg.	Gross weight kg.	Package cm	€ TRANSPARENT	€ COLOURED
<b>MINI1253.1L</b>	Ø13 - H26 cm	G9 1 x max 42W	150 cm	0,480	1,100	55 x 21 x 19	<b>206,00</b>	<b>246,00</b>
<b>1253.1L</b>	Ø18 - H32 cm	E14 1 x max 40W	150 cm	0,820	1,800	26 x 26 x 47	<b>248,00</b>	<b>297,00</b>
<b>GIG1253.1L</b>	Ø26 - H42 cm	E27 1 x max 70W	150 cm	1,085	2,100	29 x 29 x 57	<b>368,00</b>	■ <b>442,00</b> ■ <b>FUME (08) +10%</b>

HANGING LAMP  
standard composition

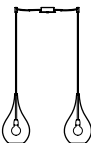

CODE	Glass	Bulb	H cable cm	Net weight kg.	Gross weight kg.	Package cm	€ TRANSPARENT	€ COLOURED
<b>MINI1253.2L (2x glass)</b>	2x Ø13 - H26 cm	G9 2x max 42W	250 cm	0,800	1,800	55 x 21 x 19	<b>439,00</b>	<b>519,00</b>
<b>MINI1253.3L (3x glass)</b>	3x Ø13 - H26 cm	G9 3x max 42W	250 cm	1,390	2,100	41 x 41 x 42	<b>646,00</b>	<b>766,00</b>
<b>1253.2L (2x glass)</b>	2x Ø18 - H32 cm	E14 2 x max 40W	250 cm	1,540	3,200	41 x 42 x 42	<b>523,00</b>	<b>621,00</b>



TRACK  
standard composition

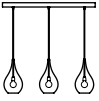

CODE	Dimensions	Bulb	H cable cm	Net weight kg.	Gross weight kg.	Package cm	€ TRANSPARENT	€ COLOURED
<b>1257.120.3L</b> (3x glass)	L120 - P18 - H150 cm	E14 3 x max 40W	150 cm	3,400	6,250	43 x 43 x 54 / 10 x 13 x 130	<b>914,00</b>	<b>1.061,00</b>
TRACK: POLISHED STAINLESS STEEL								

CEILING LAMP  
standard composition

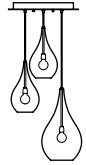

CODE	Dimensions	Bulb	H cable cm	Net weight kg.	Gross weight kg.	Package cm	€ TRANSPARENT	€ COLOURED
<b>1259MX.3L</b>	Ø48 - H150 cm	E27 1 x max 70W E14 2 x max 40W	150 cm	4,600	7,400	43 x 43 x 54 / 50 x 50 x 12	<b>1.057,00</b>	■ <b>1.229,00</b> ■ <b>FUME (08) +10%</b>
PLATE: POLISHED STAINLESS STEEL								

HANGING LAMP  
without canopy

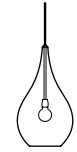

CODE without canopy for compositions	Bulb	H cable cm	Net weight kg.	Gross weight kg.	Package cm	€ TRANSPARENT	€ COLOURED
<b>MINI1253</b>	G9 1 x max 42W	150 cm	0,480	1,100	55 x 21 x 19	<b>184,00</b>	<b>224,00</b>
<b>1253</b>	E14 1 x max 40W	150 cm	0,820	1,800	26 x 26 x 47	<b>226,00</b>	<b>275,00</b>
<b>GIG1253</b>	E27 1 x max 70W	150 cm	1,085	2,100	29 x 29 x 57	<b>346,00</b>	■ <b>420,00</b> ■ <b>FUME (08) +10%</b>



USE THE PRICES WITHOUT CANOPY STARTING FROM PAGE 62 TO PAGE 75 TO CREATE **CUSTOM COMPOSITIONS**

# LACRIMA<sup>©</sup> ribbed glass

FINITURA METALLICA DISPONIBILE METAL FINISH AVAILABLE

Cromo Chrome

- CAVO TRASPARENTE / TRANSPARENT CABLE

- ARTICOLI GIG NEL COLORE **FUMÈ**: SUPPLEMENTO DEL **10% SUL PREZZO DEL COLORATO** ■  
 PRODUCTS GIG AND IN **FUME** COLOR: **10% SURCHARGE ON THE PRICE OF THE COLOURED**

- A RICHIESTA: SOSPENSIONE G9 PUÒ ESSERE REALIZZATA CON ATTACCO E14, senza sovrapprezzo  
 ON DEMAND: HANGING LAMPS WITH G9 CAN BE MADE WITH E14, without surcharge

- A RICHIESTA: SOSPENSIONE E14 PUÒ ESSERE REALIZZATA CON ATTACCO E27, senza sovrapprezzo  
 ON DEMAND: HANGING LAMPS WITH E14 CAN BE MADE WITH E27, without surcharge

- PARALUMI DISPONIBILI PER LAMPADE DA TAVOLO: PONGÈ AVORIO CON GRECA BASSA / PONGÈ AVORIO CON GRECA ALTA  
 AVAILABLE FABRIC SHADES FOR TABLE LAMPS: IVORY PONGÈ WITH LOW TRIMMING / IVORY PONGÈ WITH HIGH TRIMMING

TABLE LAMP



CODE	Dimensions	Bulb	Net weight kg. Gross weight kg.		Package cm	€ TRANSPARENT	€ COLOURED
<b>RLU1250</b>	Ø30 - H55 cm	E14 1 x max 40W	0,970	1,970	43 x 43 x 54	<b>302,00</b>	<b>362,00</b>
<b>RLUGIG1250</b>	Ø40 - H70 cm	E27 1 x max 60W	1,480	2,480	43 x 43 x 64	<b>516,00</b>	■ <b>591,00</b>

■ **FUME (08) +10%**

HANGING LAMP



CODE	Glass	Bulb	H cable cm	Net weight kg. Gross weight kg.		Package cm	€ TRANSPARENT	€ COLOURED
<b>RMINI1253.1L</b>	Ø13 - H26 cm	G9 1 x max 42W	150 cm	0,480	1,100	55 x 21 x 19	<b>225,00</b>	<b>270,00</b>
<b>R1253.1L</b>	Ø18 - H32 cm	E14 1 x max 40W	150 cm	0,820	1,800	26 x 26 x 47	<b>272,00</b>	<b>325,00</b>
<b>RGIG1253.1L</b>	Ø26 - H42 cm	E27 1 x max 70W	150 cm	1,085	2,100	29 x 29 x 57	<b>403,00</b>	■ <b>482,00</b>

■ **FUME (08) +10%**

HANGING LAMP  
standard composition

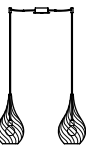

CODE	Glass	Bulb	H cable cm	Net weight kg. Gross weight kg.		Package cm	€ TRANSPARENT	€ COLOURED
<b>RMINI1253.2L</b> (2x glass)	2x Ø13 - H26 cm	G9 2x max 42W	250 cm	0,800	1,800	55 x 21 x 19	<b>477,00</b>	<b>567,00</b>
<b>RMINI1253.3L</b> (3x glass)	3x Ø13 - H26 cm	G9 3x max 42W	250 cm	1,390	2,100	41 x 41 x 42	<b>703,00</b>	<b>838,00</b>
<b>R1253.2L</b> (2x glass)	2x Ø18 - H32 cm	E14 2 x max 40W	250 cm	1,540	3,200	41 x 42 x 42	<b>571,00</b>	<b>677,00</b>

TRACK  
standard composition

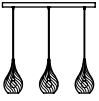

CODE	Dimensions	Bulb	H cable cm	Net weight kg.	Gross weight kg.	Package cm	€ TRANSPARENT	€ COLOURED
<b>R1257.120.3L</b> (3x glass)	L120- P18 - H150 cm	E14 3 x max 40W	150 cm	3,400	6,250	43 x 43 x 54 / 10 x 13 x 130	<b>986,00</b>	<b>1.145,00</b>
TRACK: POLISHED STAINLESS STEEL								

CEILING LAMP  
standard composition



CODE	Dimensions	Bulb	H cable cm	Net weight kg.	Gross weight kg.	Package cm	€ TRANSPARENT	€ COLOURED
<b>R1259MX.3L</b>	Ø48 - H150 cm	E27 1 x max 70W E14 2 x max 40W	150 cm	4,600	7,400	43 x 43 x 54 / 50 x 50 x 12	<b>1.140,00</b>	■ <b>1.325,00</b> ■ <b><u>FUME (08) +10%</u></b>
PLATE: POLISHED STAINLESS STEEL								

HANGING LAMP  
without canopy



CODE without canopy for compositions	Bulb	H cable cm	Net weight kg.	Gross weight kg.	Package cm	€ TRANSPARENT	€ COLOURED
<b>RMINI1253</b>	G9 1 x max 42W	150 cm	0,480	1,100	55 x 21 x 19	<b>203,00</b>	<b>248,00</b>
<b>R1253</b>	E14 1 x max 40W	150 cm	0,820	1,800	26 x 26 x 47	<b>250,00</b>	<b>303,00</b>
<b>RGIG1253</b>	E27 1 x max 70W	150 cm	1,085	2,100	29 x 29 x 57	<b>381,00</b>	■ <b>460,00</b> ■ <b><u>FUME (08) +10%</u></b>



USE THE PRICES WITHOUT CANOPY STARTING FROM PAGE 62 TO PAGE 75 TO CREATE **CUSTOM COMPOSITIONS**

# LADY LOUIS<sup>©</sup><sup>®</sup> EUIPO's registered community design

FINITURA METALLICA DISPONIBILE METAL FINISH AVAILABLE

Cromo / Nero Chrome / Black

- CAVO ELETTRICO DISPONIBILE: TRASPARENTE O IN GOMMA NERO  
ELECTRIC CABLE AVAILABLE: TRANSPARENT OR BLACK RUBBER
- DIFFUSORE IN VETRO SABBIAATO / GLASS DIFFUSER IN SANDED GLASS
- ARTICOLI GIG E XXL NEL COLORE **FUMÈ**: SUPPLEMENTO DEL **10% SUL PREZZO DEL COLORATO** ■  
PRODUCTS GIG AND XXL IN **FUME COLOR**: **10% SURCHARGE ON THE PRICE OF THE COLOURED**

HANGING LAMP



CODE	Glass	Bulb	H cable cm	Net weight kg.	Gross weight kg.	Package cm	€ sat/TRANSPARENT	€ sat/COLOURED	€ sat/METAL BRONZE GLASS
<b>1473.1L</b>	Ø20 - H42 cm	G9 1 x max 42W	150 cm	0,530	1,630	29 x 29 x 57	<b>221,00</b>	<b>265,00</b>	<b>344,00</b>
<b>GIG1473.1L</b>	Ø30 - H57 cm	E27 1 x max 70W	150 cm	1,200	2,810	39 x 39 x 67	<b>405,00</b>	■ <b>484,00</b>	<b>559,00</b>
<b>XXL1473.1L</b>	Ø37 - H59 cm	E27 1 x max 70W	150 cm	1,640	3,440	43 x 43 x 64	<b>539,00</b>	■ <b>639,00</b>	<b>790,00</b>

■ **FUME (08) +10%**

HANGING LAMP  
standard composition



CODE	Glass	Bulb	H cable cm	Net weight kg.	Gross weight kg.	Package cm	€ sat/TRANSPARENT	€ sat/COLOURED	€ sat/METAL BRONZE GLASS
<b>1473.3L</b> (3x glass)	3x Ø20 - H42 cm	G9 3 x max 42W	250 cm	1,590	4,890	<b>3X</b> 29 x 29 x 57	<b>694,00</b>	<b>826,00</b>	<b>1.063,00</b>
<b>1475.3L</b> (3x glass)	3x Ø20 - H42 cm	G9 3 x max 42W	250 cm	1,650	4,950	<b>3X</b> 29 x 29 x 57	<b>ON DEMAND</b>	<b>ON DEMAND</b>	<b>ON DEMAND</b>

TRACK  
standard composition

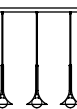

CODE	Dimensions	Bulb	H cable cm	Net weight kg.	Gross weight kg.	Package cm	€ sat/TRANSPARENT	€ sat/COLOURED	€ sat/METAL BRONZE GLASS
<b>1477.120.3L</b> (3x glass)	L120 - P20 - H150 cm	G9 3 x max 42W	150 cm	3,080	6,170	<b>3X</b> 29 x 29 x 57 / 10 x 10 x 140	<b>833,00</b>	<b>965,00</b>	<b>1.202,00</b>

TRACK: POLISHED STAINLESS STEEL

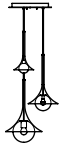

CODE	Dimensions	Bulb	H cable cm	Net weight kg.	Gross weight kg.	Package cm	€ sat/TRANSPARENT	€ sat/COLOURED	€ sat/METAL BRONZE GLASS
<b>1479MX.43.3L</b>	Ø55 - H150 cm	G9 1 x max 42W E27 2 x max 70W	150 cm	5,460	9,370	29 x 29 x 57 / 39 x 39 x 67 / 43 x 43 x 64 / 20 x 50 x 50	<b>1.358,00</b>	■ <b>1.581,00</b> ■ <b>FUME (08) +10%</b>	<b>1.886,00</b>
PLATE: POLISHED STAINLESS STEEL									



CODE without canopy for compositions	Dimensions	Bulb	H cable cm	Net weight kg.	Gross weight kg.	Package cm	€ sat/TRANSPARENT	€ sat/COLOURED	€ sat/METAL BRONZE GLASS
<b>1473</b>	Ø20 - H42 cm	G9 1 x max 42W	150 cm	0,530	1,630	29 x 29 x 57	<b>199,00</b>	<b>243,00</b>	<b>322,00</b>
<b>GIG1473</b>	Ø30 - H57 cm	E27 1 x max 70W	150 cm	1,200	2,810	39 x 39 x 67	<b>383,00</b>	■ <b>462,00</b>	<b>537,00</b>
<b>XXL1473</b>	Ø37 - H59 cm	E27 1 x max 70W	150 cm	1,640	3,440	43 x 43 x 64	<b>517,00</b>	■ <b>617,00</b> ■ <b>FUME (08) +10%</b>	<b>768,00</b>



USE THE PRICES WITHOUT CANOPY STARTING FROM PAGE 62 TO PAGE 75 TO CREATE **CUSTOM COMPOSITIONS**

# MIREA<sup>©</sup>

FINITURA METALLICA DISPONIBILE METAL FINISH AVAILABLE

Oro satinato / Bronzo satinato / Nichel nero satinato Satin gold / Satin bronze / Satin black nickel

- STRUTTURA IN OTTONE GALVANIZZATO / STRUCTURE IN GALVANIZED BRASS

- A RICHIESTA: IL LAMPADARIO PUÒ ESSERE REALIZZATO CON ALTEZZA PERSONALIZZATA (allungando l'elemento fisso fra l'ingombro ed il rosone)  
ON DEMAND: THE CHANDELIER CAN BE MADE WITH CUSTOMIZED HEIGHT (lengthening the metal pipe between the chandelier and the canopy)

TABLE LAMP



CODE	Dimensions	Bulb	Net weight kg. Gross weight kg.		Package cm	€ TRANSPARENT	€ COLOURED
<b>LU1570.1L</b>	Ø18 - H21 cm	G9 1 x max 33W	0,800	1,600	26 x 26 x 37	<b>224,00</b>	<b>269,00</b>

WALL LAMP

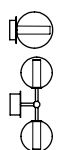

CODE	Dimensions	Bulb	Net weight kg. Gross weight kg.		Package cm	€ TRANSPARENT	€ COLOURED
<b>AP1571.14.1L</b>	L14 - P17 - H14 cm	G9 1 x max 33W	0,400	0,800	38 x 18 x 19	<b>203,00</b>	<b>231,00</b>
<b>AP1571.18.1L</b>	L18 - P21 - H18 cm	G9 1 x max 33W	0,500	1,300	26 x 26 x 37	<b>214,00</b>	<b>256,00</b>
<b>AP1571.2L (2x glass)</b>	L12 - P16 - H37 cm	G9 2 x max 33W	0,700	1,300	55 x 21 x 19	<b>302,00</b>	<b>362,00</b>

CEILING LAMP



CODE	Dimensions	Bulb	Net weight kg. Gross weight kg.		Package cm	€ TRANSPARENT	€ COLOURED
<b>1576.14.1L</b>	Ø14 - H17 cm	G9 1 x max 33W	0,400	0,800	38 x 18 x 19	<b>203,00</b>	<b>231,00</b>
<b>1576.18.1L</b>	Ø18 - H21 cm	G9 1 x max 33W	0,500	1,300	26 x 26 x 37	<b>214,00</b>	<b>256,00</b>

HANGING LAMP

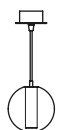

CODE	Glass	Bulb	Net weight kg. Gross weight kg.		Package cm	€ TRANSPARENT	€ COLOURED
<b>1573.14.1L</b>	Ø14	G9 1 x max 33W	0,450	0,850	38 x 18 x 19	<b>225,00</b>	<b>253,00</b>
<b>1573.18.1L</b>	Ø18	G9 1 x max 33W	0,550	1,350	26 x 26 x 37	<b>236,00</b>	<b>278,00</b>

CHANDELIER

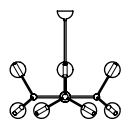

CODE	Dimensions	Bulb	Net weight kg. Gross weight kg.		Package cm	€ TRANSPARENT	€ COLOURED
<b>1574.9L (9x glass)</b>	Ø93 - H83 cm	G9 9 x max 33W	4,500	10,000	81 x 81 x 62	<b>1.642,00</b>	<b>1.848,00</b>
<b>1574.12L (12x glass)</b>	Ø93 - H83 cm	G9 12 x max 33W	6,000	11,600	81 x 81 x 62	<b>2.049,00</b>	<b>2.324,00</b>
<b>1574.9+3/12L (12x glass)</b>	Ø105 - H83 cm	G9 12 x max 33W	5,200	13,000	81 x 81 x 62	<b>1.979,00</b>	<b>2.253,00</b>
<b>1574.12+4/16L (16x glass)</b>	Ø105 - H83 cm	G9 16 x max 33W	7,100	13,500	81 x 81 x 62	<b>2.556,00</b>	<b>2.922,00</b>
<b>1574.10L (10x glass)</b>	L115 - P57 - H85 cm	G9 10 x max 33W	4,900	12,500	101 x 101 x 60	<b>1.767,00</b>	<b>1.996,00</b>

# PARIGI<sup>©</sup> CIPOLLA smooth glass

FINITURA METALLICA DISPONIBILE METAL FINISH AVAILABLE

Cromo Chrome

- CAVO TRASPARENTE / TRANSPARENT CABLE

- ARTICOLI GIG E XXL NEL COLORE **FUMÈ**: SUPPLEMENTO DEL **10% SUL PREZZO DEL COLORATO** ■  
 PRODUCTS GIG AND XXL IN **FUME COLOR**: **10% SURCHARGE ON THE PRICE OF THE COLOURED**

- PARALUMI IN LINO OLANDA DISPONIBILI PER LAMPADE DA TAVOLO: BIANCO, PANNA, TORTORA  
 AVAILABLE "LINO OLANDA" FABRIC SHADES FOR TABLE LAMPS: WHITE, CREAM, DOVE GRAY

TABLE LAMP



CODE	Dimensions	Bulb	Net weight kg. Gross weight kg.		Package cm	€ TRANSPARENT	€ COLOURED
LU1213	Ø16 - H30 cm	E14 1 x max 40W	0,520	1,000	26 x 26 x 47	276,00	330,00
LUGIG1213	Ø30 - H53 cm	E27 1 x max 60W	1,650	3,700	2X 41 x 41 x 42	453,00	■ 538,00
LUXXL1213	Ø38 - H63 cm	E27 1 x max 60W	2,640	6,200	41 x 41 x 42 / 43 x 43 x 64	720,00	■ 848,00 ■ <b>FUME (08) +10%</b>

WALL LAMP



CODE	Dimensions	Bulb	Net weight kg. Gross weight kg.		Package cm	€ TRANSPARENT	€ COLOURED
AP1211.1L	L15 - P19 - H23 cm	E14 1 x max 40W	0,450	0,900	38 x 18 x 19	195,00	233,00

HANGING LAMP

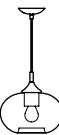

CODE	Glass	Bulb	H cable cm	Net weight kg. Gross weight kg.		Package cm	€ TRANSPARENT	€ COLOURED
1213.1L	Ø16 - H12 cm	E14 1 x max 40W	150 cm	0,450	0,900	38 x 18 x 19	175,00	211,00
MED1213.1L	Ø22 - H15 cm	E27 1 x max 70W	150 cm	1,100	2,100	31 x 31x 32	261,00	314,00
GIG1213.1L	Ø30 - H19 cm	E27 1 x max 70W	150 cm	1,400	2,500	41 x 41 x 42	308,00	■ 367,00
XXL1213.1L	Ø38 - H25 cm	E27 1 x max 70W	150 cm	2,400	4,200	41 x 41 x 42	586,00	■ 700,00 ■ <b>FUME (08) +10%</b>

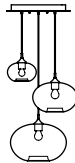

CODE	Dimensions	Bulb	H cable cm	Net weight kg.	Gross weight kg.	Package cm	€ TRANSPARENT	€ COLOURED
<b>1219MX.3L</b> PLATE: POLISHED STAINLESS STEEL	Ø60 - H150 cm	E14 1 x max 40W E27 2 x max 70W	150 cm	6,440	11,000	2X 41 x 41 x 42 / 50 x 50 x 12	<b>1.262,00</b>	■ <b>1.471,00</b> ■ <b>FUME (08) +10%</b>

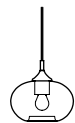

CODE without canopy for compositions	Dimensions	Bulb	H cable cm	Net weight kg.	Gross weight kg.	Package cm	€ TRANSPARENT	€ COLOURED
<b>1213</b>	Ø16 - H12 cm	E14 1 x max 40W	150 cm	0,450	0,900	38 x 18 x 19	<b>153,00</b>	<b>189,00</b>
<b>MED1213</b>	Ø22 - H15 cm	E27 1 x max 70W	150 cm	1,100	2,100	31 x 31x 32	<b>239,00</b>	<b>292,00</b>
<b>GIG1213</b>	Ø30 - H19 cm	E27 1 x max 70W	150 cm	1,400	2,500	41 x 41 x 42	<b>286,00</b>	■ <b>345,00</b>
<b>XXL1213</b>	Ø38 - H25 cm	E27 1 x max 70W	150 cm	2,400	4,200	41 x 41 x 42	<b>564,00</b>	■ <b>678,00</b> ■ <b>FUME (08) +10%</b>



USE THE PRICES WITHOUT CANOPY STARTING FROM PAGE 62 TO PAGE 75 TO CREATE **CUSTOM COMPOSITIONS**



# PARIGI<sup>©</sup> CIPOLLA ribbed glass

FINITURA METALLICA DISPONIBILE METAL FINISH AVAILABLE

Cromo Chrome

- CAVO TRASPARENTE / TRANSPARENT CABLE

- ARTICOLI GIG E XXL NEL COLORE **FUMÈ**: SUPPLEMENTO DEL **10% SUL PREZZO DEL COLORATO** ■  
 PRODUCTS GIG AND XXL IN **FUME COLOR**: **10% SURCHARGE ON THE PRICE OF THE COLOURED**

- PARALUMI IN LINO OLANDA DISPONIBILI PER LAMPADE DA TAVOLO: BIANCO, PANNA, TORTORA  
 AVAILABLE "LINO OLANDA" FABRIC SHADES FOR TABLE LAMPS: WHITE, CREAM, DOVE GRAY

TABLE LAMP



CODE	Dimensions	Bulb	Net weight kg. Gross weight kg.		Package cm	€ TRANSPARENT	€ COLOURED
<b>RLU1213</b>	Ø16 - H30 cm	E14 1 x max 40W	0,520	1,000	26 x 26 x 47	<b>304,00</b>	<b>362,00</b>
<b>RLUGIG1213</b>	Ø30 - H53 cm	E27 1 x max 60W	1,650	3,700	<b>2X</b> 41 x 41 x 42	<b>498,00</b>	■ <b>591,00</b>
<b>RLUXXL1213</b>	Ø38 - H63 cm	E27 1 x max 60W	2,640	6,200	41 x 41 x 42 / 43 x 43 x 64	<b>793,00</b>	■ <b>933,00</b> ■ <b>FUME (08) +10%</b>

WALL LAMP



CODE	Dimensions	Bulb	Net weight kg. Gross weight kg.		Package cm	€ TRANSPARENT	€ COLOURED
<b>RAP1211.1L</b>	L15 - P19 - H23 cm	E14 1 x max 40W	0,450	0,900	38 x 18 x 19	<b>214,00</b>	<b>256,00</b>

HANGING LAMP

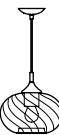

CODE	Glass	Bulb	H cable cm	Net weight kg. Gross weight kg.		Package cm	€ TRANSPARENT	€ COLOURED
<b>R1213.1L</b>	Ø16 - H12 cm	E14 1 x max 40W	150 cm	0,450	0,900	38 x 18 x 19	<b>193,00</b>	<b>230,00</b>
<b>RMED1213.1L</b>	Ø22 - H15 cm	E27 1 x max 70W	150 cm	1,100	2,100	31 x 31x 32	<b>288,00</b>	<b>344,00</b>
<b>RGIG1213.1L</b>	Ø30 - H19 cm	E27 1 x max 70W	150 cm	1,400	2,500	41 x 41 x 42	<b>340,00</b>	■ <b>403,00</b>
<b>RXXL1213.1L</b>	Ø38 - H25 cm	E27 1 x max 70W	150 cm	2,400	4,200	41 x 41 x 42	<b>644,00</b>	■ <b>768,00</b> ■ <b>FUME (08) +10%</b>



CODE	Dimensions	Bulb	H cable cm	Net weight kg.	Gross weight kg.	Package cm	€ TRANSPARENT	€ COLOURED
<b>R1219MX.3L</b> PLATE: POLISHED STAINLESS STEEL	Ø60 - H150 cm	E14 1 x max 40W E27 2 x max 70W	150 cm	6,440	11,000	2X 41 x 41 x 42 / 50 x 50 x 12	<b>1.370,00</b>	■ <b>1.594,00</b> ■ <b>FUME (08) +10%</b>



CODE without canopy for compositions	Bulb	H cable cm	Net weight kg.	Gross weight kg.	Package cm	€ TRANSPARENT	€ COLOURED	
<b>R1213</b>	Ø16 - H12 cm	E14 1 x max 40W	150 cm	0,450	0,900	38 x 18 x 19	<b>171,00</b>	<b>208,00</b>
<b>RMED1213</b>	Ø22 - H15 cm	E27 1 x max 70W	150 cm	1,100	2,100	31 x 31x 32	<b>266,00</b>	<b>322,00</b>
<b>RGIG1213</b>	Ø30 - H19 cm	E27 1 x max 70W	150 cm	1,400	2,500	41 x 41 x 42	<b>318,00</b>	■ <b>381,00</b>
<b>RXXL1213</b>	Ø38 - H25 cm	E27 1 x max 70W	150 cm	2,400	4,200	41 x 41 x 42	<b>622,00</b>	■ <b>746,00</b> ■ <b>FUME (08) +10%</b>



USE THE PRICES WITHOUT CANOPY STARTING FROM PAGE 62 TO PAGE 75 TO CREATE **CUSTOM COMPOSITIONS**

# PARIGI<sup>©</sup> PALLA smooth glass

FINITURA METALLICA DISPONIBILE METAL FINISH AVAILABLE

Cromo Chrome

- CAVO TRASPARENTE / TRANSPARENT CABLE

- ARTICOLI GIG E XXL NEL COLORE FUMÈ: SUPPLEMENTO DEL 10% SUL PREZZO DEL COLORATO ■  
PRODUCTS GIG AND XXL IN FUME COLOR: 10% SURCHARGE ON THE PRICE OF THE COLOURED

- PARALUMI IN LINO OLANDA DISPONIBILI PER LAMPADE DA TAVOLO: BIANCO, PANNA, TORTORA  
AVAILABLE "LINO OLANDA" FABRIC SHADES FOR TABLE LAMPS: WHITE, CREAM, DOVE GRAY

TABLE LAMP



CODE	Dimensions	Bulb	Net weight kg. Gross weight kg.		Package cm	€ TRANSPARENT	€ COLOURED
LU1203	Ø16 - H34 cm	E14 1 x max 40W	0,520	1,000	26 x 26 x 47	276,00	330,00
LUGIG1203	Ø28 - H58 cm	E27 1 x max 60W	1,700	3,700	2X 41 x 41 x 42	453,00	■ 538,00
LUXXL1203	Ø38 - H78 cm	E27 1 x max 60W	2,700	6,200	43 x 43 x 54 / 43 x 43 x 64	810,00	■ 965,00 ■ <u>FUME (08) +10%</u>

WALL LAMP



CODE	Dimensions	Bulb	Net weight kg. Gross weight kg.		Package cm	€ TRANSPARENT	€ COLOURED
AP1201.1L	L15 - P19 - H25 cm	E14 1 x max 40W	0,490	0,900	38 x 18 x 19	195,00	233,00

HANGING LAMP

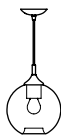

CODE	Glass	Bulb	H cable cm	Net weight kg. Gross weight kg.		Package cm	€ TRANSPARENT	€ COLOURED
1203.1L	Ø16 cm	E14 1 x max 40W	150 cm	0,490	0,900	38 x 18 x 19	175,00	211,00
MED1203.1L	Ø22 cm	E27 1 x max 70W	150 cm	1,200	2,200	31 x 31x 32	261,00	314,00
GIG1203.1L	Ø28 cm	E27 1 x max 70W	150 cm	1,500	2,500	41 x 41 x 42	308,00	■ 367,00
XXL1203.1L	Ø38 cm	E27 1 x max 70W	150 cm	2,400	4,300	43 x 43 x 54	640,00	■ 774,00 ■ <u>FUME (08) +10%</u>

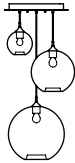

CODE	Dimensions	Bulb	H cable cm	Net weight kg.	Gross weight kg.	Package cm	€ TRANSPARENT	€ COLOURED
<b>1209MX.3L</b> PLATE: POLISHED STAINLESS STEEL	Ø60 - H150 cm	E14 1 x max 40W E27 2 x max 70W	150 cm	6,940	11,000	43 x 43 x 54 / 41 x 41 x 42 / 50 x 50 x 12	<b>1.316,00</b>	■ <b>1.545,00</b> ■ <b>FUME (08) +10%</b>

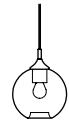

CODE without canopy for compositions	Dimensions	Bulb	H cable cm	Net weight kg.	Gross weight kg.	Package cm	€ TRANSPARENT	€ COLOURED
<b>1203</b>	Ø16 cm	E14 1 x max 40W	150 cm	0,490	0,900	38 x 18 x 19	<b>153,00</b>	<b>189,00</b>
<b>MED1203</b>	Ø22 cm	E27 1 x max 70W	150 cm	1,200	2,200	31 x 31x 32	<b>239,00</b>	<b>292,00</b>
<b>GIG1203</b>	Ø28 cm	E27 1 x max 70W	150 cm	1,500	2,500	41 x 41 x 42	<b>286,00</b>	■ <b>345,00</b>
<b>XXL1203</b>	Ø38 cm	E27 1 x max 70W	150 cm	2,400	4,300	43 x 43 x 54	<b>618,00</b>	■ <b>752,00</b> ■ <b>FUME (08) +10%</b>



USE THE PRICES WITHOUT CANOPY STARTING FROM PAGE 62 TO PAGE 75 TO CREATE **CUSTOM COMPOSITIONS**

# PARIGI<sup>©</sup> PALLA ribbed glass

FINITURA METALLICA DISPONIBILE METAL FINISH AVAILABLE

Cromo Chrome

- CAVO TRASPARENTE / TRANSPARENT CABLE

- ARTICOLI GIG E XXL NEL COLORE **FUMÈ**: SUPPLEMENTO DEL **10% SUL PREZZO DEL COLORATO** ■  
 PRODUCTS GIG AND XXL IN **FUME COLOR**: **10% SURCHARGE ON THE PRICE OF THE COLOURED**

- PARALUMI IN LINO OLANDA DISPONIBILI PER LAMPADE DA TAVOLO: BIANCO, PANNA, TORTORA  
 AVAILABLE "LINO OLANDA" FABRIC SHADES FOR TABLE LAMPS: WHITE, CREAM, DOVE GRAY

TABLE LAMP



CODE	Dimensions	Bulb	Net weight kg. Gross weight kg.		Package cm	€ TRANSPARENT	€ COLOURED
RLU1203	Ø16 - H34 cm	E14 1 x max 40W	0,520	1,000	26 x 26 x 47	304,00	362,00
RLUGIG1203	Ø28 - H58 cm	E27 1 x max 60W	1,700	3,700	2X 41 x 41 x 42	498,00	■ 591,00
RLUXXL1203	Ø38 - H78 cm	E27 1 x max 60W	2,700	6,200	43 x 43 x 54 / 43 x 43 x 64	891,00	■ 1.062,00 ■ <b>FUME (08) +10%</b>

WALL LAMP



CODE	Dimensions	Bulb	Net weight kg. Gross weight kg.		Package cm	€ TRANSPARENT	€ COLOURED
RAP1201.1L	L15 - P19 - H25 cm	E14 1 x max 40W	0,490	0,900	38 x 18 x 19	214,00	256,00

HANGING LAMP



CODE	Glass	Bulb	H cable cm	Net weight kg. Gross weight kg.		Package cm	€ TRANSPARENT	€ COLOURED
R1203.1L	Ø16 cm	E14 1 x max 40W	150 cm	0,490	0,900	38 x 18 x 19	193,00	230,00
RMED1203.1L	Ø22 cm	E27 1 x max 70W	150 cm	1,200	2,200	31 x 31x 32	288,00	344,00
RGIG1203.1L	Ø28 cm	E27 1 x max 70W	150 cm	1,500	2,500	41 x 41 x 42	340,00	■ 403,00
RXXL1203.1L	Ø38 cm	E27 1 x max 70W	150 cm	2,400	4,300	43 x 43 x 54	705,00	■ 852,00 ■ <b>FUME (08) +10%</b>

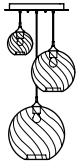

CODE	Dimensions	Bulb	H cable cm	Net weight kg.	Gross weight kg.	Package cm	€ TRANSPARENT	€ COLOURED
<b>R1209MX.3L</b> PLATE: POLISHED STAINLESS STEEL	Ø60 - H150 cm	E14 1 x max 40W E27 2 x max 70W	150 cm	6,940	11,000	43 x 43 x 54 / 41 x 41 x 42 / 50 x 50 x 12	<b>1.431,00</b>	■ <b>1.678,00</b> ■ <b>FUME (08) +10%</b>



CODE without canopy for compositions	Bulb	H cable cm	Net weight kg.	Gross weight kg.	Package cm	€ TRANSPARENT	€ COLOURED	
<b>R1203</b>	Ø16 cm	E14 1 x max 40W	150 cm	0,490	0,900	38 x 18 x 19	<b>171,00</b>	<b>208,00</b>
<b>RMED1203</b>	Ø22 cm	E27 1 x max 70W	150 cm	1,200	2,200	31 x 31x 32	<b>266,00</b>	<b>322,00</b>
<b>RGIG1203</b>	Ø28 cm	E27 1 x max 70W	150 cm	1,500	2,500	41 x 41 x 42	<b>318,00</b>	■ <b>381,00</b>
<b>RXXL1203</b>	Ø38 cm	E27 1 x max 70W	150 cm	2,400	4,300	43 x 43 x 54	<b>683,00</b>	■ <b>830,00</b> ■ <b>FUME (08) +10%</b>



USE THE PRICES WITHOUT CANOPY STARTING FROM PAGE 62 TO PAGE 75 TO CREATE **CUSTOM COMPOSITIONS**

**FINITURA METALLICA STANDARD** STANDARD FINISH AVAILABLE

**Cromo / Bianco opaco / Nero opaco / Cromo spazzolato** Chrome / Matt white / Matt black / Brushed chrome

**FINITURA GALVANICA A RICHIESTA** GALVANIC FINISH ON DEMAND

- STRUTTURA E ROSONE SINGOLO DISPONIBILE IN: Oro satinato / Bronzo satinato / Nichel nero satinato **+29,00 Euro**  
STRUCTURE AND SMALL SINGLE CANOPY: Satin gold / Satin bronze / Satin black nickel **+29,00 Euro**
- BINARI E PIASTRE DISPONIBILI SOLO IN: Cromo / Bianco opaco / Nero opaco / Cromo spazzolato  
TRACKS AND PLATES AVAILABLE ONLY IN: Chrome / Matt white / Matt black / Brushed chrome

- STRUTTURA PORTALAMPADA IN ALLUMINIO / ALUMINUM LAMP HOLDER
- CAVO ELETTRICO COASSIALE A BASSA TENSIONE TRASPARENTE O NERO  
COAXIAL LOW VOLTAGE ELECTRIC CABLE IN TRANSPARENT OR BLACK
- DRIVER INCLUSO / DRIVER INCLUDED
- DIMMERABILE: SÌ - SCHEDA LED SOSTITUIBILE DA PROFESSIONISTA  
DIMMABLE: YES - LED IS REPLACEABLE BY PROFESSIONAL
- ARTICOLI GIG XXL E MAX NEL COLORE **FUMÈ**: SUPPLEMENTO DEL **10% SUL PREZZO DEL COLORATO** ■  
PRODUCTS GIG XXL AND MAX IN **FUME** COLOR: **10% SURCHARGE ON THE PRICE OF THE COLOURED**
- A RICHIESTA: **CON COMPONENTI UL** per USA **+10%** / ON DEMAND: **WITH UL COMPONENTS** for USA **+10%**

LED DISPONIBILI PER LA LINEA PIT® / LEDS AVAILABLE FOR PIT®:

LED 1 x 6W DIMM - 11,2-12,8 V - 500 mA - CRI >90 - 866 Lm - 144 Lm/W - 3 Step MacAdam - **2700°K**  
LED 1 x 6W DIMM - 11,2-12,8 V - 500 mA - CRI >90 - 866 Lm - 144 Lm/W - 3 Step MacAdam - **3000°K**

LED DISPONIBILE PER LA LINEA PIT® **PIANTANA** / LED AVAILABLE FOR PIT® **FLOOR LAMP**:

LED 1 x 8,4W DIMM - 11,2-12,8 V - 700mA - CRI >90 - 1200 Lm - 144 Lm/W - 3 Step MacAdam - **2700°K**  
LED 1 x 8,4W DIMM - 11,2-12,8 V - 700mA - CRI >90 - 1200 Lm - 144 Lm/W - 3 Step MacAdam - **3000°K**

LED DISPONIBILE PER LA LINEA PIT® **MAX1583** / LED AVAILABLE FOR PIT® CODE **MAX1583**:

LED 1 x 8,4W DIMM - 22,4-24,8 V - 350 mA - CRI >90 - 1202 Lm - 144 Lm/W - 3 Step MacAdam - **2700°K**  
LED 1 x 8,4W DIMM - 22,4-24,8 V - 350 mA - CRI >90 - 1202 Lm - 144 Lm/W - 3 Step MacAdam - **3000°K**

I LUMEN INDICATI CORRISPONDONO ALL'INTENSITÀ LUMINOSA ALL'ORIGINE DELLA SCHEDA LED  
LUMEN INDICATED CORRESPONDS TO THE LUMINOUS INTENSITY AT THE ORIGIN OF THE LED BOARD



**FINITURA METALLICA PER LUMETTO E PIANTANA DISPONIBILI SOLO IN:**  
Oro satinato / Bronzo satinato / Nichel nero satinato (senza sovrapprezzo)  
**METAL FINISH FOR TABLE AND FLOOR LAMP AVAILABLE ONLY IN:**  
Satin gold / Satin bronze / Satin black nickel (without surcharge)

**A RICHIESTA:** ARTICOLI GIG1583 E XXL1583 SI POSSONO RICHIEDERE CON LED DA **8,4W** CON UN SUPPLEMENTO DI **+70,00 Euro**

**ON DEMAND:** PRODUCTS GIG1583 AND XXL1583 CAN BE REQUIRED WITH **8,4W** LED WITH A SURCHARGE OF **+70,00 Euro**



CODE	Dimensions	LED	Net weight kg.	Gross weight kg.	Package cm	€ TRANSPARENT	€ COLOURED
<b>LU1585.1L</b>	Ø30 - H175 cm	LED 1 x 8,4W with dimmer push button	5,300	9,700	181 x 31 x 17 / 41 x 41 x 42	<b>895,00</b>	■ <b>999,00</b> ■ <b>FUME (08) +10%</b>

TABLE LAMP



CODE	Dimensions	LED	Net weight kg. Gross weight kg.		Package cm	€ TRANSPARENT	€ COLOURED
<b>LU1580.1L</b>	Ø22 - H50 cm	LED 1 x 6W with dimmer push button	1,800	2,600	26 x 26 x 37 / 38 x 18 x 19	<b>458,00</b>	<b>515,00</b>

HANGING LAMP



CODE	Glass	LED	H cable cm	Net weight kg. Gross weight kg.		Package cm	€ TRANSPARENT	€ COLOURED
<b>1583.1L</b>	Ø22 cm	LED 1 x 6W	200 cm	0,750	1,500	26 x 26 x 47	<b>251,00</b>	<b>312,00</b>
<b>GIG1583.1L</b>	Ø26 cm	LED 1 x 6W	200 cm	0,900	1,900	29 x 29 x 57	<b>274,00</b>	■ <b>341,00</b>
<b>XXL1583.1L</b>	Ø30 cm	LED 1 x 6W	200 cm	1,100	2,300	41 x 41 x 42	<b>334,00</b>	■ <b>412,00</b>
<b>MAX1583.1L</b>	Ø36 cm	LED 1 x 8,4W	200 cm	2,400	4,300	43 x 43 x 54	<b>630,00</b>	■ <b>756,00</b>

■ **FUME (08) +10%**

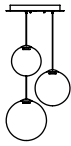
CEILING LAMP  
standard composition

CODE	Dimensions	LED	H cable cm	Net weight kg. Gross weight kg.		Package cm	€ TRANSPARENT	€ COLOURED
<b>1589MX.43.3L</b> (3x glass)	Ø52 - H150 cm	LED 3 x 6W	200 cm	4,800	8,500	50 x 50 x 12 / 26 x 26 x 37 / 29 x 29 x 47 / 41 x 41 x 42	<b>1.052,00</b>	■ <b>1.258,00</b>

PLATE: POLISHED STAINLESS STEEL

■ **FUME (08) +10%**

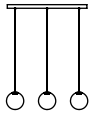
TRACK  
standard composition

CODE	Dimensions	LED	H cable cm	Net weight kg. Gross weight kg.		Package cm	€ TRANSPARENT	€ COLOURED
<b>1587.120.3L</b> (3x glass)	L120 - P22 - H150 cm	LED 3 x 6W	200 cm	3,500	5,500	130 x 13 x 10 / 3X 26 x 26 x 47	<b>923,00</b>	<b>1.106,00</b>

TRACK: POLISHED STAINLESS STEEL

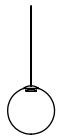
HANGING LAMP  
without canopy

CODE without canopy for compositions	LED	H cable cm	Net weight kg. Gross weight kg.		Package cm	€ TRANSPARENT	€ COLOURED
<b>1583</b>	LED 1 x 6W	200 cm	0,750	1,500	26 x 26 x 47	<b>229,00</b>	<b>290,00</b>
<b>GIG1583</b>	LED 1 x 6W	200 cm	0,900	1,900	29 x 29 x 57	<b>252,00</b>	■ <b>319,00</b>
<b>XXL1583</b>	LED 1 x 6W	200 cm	1,100	2,300	41 x 41 x 42	<b>312,00</b>	■ <b>390,00</b>
<b>MAX1583</b>	LED 1 x 8,4W	200 cm	2,400	4,300	43 x 43 x 54	<b>608,00</b>	■ <b>743,00</b>

■ **FUME (08) +10%**



USE THE PRICES WITHOUT CANOPY STARTING FROM PAGE 62 TO PAGE 75 TO CREATE **CUSTOM COMPOSITIONS**



# SCARLETT<sup>©</sup>

FINITURA METALLICA DISPONIBILE METAL FINISH AVAILABLE

Ottone spazzolato (01) / Bronzo spazzolato (02) *Brushed brass (01) / Brushed bronze (02)*

- STRUTTURA METALLICA IN OTTONE / BRASS METAL STRUCTURE

- A RICHIESTA: IL LAMPADARIO PUÒ ESSERE REALIZZATO CON ALTEZZA PERSONALIZZATA (allungando l'elemento fisso fra l'ingombro ed il rosone)  
ON DEMAND: THE CHANDELIER CAN BE MADE WITH CUSTOMIZED HEIGHT (lengthening the metal pipe between the chandelier and the canopy)

WALL LAMP



CODE	Dimensions	Bulb	Net weight kg.	Gross weight kg.	Package cm	€ TRANSPARENT	€ COLOURED / satin WHITE
<b>AP1491.1L</b>	L14 - P21- H30 cm	E14 1 x max 40W	0,580	1,580	55 x 21 x 19	<b>210,00</b>	<b>230,00</b>

CHANDELIER

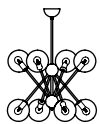

CODE	Dimensions	Bulb	Net weight kg.	Gross weight kg.	Package cm	€ TRANSPARENT	€ COLOURED / satin WHITE
<b>1493.4+4/8L</b> (8x glass)	Ø60 - H72 cm	E14 8 x max 40W	3,700	6,700	60 x 60 x 60	<b>1.195,00</b>	<b>1.314,00</b>
<b>1493.6+6/12L</b> (12x glass)	Ø80 - H98 cm	E14 12 x max 40W	6,500	11,500	71 x 71 x 76	<b>1.870,00</b>	<b>2.055,00</b>
<b>1493.8+8/16L</b> (16x glass)	Ø102 - H114 cm	E14 16 x max 40W	8,200	14,200	100 x 100 x 90	<b>2.531,00</b>	<b>2.784,00</b>

FINITURA METALLICA DISPONIBILE METAL FINISH AVAILABLE

Cromo Chrome

- ARTICOLI GIG NEL COLORE FUMÈ: SUPPLEMENTO DEL 10% SUL PREZZO DEL COLORATO ■  
 PRODUCTS GIG IN FUME COLOR: 10% SURCHARGE ON THE PRICE OF THE COLOURED

HANGING LAMP

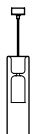

CODE	Glass	Bulb	H cable cm	Net weight kg.	Gross weight kg.	Package cm	€ TRANSPARENT	€ COLOURED	€ METALLIC GLASS
1383.1L	Ø8 - H30 cm	G9 1 x max 33W	150 cm	0,800	1,300	55 x 21 x 19	226,00	267,00	339,00
GIG1383.1L	Ø10 - H37 cm	E27 1 x max 70W	150 cm	1,500	2,200	26 x 26 x 46	348,00	■ 395,00 ■ FUME (08) +10%	478,00

HANGING LAMP  
standard composition

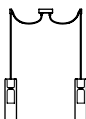

CODE	Glass	Bulb	H cable cm	Net weight kg.	Gross weight kg.	Package cm	€ TRANSPARENT	€ COLOURED	€ METALLIC GLASS
1383.2L (2x glass)	2x Ø8 - H30 cm	G9 2 x max 33W	250 cm	1,500	2,600	2X 55 x 21 x 19	481,00	563,00	707,00
GIG1383.2L (2x glass)	2x Ø10 - H37 cm	E27 2 x max 70W	250 cm	3,200	4,200	2X 26 x 26 x 47	725,00	■ 819,00 ■ FUME (08) +10%	985,00

HANGING LAMP  
standard composition

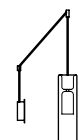

CODE	Glass	Bulb	H cable cm	Net weight kg.	Gross weight kg.	Package cm	€ TRANSPARENT	€ COLOURED	€ METALLIC GLASS
1385.1L	Ø8 - H30 cm	G9 1 x max 33W	250 cm	0,900	1,400	55 x 21 x 19	ON DEMAND	ON DEMAND	ON DEMAND
1385.3L (3x glass)	3x Ø8 - H30 cm	G9 3 x max 33W	250 cm	2,400	4,100	61 x 26 x 29	ON DEMAND	ON DEMAND	ON DEMAND

TRACK  
standard composition



CODE	Dimensions	Bulb	H cable cm	Net weight kg.	Gross weight kg.	Package cm	€ TRANSPARENT	€ COLOURED	€ METALLIC GLASS
<b>1387.7L</b> (7x glass)	L110 - P8 - H150 cm	G9 7 x max 33W	150 cm	6,930	9,000	20 x 20 x 120 / 43 x 43 x 54	<b>1.608,00</b>	<b>1.895,00</b>	<b>2.399,00</b>
<b>GIG1387.3L</b> (3x glass)	L70 - P10 - H150 cm	E27 3 x max 70W	150 cm	6,900	9,100	43 x 43 x 54 / 20 x 20 x 100	<b>1.120,00</b>	■ <b>1.261,00</b>	<b>1.510,00</b>

TRACK: POLISHED STAINLESS STEEL

■ **FUME (08) +10%**

CEILING LAMP  
standard composition

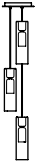

CODE	Dimensions	Bulb	H cable cm	Net weight kg.	Gross weight kg.	Package cm	€ TRANSPARENT	€ COLOURED	€ METALLIC GLASS
<b>1389.6L</b> (6x glass)	Ø27 - H150 cm	G9 6 x max 33W	150 cm	5,245	8,000	20 x 50 x 12 / 41 x 41 x 42	<b>1.427,00</b>	<b>1.673,00</b>	<b>2.105,00</b>
<b>GIG1389.3L</b> (3x glass)	Ø27 - H150 cm	E27 3 x max 70W	150 cm	5,600	6,800	50 x 50 x 12 / 43 x 43 x 54	<b>1.181,00</b>	■ <b>1.322,00</b>	<b>1.571,00</b>

PLATE: POLISHED STAINLESS STEEL

■ **FUME (08) +10%**

HANGING LAMP  
without canopy

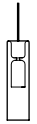

CODE without canopy for compositions	Bulb	H cable cm	Net weight kg.	Gross weight kg.	Package cm	€ TRANSPARENT	€ COLOURED	€ METALLIC GLASS	
<b>1383</b>	Ø8 - H30 cm	G9 1 x max 33W	150 cm	0,800	1,300	55 x 21 x 19	<b>204,00</b>	<b>245,00</b>	<b>317,00</b>
<b>GIG1383</b>	Ø10 - H37 cm	E27 1 x max 70W	150 cm	1,500	2,200	26 x 26 x 46	<b>326,00</b>	■ <b>373,00</b>	<b>456,00</b>

■ **FUME (08) +10%**



USE THE PRICES WITHOUT CANOPY STARTING FROM PAGE 62 TO PAGE 75 TO CREATE **CUSTOM COMPOSITIONS**

FINITURA METALLICA DISPONIBILE METAL FINISH AVAILABLE

Cromo / Bianco opaco / Nero opaco / Cromo spazzolato Chrome / Matt white / Matt black / Brushed chrome

- CAVO TRASPARENTE, A RICHIESTA: TESSILE NERO  
TRANSPARENT CABLE, ON DEMAND: BLACK TEXTILE

- ARTICOLI GIG XXL E MAX NEL COLORE FUMÈ: SUPPLEMENTO DEL 10% SUL PREZZO DEL COLORATO ■  
PRODUCTS GIG XXL AND MAX IN FUME COLOR: 10% SURCHARGE ON THE PRICE OF THE COLOURED

- A RICHIESTA: SOSPENSIONE E APPLIQUE G9 PUÒ ESSERE REALIZZATA CON ATTACCO E14, senza sovrapprezzo  
ON DEMAND: HANGING LAMPS AND WALL LAMPS WITH G9 CAN BE MADE WITH E14, without surcharge

LED DISPONIBILE PER LAMPADRE DA TAVOLO CON PARALUME / LED AVAILABLE FOR TABLE LAMPS WITH SHADE:  
LED 4,3W 350 LUMEN 3.000K

I LUMEN INDICATI CORRISPONDONO ALL'INTENSITÀ LUMINOSA ALL'ORIGINE DELLA SCHEDA LED  
LUMEN INDICATED CORRESPONDS TO THE LUMINOUS INTENSITY AT THE ORIGIN OF THE LED BOARD

CODE	Dimensions	Bulb	Net weight kg.	Gross weight kg.	Package cm	€ TRANSPARENT	€ COLOURED	€ METALLIC GLASS
<b>LU1300</b>	Ø16 - H33 cm	G9 1 x max 33W	0,800	1,700	26 x 26 x 47	<b>388,00</b>	<b>460,00</b>	<b>492,00</b>
<b>LUGIG1300</b>	Ø22 - H43 cm	E27 1 x max 60W	1,620	2,500	29 x 29 x 57	<b>541,00</b>	■ <b>657,00</b>	<b>700,00</b>
<b>LUXXL1300</b>	Ø30 - H58 cm	E27 1 x max 60W	2,780	4,300	39 x 39 x 67	<b>859,00</b>	■ <b>1.044,00</b>	<b>1.074,00</b>
							■ <b>FUME (08) +10%</b>	

CODE	Dimensions	Bulb	Net weight kg.	Gross weight kg.	Package cm	€ TRANSPARENT	€ COLOURED	€ METALLIC GLASS
<b>LU1303</b>	Ø25 - H43 cm	E14 1 x max 40W LED 1 x 4,3W 350 LUMEN 3.000K	1,100	2,000	29 x 29 x 57	<b>504,00</b>	<b>578,00</b>	<b>607,00</b>
<b>LUGIG1303</b>	Ø40 - H58 cm	E27 1 x max 60W LED 1 x 4,3W 350 LUMEN 3.000K	1,920	3,800	29 x 29 x 57 / 41 x 41 x 32	<b>739,00</b>	■ <b>851,00</b>	<b>897,00</b>
<b>LUXXL1303</b>	Ø50 - H78 cm	E27 1 x max 60W LED 1 x 4,3W 350 LUMEN 3.000K	3,435	6,500	39 x 39 x 67 / 51 x 51 x 50	<b>1.092,00</b>	■ <b>1.276,00</b>	<b>1.307,00</b>
							■ <b>FUME (08) +10%</b>	

TABLE LAMP



TABLE LAMP

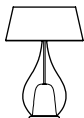

WALL LAMP



CODE	Dimensions	Bulb	H cable cm	Net weight kg.	Gross weight kg.	Package cm	€ TRANSPARENT	€ COLOURED	€ METALLIC GLASS
<b>AP1301.1L</b>	L16 - P20 cm	G9 1 x max 33W	50 cm	0,875	1,300	26 x 26 x 47	<b>310,00</b>	<b>383,00</b>	<b>413,00</b>

HANGING LAMP

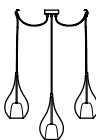

CODE	Glass	Bulb	H cable cm	Net weight kg.	Gross weight kg.	Package cm	€ TRANSPARENT	€ COLOURED	€ METALLIC GLASS
<b>1303.1L</b>	Ø16 - H28 cm	G9 1 x max 48W	150 cm	0,790	1,300	26 x 26 x 47	<b>300,00</b>	<b>372,00</b>	<b>404,00</b>
<b>GIG1303.1L</b>	Ø22 - H38 cm	E27 1 x max 105W	150 cm	1,510	2,400	29 x 29 x 57	<b>441,00</b>	■ <b>553,00</b>	<b>600,00</b>
<b>XXL1303.1L</b>	Ø30 - H53 cm	E27 1 x max 105W	150 cm	2,500	4,300	39 x 39 x 67	<b>743,00</b>	■ <b>927,00</b>	<b>956,00</b>

■ **FUME (08) +10%**HANGING LAMP  
standard composition

CODE	Glass	Bulb	H cable cm	Net weight kg.	Gross weight kg.	Package cm	€ TRANSPARENT	€ COLOURED	€ METALLIC GLASS
<b>1303.2L</b> (2x glass)	2x Ø16 - H28 cm	G9 2 x max 48W	250 cm	1,530	2,500	<b>2X</b> 26 x 26 x 47	<b>627,00</b>	<b>771,00</b>	<b>835,00</b>
<b>1303.3L</b> (3x glass)	3x Ø16 - H28 cm	G9 3 x max 48W	250 cm	2,250	3,600	41 x 41 x 42	<b>928,00</b>	<b>1.144,00</b>	<b>1.240,00</b>

TRACK  
standard composition

CODE	Dimensions	Bulb	H cable cm	Net weight kg.	Gross weight kg.	Package cm	€ TRANSPARENT	€ COLOURED	€ METALLIC GLASS
<b>1307.3L</b> (3x glass)	L100-P16-H150 cm	G9 3 x max 48W	150 cm	2,900	5,600	41 x 41 x 42 / 10 x 10 x 120	<b>976,00</b>	<b>1.192,00</b>	<b>1.288,00</b>
<b>GIG1307.120.3L</b> (3x glass)	L120-P22-H150 cm	E27 3 x max 105W	150 cm	5,590	9,400	10 x 13 x 130 / <b>3X</b> 29 x 29 x 57	<b>1.493,00</b>	■ <b>1.829,00</b>	<b>1.970,00</b>

TRACK: POLISHED STAINLESS STEEL

■ **FUME (08) +10%**CEILING LAMP  
standard composition

CODE	Dimensions	Bulb	H cable cm	Net weight kg.	Gross weight kg.	Package cm	€ TRANSPARENT	€ COLOURED	€ METALLIC GLASS
<b>1309MX.3L</b>	Ø46 - H150 cm	G9 1 x max 48W E27 2 x max 105W	150 cm	6,480	14,700	39 x 39 x 67 / 29 x 29 x 57 / 26 x 26 x 47 / 50 x 50 x 12	<b>1.677,00</b>	■ <b>2.045,00</b>	<b>2.153,00</b>

PLATE: POLISHED STAINLESS STEEL

■ **FUME (08) +10%**HANGING LAMP  
without canopy

CODE without canopy for compositions	Bulb	H cable cm	Net weight kg.	Gross weight kg.	Package cm	€ TRANSPARENT	€ COLOURED	€ METALLIC GLASS
<b>1303</b>	G9 1 x max 48W	150 cm	0,790	1,300	26 x 26 x 47	<b>278,00</b>	<b>350,00</b>	<b>382,00</b>
<b>GIG1303</b>	E27 1 x max 105W	150 cm	1,510	2,400	29 x 29 x 57	<b>419,00</b>	■ <b>531,00</b>	<b>578,00</b>
<b>XXL1303</b>	E27 1 x max 105W	150 cm	2,500	4,300	39 x 39 x 67	<b>721,00</b>	■ <b>905,00</b>	<b>934,00</b>

■ **FUME (08) +10%**USE THE PRICES WITHOUT CANOPY STARTING FROM PAGE 62 TO PAGE 75 TO CREATE **CUSTOM COMPOSITIONS**

# ZOE<sup>®</sup> MAX

FINITURA METALLICA DISPONIBILE METAL FINISH AVAILABLE

Cromo / Bianco opaco / Nero opaco / Cromo spazzolato Chrome / Matt white / Matt black / Brushed chrome

- ARTICOLO MAX NEL COLORE FUMÈ: SUPPLEMENTO DEL 10% SUL PREZZO DEL COLORATO ■  
PRODUCT MAX IN FUME COLOR: 10% SURCHARGE ON THE PRICE OF THE COLOURED



SI CONSIGLIA: LAMPADINA E27 LED 25 w 2250 lm Ø140 mm (NON INCLUSA)  
WE RECOMMEND: LED BULB E27 LED 25 w 2250 lm Ø140 mm (NOT INCLUDED)

## GUIDE TO THE METALLISATION CHARACTERISTIC

Zoe Max is a lamp made entirely by hand. The process involved in manually producing a lamp of this size is very complex and requires hours of labour performed by skilled glassblowers. On a surface of such an extent, small imperfections may occur, especially during the finishing or metallisation process. Such imperfections attest to the fact that the product is handcrafted and further increase the value of the lamp. The Cangini e Tucci company does not accept any complaints regarding micro-imperfections on the lamp surface. (Please refer to the specific brochure of reference.)

## LEITFADEN FÜR METALLISIERUNGSMERKMALE

Zoe Max ist eine vollständig von Hand gefertigte Lampe. Die handwerkliche Herstellung einer Lampe dieser Größe ist sehr komplex und erfordert stundenlange Arbeit der Glasbläser. Auf einer Oberfläche dieser Größe können kleine Unregelmäßigkeiten auftreten, insbesondere in der Endbearbeitung oder während der Metallisierung. Diese Unvollkommenheiten beweisen, dass es sich um ein handgefertigtes Produkt handelt, und erhöhen den Wert der Lampe. Die Firma Cangini e Tucci akzeptiert keine Reklamationen bezüglich oberflächlicher Mikrofehler, die die Lampe aufweisen kann. (siehe Referenzbrochure)

HANGING LAMP



CODE	Glass	Bulb	H cable cm	Net weight kg.	Gross weight kg.	Package cm	€ TRANSPARENT	€ COLOURED
<b>MAX1303.1L</b> <small>CANOPY DIAM. 120 mm</small>	Ø45 - H80 cm	E27 1 x 220-240V	150 cm	5,300	9,500	55 x 55 x 100	<b>1.410,00</b>	■ <b>1.692,00</b> ■ <b>FUME (08) +10%</b>

HANGING LAMP



CODE	Glass	Bulb	H cable cm	Net weight kg.	Gross weight kg.	Package cm	€ METAL BLACK / BRONZE	€ METAL ROSE GOLD
<b>MAX1303.1L</b> <small>CANOPY DIAM. 120 mm</small>	Ø45 - H80 cm	E27 1 x 220-240V	150 cm	5,300	9,500	55 x 55 x 100	<b>1.980,00</b>	<b>2.200,00</b>

HANGING LAMP  
without canopy



CODE without canopy for compositions	Bulb	H cable cm	Net weight kg.	Gross weight kg.	Package cm	€ TRANSPARENT	€ COLOURED
<b>MAX1303</b>	Ø45 - H80 cm	E27 1 x 220-240V	150 cm	5,300	9,500	55 x 55 x 100	<b>1.380,00</b> ■ <b>1.662,00</b> ■ <b>FUME (08) +10%</b>

HANGING LAMP  
without canopy



CODE without canopy for compositions	Bulb	H cable cm	Net weight kg.	Gross weight kg.	Package cm	€ METAL BLACK / BRONZE	€ METAL ROSE GOLD
<b>MAX1303</b>	Ø45 - H80 cm	E27 1 x 220-240V	150 cm	5,300	9,500	55 x 55 x 100	<b>1.950,00</b> <b>2.170,00</b>

- CAVO ELETTRICO IN GOMMA NERO / BLACK RUBBER ELECTRIC CABLE

LED DISPONIBILE PER LAMPADE DA TAVOLO CON PARALUME / LED AVAILABLE FOR TABLE LAMPS WITH SHADE:  
LED 4,3W 350 LUMEN 3.000K

I LUMEN INDICATI CORRISPONDONO ALL'INTENSITÀ LUMINOSA ALL'ORIGINE DELLA SCHEDA LED  
LUMEN INDICATED CORRESPONDS TO THE LUMINOUS INTENSITY AT THE ORIGIN OF THE LED BOARD

TABLE LAMP



CODE	Dimensions	Bulb	Net weight kg. Gross weight kg.		Package cm	€ TRANSPARENT	€ METALLIC sky-blue
<b>LU1520</b>	Ø25 - H43 cm	E14 1 x max 40W LED 1 x 4,3W 350 LUMEN 3.000K	1,100	2,000	29 x 29 x 57 / 28 x 28 x 18	<b>782,00</b>	<b>942,00</b>
<b>LUGIG1520</b>	Ø40 - H58 cm	E27 1 x max 60W LED 1 x 4,3W 350 LUMEN 3.000K	1,920	3,800	29 x 29 x 57 / 42 x 42 x 24	<b>1.146,00</b>	<b>1.391,00</b>
<b>LUXXL1520</b>	Ø50 - H78 cm	E27 1 x max 60W LED 1 x 4,3W 350 LUMEN 3.000K	3,435	6,500	39 x 39 x 67 / 53 x 53 x 26	<b>1.695,00</b>	<b>2.028,00</b>

WALL LAMP



CODE	Dimensions	Bulb	H cable cm	Net weight kg. Gross weight kg.		Package cm	€ METALLIC sky-blue	€ TRANSPARENT+serigraphs	€ METALLIC sky-blue +serigraphs
<b>AP1521.1L</b>	L16 - P20 cm	E14 1 x max 40W	50 cm	0,875	1,300	26 x 26 x 47	<b>640,00</b>	<b>640,00</b>	<b>698,00</b>

HANGING LAMP



CODE	Glass	Bulb	H cable cm	Net weight kg. Gross weight kg.		Package cm	€ METALLIC sky-blue	€ TRANSPARENT +serigraphs	€ METALLIC sky-blue +serigraphs
<b>1523.1L</b>	Ø16 - H28 cm	E14 1 x max 40W	150 cm	0,790	1,300	26 x 26 x 47	<b>622,00</b>	<b>622,00</b>	<b>681,00</b>
<b>GIG1523.1L</b>	Ø22 - H38 cm	E27 1 x max 105W	150 cm	1,510	2,400	29 x 29 x 57	<b>926,00</b>	<b>926,00</b>	<b>989,00</b>
<b>XXL1523.1L</b>	Ø30 - H53 cm	E27 1 x max 105W	150 cm	2,500	4,300	39 x 39 x 67	<b>1.480,00</b>	<b>1.480,00</b>	<b>1.603,00</b>

CEILING LAMP  
standard composition



CODE	Dimensions	Bulb	H cable cm	Net weight kg.	Gross weight kg.	Package cm	€ METALLIC sky-blue	€ TRANSPARENT +serigraphs	€ METALLIC sky-blue +serigraphs
<b>1529MX.3L</b>	Ø46 - H150 cm	E14 1 x max 40W E27 2 x max 105W	150 cm	6,480	14,700	39 x 39 x 67 / 29 x 29 x 57 / 26 x 26 x 47 / 50 x 50 x 12	<b>3.221,00</b>	<b>3.221,00</b>	<b>3.466,00</b>

TRACK  
standard composition

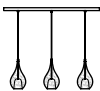

CODE	Dimensions	Bulb	H cable cm	Net weight kg.	Gross weight kg.	Package cm	€ METALLIC sky-blue	€ TRANSPARENT +serigraphs	€ METALLIC sky-blue +serigraphs
<b>1527.120.3L</b>	L100-P16-H150 cm	E14 3 x max 40W	150 cm	2,900	5,600	41 x 41 x 42 / 10 x 13 x 130	<b>2.036,00</b>	<b>2.036,00</b>	<b>2.213,00</b>
<b>GIG1527.120.3L</b>	L120-P22-H150 cm	E27 3 x max 105W	150 cm	5,590	9,400	10 x 13 x 130 / <b>3X</b> 29 x 29 x 57	<b>2.948,00</b>	<b>2.948,00</b>	<b>3.137,00</b>

HANGING LAMP  
without canopy



CODE without canopy for compositions	Bulb	H cable cm	Net weight kg.	Gross weight kg.	Package cm	€ METALLIC sky-blue	€ TRANSPARENT +serigraphs	€ METALLIC sky-blue +serigraphs	
<b>1523</b>	E14 1 x max 40W	Ø16 - H28 cm	150 cm	0,790	1,300	26 x 26 x 47	<b>600,00</b>	<b>600,00</b>	<b>659,00</b>
<b>GIG1523</b>	E27 1 x max 105W	Ø22 - H38 cm	150 cm	1,510	2,400	29 x 29 x 57	<b>904,00</b>	<b>904,00</b>	<b>967,00</b>
<b>XXL1523</b>	E27 1 x max 105W	Ø30 - H53 cm	150 cm	2,500	4,300	39 x 39 x 67	<b>1.458,00</b>	<b>1.458,00</b>	<b>1.581,00</b>



USE THE PRICES WITHOUT CANOPY STARTING FROM PAGE 62 TO PAGE 75 TO CREATE **CUSTOM COMPOSITIONS**





# GUIDE TO THE CHARACTERISTICS OF HAND-WORKED GLASS

---

## BOROSILICATE GLASS COATING PROCESS

---

Borosilicate glass is readily available in a transparent form. However, unlike with soda glass, the physical and chemical properties of molten borosilicate glass prevent it from being directly coloured with oxides or pigments. To colour borosilicate glass, known commercially as Pyrex, another method must be adopted. The procedure for achieving this result uses vacuum deposition technology called Physical Vapour Deposition (PVD). With this system, the previously treated glass is introduced into a deposition chamber specifically designed to optimize its processing according to desired specifications. A vacuum is created in this chamber to facilitate deposition on the Pyrex substrate of the desired material, which can be a metal or an oxide, or a combination of both. The minimal thickness of the deposits is such that the coating in question is called a 'thin film', consisting of nano-technological coating deposits at the nanometre scale, which, even if they are metallic, still allow the passage and diffusion of light. Therefore, glass that was previously limited to being transparent, can now assume a finish ranging from a metallic mirror to a transparent colouring effect. This process can be used to obtain various optical effects, since different deposition materials and different thicknesses of the same material will behave differently when light passes through them. In practice, the final effect is rather different from molten batch dye or paint coloured glass. The effect is instead an optical one determined by the type of material deposited and its thickness, meaning that the final product will react differently to different variations and wavelengths of light.

Direct disclosure is prohibited.  
This document provided exclusively for information on the deposition process.

# LEITFADEN ZU DEN MERKMALEN VON HANDGEFERTIGTEM GLAS

---

## COATING VERFAHREN FÜR BOROSILIKATGLAS

---

*Borosilikatglas ist in transparenter Form erhältlich. Wegen seiner chemophysikalischen Beschaffenheit ist diese Art von Glas nur in transparenter Form erhältlich und eine direkte Färbung vom geschmolzenen Glas mit Oxiden oder Pigmenten ist nicht möglich, wie man es normalerweise bei Natronglas macht. Um Borosilikatglas, im Handel auch bekannt unter dem Namen PIREX, zu färben, muss man ein anderes Verfahren anwenden. Um ein solches Resultat zu erreichen, ist eine Unter-Vakuum-Technologie, genannt PVD (Physical Vapour Deposition), das Verfahren, was man einsetzen muss. Bei diesem Verfahren wird das schon vorbehandelte Glas in entsprechende, eigens entwickelte Vakuumkammern gelegt, welche die Behandlung entsprechend den gewünschten Spezifikationen optimieren. In diesen Kammern wird ein Vakuum erzeugt. Das Vakuum ist notwendig, um auf dem Pyrex Substrat das gewünschte Material aufzutragen, welches ein Metall, ein Oxid oder eine Kombination beider sein kann. Die Dicke der Beschichtung ist dergestalt, dass man es als THIN FILM bezeichnet. Tatsächlich handelt es sich hier um Dicken im nanometrischen Bereich. Auf das Glas werden also nanotechnologische Schichten aufgetragen, was selbst bei Metallen auch noch die Diffusion von Licht zulässt, wenn dieses durch das Glas fällt. Das zuvor transparente Glas erhält nun eine Oberflächenbehandlung. Das kann reichen von einer metallischen Spiegelung bis hin zu einer transparenten Färbung. Das Charakteristische dieses Verfahrens ist es, spezielle optische Effekte zu erzielen, weil die unterschiedlichen Materialien ein unterschiedliches Lichtverhalten erzeugen; beim Lichteinfall, und bei unterschiedlichen Dicken desselben Materials resultiert dies unter und bei Lichteinfall in unterschiedlichem Materialverhalten. In der Praxis ist das Endresultat nicht dasselbe, wie bei einem mit Paste oder bei einem mittels Lack gefärbten Glas. Das Resultat ist vielmehr ein OPTISCHER Effekt, der abhängt von der Art des aufgetragenen Materials und von der Dicke dieses Materials. Aus diesem Grund wird man jeweils unterschiedliches Materialverhalten im Endprodukt haben, mit unterschiedlichem Verhalten gegenüber Licht und je nach Wellenlänge des Lichts.*

*Die direkte Verbreitung ist untersagt.  
Das Dokument ist ausschließlich bestimmt als Information zum Beschichtungsverfahren.*

## SPECKS IN THE GLASS

Small dots on the glass are to be considered part of the craftsmanship process. Despite careful quality checks of the glass, small imperfections that are initially invisible to the naked eye may emerge during blowing.



## KLEINE PUNKTE AUF DEM GLAS

*Kleine Punkte auf der Oberfläche des Glas sind merkmale der Handwerkskunst zu berücksichtigen. Trotz sorgfältiger Qualitätskontrolle des Glases könnten beim Blasen kleine Unvollkommenheiten auftreten, die für das bloße Auge zunächst unsichtbar sind.*



## “IMPERFECTIONS” IN THE GLASS

The welding and workmanship of our glass is made entirely by hand. It could happen that bubbles appear at the junction points, or more or less obvious thicknesses, which we do not consider defects, but further attest to the authenticity of the craft work.

## „UNVOLLKOMMENHEITEN“ DES GLASES

*Das Schweißen und die Verarbeitung von unseren gläsern werden ganze Handgemacht. Bläschen könnten in dem verbindungspunkt der gläsern erscheinen; mehr oder weniger unterschiedliche Dicke könnten bestehen. Wir erwägen den keinen Fehler, sondern weitere authentische zeichen vom Handwerksprozess.*



## SURFACE COLOUR

The glass tonality of the metallization is the result of an elaborate handicraft process, it is not a RAL colour, the composition is made using a special chemical process in order to obtain the mirror-smooth effect, therefore slight differences in color or different shades are inevitable.

## FARBE DER OBERFLÄCHE

Wie oben beschrieben die Glastonalität der Metallisierung ist das Ergebnis von einem aufwendiges Handwerksprozess, es ist keine RAL Farbe die Zusammensetzung erfolgt mit einem besonderen chemischer Verfahren um gleichseitig das spiegelglatt Effekt zur bekommen, die Auftragung der Beschichtung erfolgt durch eine Blitz verfahren kann keine gleichmäßige Verteilung der Farbe sein daher sind leichte Farbe unterschiede oder unterschiedlicher licht Nuancen unvermeidbar.



## METALLIZATION

Small dots, marks and optical effects (invisible when the light is off), could emerge when switched on.

## METALLISIERUNG

Kleine Punkte, Unreinheiten (unsichtbar wenn das Licht aus ist), können durch anschalten der leuchte erscheinen.





## DECOR

The decoration is made entirely by hand according to a design approved by the Van Gogh Museum and irregularities may appear in the execution.



## DEKOR

Die Dekoration wird vollständig von Hand nach einem vom Van Gogh Museum genehmigten Design hergestellt, und bei der Durchführung können Unregelmäßigkeiten auftreten.

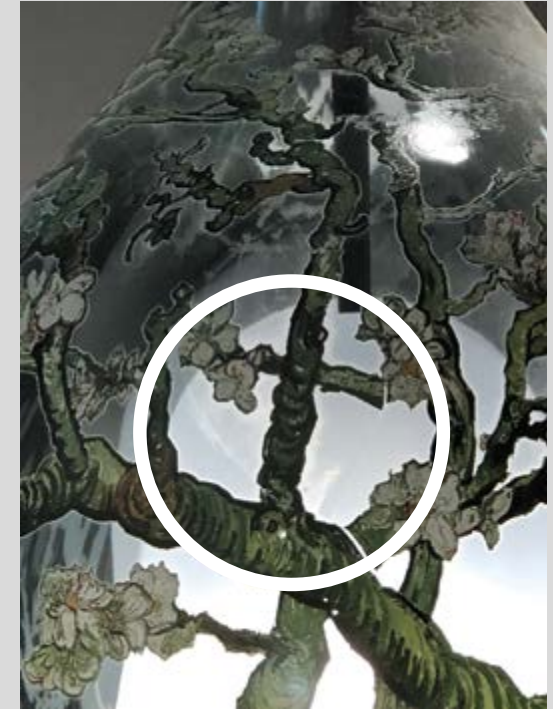

# STRUCTURES FOR COMPOSITIONS



SINGLE CANOPIES  
**63**

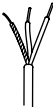

CABLES AVAILABLE  
**65**



CABLE SPACERS  
**66**



MULTIPLE CANOPIES  
**67**

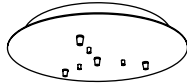

ROUND PLATES  
**68**

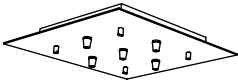

SQUARE PLATES  
**69**

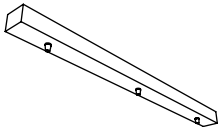

AUF TRACKS  
**70**

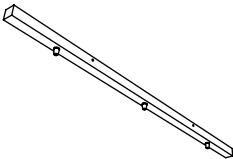

SLIM TRACKS  
**71**

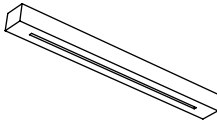

SLOT TRACKS  
**72**

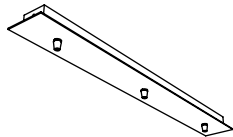

TAO TRACKS  
**73**



CUSTOM TRACKS  
**74**

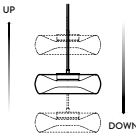









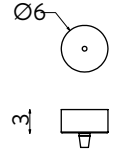

UP&DOWN SYSTEM  
**75**

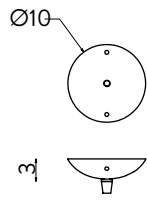

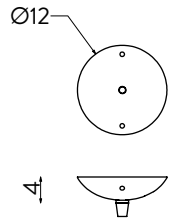
CASAMBI CONTROLLER  
**75**

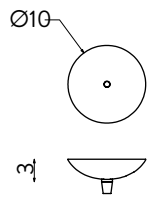

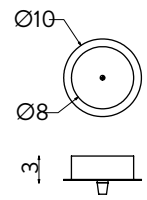



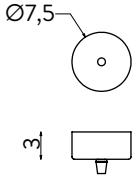

# SINGLE CANOPIES

TO CREATE A CUSTOM COMPOSITION: TAKE THE PRICES OF THE PRODUCTS WITHOUT CANOPY AND ADD THE PIECES HERE BELOW

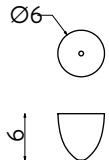
CODE	DESCRIPTION		€ CHROME / WHITE / BLACK / BRUSHED	€ GOLD/SILVER LEAF
<b>ECL6</b>	CANOPY Eclisse style DIAM.6 cm	 	22,00	+19,00
<b>LAC10</b>	CANOPY Lacrima style DIAM.10 cm	 	22,00	+19,00
<b>LAC12</b>	CANOPY Lacrima style DIAM.12 cm	 	30,00	+19,00
<b>EST10</b>	CANOPY DIAM.10 cm (without holes)	 	22,00	+19,00
<b>GOC10</b>	CANOPY DIAM.10 cm	 	25,00	+27,00

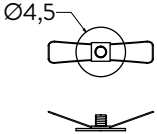
# SINGLE CANOPIES

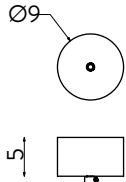



TO CREATE A CUSTOM COMPOSITION: TAKE THE PRICES OF THE PRODUCTS WITHOUT CANOPY AND ADD THE PIECES HERE BELOW

CODE	DESCRIPTION		€ CHROME / WHITE / BLACK / BRUSHED	€ GOLD/SILVER LEAF
<b>AUF7,5</b>	CANOPY Auf style DIAM. 7,5 cm	 	<b>22,00</b>	<b>+19,00</b>
<b>FL6</b>	CANOPY Flute style DIAM.6 cm	 	<b>22,00</b>	<b>+19,00</b>
<b>INC4,5</b>	RECESSED CANOPY DIAM. 4,5 cm	 	<b>30,00</b>	<b>+19,00</b>
<b>FOL9</b>	CANOPY Fold style DIAM.9 cm	 	<b>22,00</b>	<b>+19,00</b>

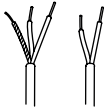

# ELECTRIC CABLES AVAILABLE

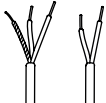
TO CREATE A CUSTOM COMPOSITION: TAKE THE PRICES OF THE PRODUCTS WITHOUT CANOPY AND ADD THE PIECES HERE BELOW

DESCRIPTION	€ EXTRA CABLE PER METER	
 TRANSPARENT SILICONE FEP BIPOLAR AND TRIPOLAR	11,00	
 COLOURED SILICONE BIPOLAR: BROWN, RED, TRANSPARENT TWISTED	11,00	
 BLACK RUBBER TRIPOLAR	11,00	
 BLACK TEXTILE TRIPOLAR OR BIPOLAR CABLE	11,00	
 TRANSPARENT OR BLACK COAXIAL CABLE	18,00	

# SPACERS for electric cables

TO CREATE A CUSTOM COMPOSITION: TAKE THE PRICES OF THE PRODUCTS WITHOUT CANOPY AND ADD THE PIECES HERE BELOW

CODE	DESCRIPTION		€ CHROME / WHITE / BLACK / BRUSHED	€ GOLD/SILVER LEAF	
WS1	GOCCIA style			12,00	+9,00
WS2	FLUTE style			13,00	+9,00
WS3	300G style			12,00	+9,00
WS4	WALL SPACER			20,00	+10,00
WS5	SPACER with base support (recommended for XXL hanging lamps)			13,00	+9,00

(on demand: the upper disc can be made with a different finish than the lower cylinder)

# CANOPIES for multiple suspensions

TO CREATE A CUSTOM COMPOSITION: TAKE THE PRICES OF THE PRODUCTS WITHOUT CANOPY AND ADD THE PIECES HERE BELOW

CODE	DESCRIPTION			€ CHROME / WHITE / BLACK / BRUSHED	€ GOLD/SILVER LEAF
<b>GOC10</b>	2/6 side HOLES (+1 central)			25,00	+27,00
<b>ECL9,5</b>	3 HOLES on the bottom (1 is central)			25,00	+21,00
<b>ECL12</b>	5 HOLES on the bottom (1 is centrale)			27,00	+21,00
<b>FL7</b>	2 side HOLES (+1 central)			22,00	+19,00
<b>FL9</b>	4 side HOLES (+1 central)			25,00	+20,00

# COMPOSITION on ROUND PLATE

TO CREATE A CUSTOM COMPOSITION: TAKE THE PRICES OF THE PRODUCTS WITHOUT CANOPY AND ADD THE PIECES HERE BELOW



FOR CUSTOMIZED PLATES CONTACT OUR TECHNICAL OFFICE AT [info@canginetucci.com](mailto:info@canginetucci.com)

CODE	DESCRIPTION	€ CHROME / WHITE / BLACK / BRUSHED	€ GOLD/SILVER LEAF
P27	<p>PLATE DIAM.27 cm (3-5-6 BULBS)</p>	203,00	+76,00
P43	<p>PLATE DIAM.43 cm (3-4-5-6-7-8-9-10-11 BULBS)</p>	259,00	+112,00
P50	<p>PLATE DIAM.50 cm (3-4-5 BULBS)</p>	356,00	+137,00

# COMPOSITION on SQUARE PLATE

TO CREATE A CUSTOM COMPOSITION: TAKE THE PRICES OF THE PRODUCTS WITHOUT CANOPY AND ADD THE PIECES HERE BELOW



FOR CUSTOMIZED PLATES CONTACT OUR TECHNICAL OFFICE AT [info@canginetucci.com](mailto:info@canginetucci.com)

CODE	DESCRIPTION	€ CHROME / WHITE / BLACK / BRUSHED	€ GOLD/SILVER LEAF
------	-------------	------------------------------------	--------------------

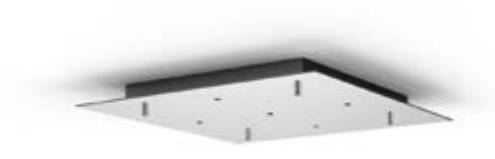

**P30X30** SQUARE PLATE 30x30 cm (5 BULBS)

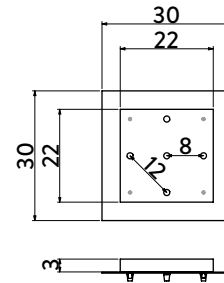

204,00

+76,00

**P40X40** SQUARE PLATE 40x40 cm (5 BULBS)

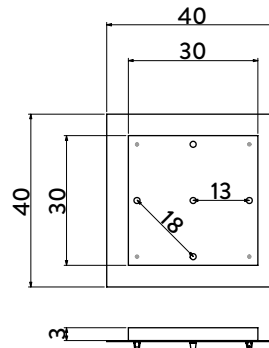

248,00

+112,00

# COMPOSITION on AUF TRACK

TO CREATE A CUSTOM COMPOSITION: TAKE THE PRICES OF THE PRODUCTS WITHOUT CANOPY AND ADD THE PIECES HERE BELOW



FOR CUSTOMIZED TRACKS CONTACT OUR TECHNICAL OFFICE AT [info@canginetucci.com](mailto:info@canginetucci.com)

CODE	DESCRIPTION	€ CHROME / WHITE / BLACK / BRUSHED	€ GOLD/SILVER LEAF
<b>AUF90</b>	TRACK 90 cm (3 BULBS)	202,00	+78,00
<b>AUF120</b>	TRACK 120 cm (3 BULBS)	236,00	+88,00
<b>AUF150</b>	TRACK 150 cm (3-5 BULBS)	276,00	+122,00

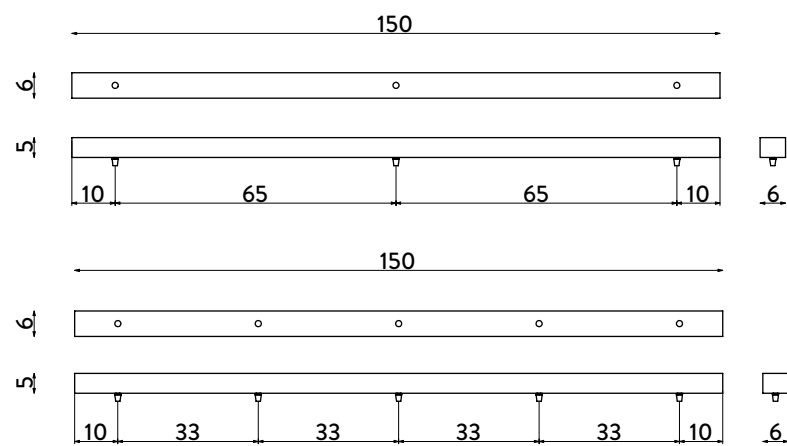
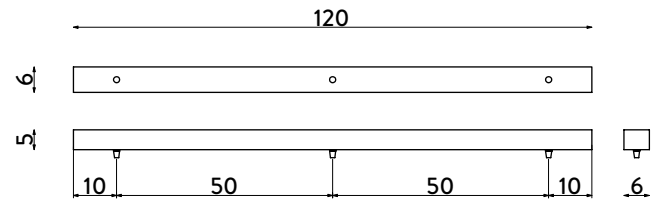
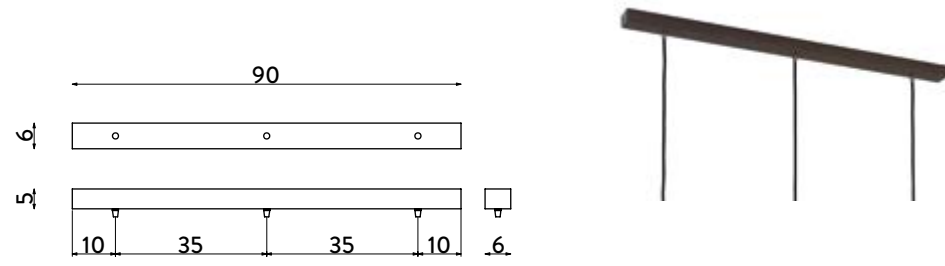



# COMPOSITION on SLIM TRACK

TO CREATE A CUSTOM COMPOSITION: TAKE THE PRICES OF THE PRODUCTS WITHOUT CANOPY AND ADD THE PIECES HERE BELOW

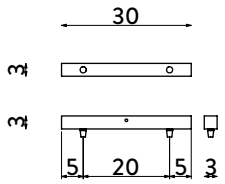

FOR CUSTOMIZED TRACKS CONTACT OUR TECHNICAL OFFICE AT [info@canginietucci.com](mailto:info@canginietucci.com)

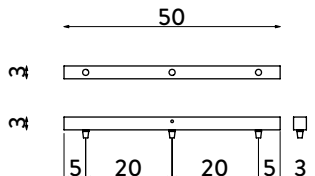
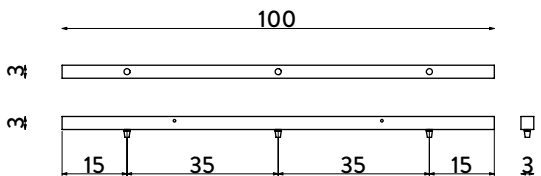
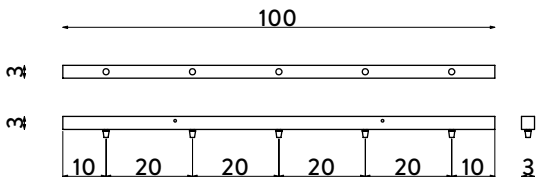
CODE	DESCRIPTION	€ CHROME / WHITE / BLACK / BRUSHED	€ GOLD/SILVER LEAF
SLIM30	SLIM TRACK 30 cm (2 BULBS) <div style="display: flex; align-items: center; margin-top: 10px;">   </div>	<b>59,00</b>	<b>+53,00</b>
SLIM50	SLIM TRACK 50 cm (3 BULBS) <div style="display: flex; align-items: center; margin-top: 10px;">  </div>	<b>102,00</b>	<b>+63,00</b>
SLIM100	SLIM TRACK 100 cm (3-5 BULBS) <div style="display: flex; align-items: center; margin-top: 10px;">  </div> <div style="display: flex; align-items: center; margin-top: 10px;">  </div>	<b>142,00</b>	<b>+98,00</b>

# COMPOSITION on SLOT TRACK

TO CREATE A CUSTOM COMPOSITION: TAKE THE PRICES OF THE PRODUCTS WITHOUT CANOPY AND ADD THE PIECES HERE BELOW



FOR CUSTOMIZED TRACKS CONTACT OUR TECHNICAL OFFICE AT [info@canginietucci.com](mailto:info@canginietucci.com)

CODE	DESCRIPTION		€ CHROME / WHITE / BLACK / BRUSHED
60T	TRACK WITH SLOT 60 cm		235,00
100T	TRACK WITH SLOT 100 cm		248,00
130T	TRACK WITH SLOT 130 cm		262,00
150T	TRACK WITH SLOT 150 cm		286,00
200T	TRACK WITH SLOT 200 cm		377,00





# COMPOSITION on TAO TRACK

TO CREATE A CUSTOM COMPOSITION: TAKE THE PRICES OF THE PRODUCTS WITHOUT CANOPY AND ADD THE PIECES HERE BELOW

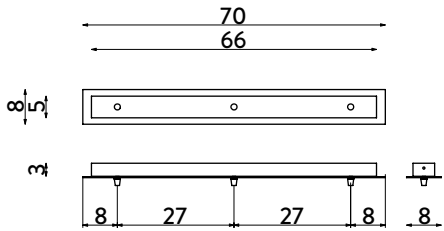
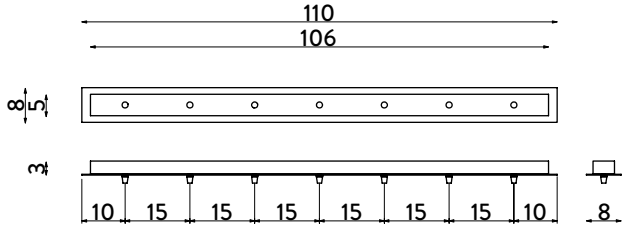

FOR CUSTOMIZED TRACKS CONTACT OUR TECHNICAL OFFICE AT [info@canginetucci.com](mailto:info@canginetucci.com)

CODE	DESCRIPTION	€ CHROME / WHITE / BLACK / BRUSHED	€ GOLD/SILVER LEAF
			
<b>TAO70</b>	TAO TRACK 70 cm (3 BULBS)	142,00	+88,00
			
<b>TAO110</b>	TAO TRACK 110 cm (7 BULBS)	180,00	+101,00
			

## WE REALIZE CUSTOMIZED PROJECTS

Please contact the technical office by email at the address [info@canginietucci.com](mailto:info@canginietucci.com) for a quote.



Upon request, we can supply customized plates and tracks of the diameter or length you need, and with a number of different outputs depending on the composition.

As an alternative to special plates and tracks, there is the possibility of closing the holes with a plug of the same colour of the structure.



## CUSTOM TRACKS (AUF AND SLIM)

TO CREATE A CUSTOM COMPOSITION: TAKE THE PRICES OF THE PRODUCTS WITHOUT CANOPY AND ADD THE PIECES HERE BELOW

DESCRIPTION	€ CHROME / WHITE / BLACK / BRUSHED	€ GOLD/SILVER LEAF
TRACK from 50 cm to 100 cm 	336,00	+98,00
TRACK from 101 cm to 150 cm 	389,00	+125,00
TRACK from 151 cm to 200 cm 	432,00	+149,00

# UP&DOWN SYSTEM (available only in black finish)

TO CREATE A CUSTOM COMPOSITION: TAKE THE PRICES OF THE PRODUCTS WITHOUT CANOPY AND ADD THE PIECES HERE BELOW

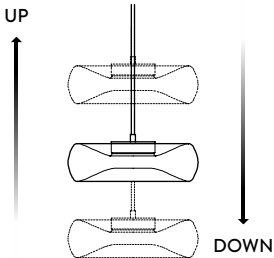
CODE	DESCRIPTION		€ BLACK FINISH
UD2	<b>CANOPY</b> in aluminum <b>FOR UP&amp;DOWN SYSTEM</b> suitable for: FIJI® 1483 GIG1483 - FOLD® 1513 GIG1513		+119,00
UD1	<b>UP&amp;DOWN SYSTEM</b> - DISPONIBILE SOLO PER FIJI® 1483 GIG1483 - FOLD® 1513 GIG1513 (peso massimo 1,8kg) AVAILABLE ONLY FOR FIJI® 1483 GIG1483 - FOLD® 1513 GIG1513 (maximum weight 1,8kg) - CAVO DISPONIBILE IN NERO diam. 2,1mm CABLE AVAILABLE IN BLACK diam. 2,1mm - CAVO COASSIALE 0,24M2 / COAXIAL CABLE 0,24M2 - REGOLAZIONE: lunghezza minima ca. 0,55m - lunghezza massima 1,90m ADJUSTMENT: minimum length ca. 0,55m / maximum length 1,90m		+358,00

# CASAMBI CONTROLLERS

TO CREATE A CUSTOM COMPOSITION: TAKE THE PRICES OF THE PRODUCTS WITHOUT CANOPY AND ADD THE PIECES HERE BELOW

CODE	DESCRIPTION		
CBU-TED	CASAMBI control unit DIMMER TRIAC 0-100		ON DEMAND







## CONDITIONS OF SALE

---

The current price list replaces all previous ones.  
The prices are in € EURO without VAT.

### **PACKAGING**

Packing costs in cardboard boxes are included in the price.

### **ORDERS**

Cancellations of already sent and confirmed orders are not accepted except for written arrangements between the parties.  
Cancellations of orders concerning special fixtures are not accepted.  
The company reserves the right to make design changes to improve the products at any time and without notice.

### **COMPLAINTS AND RETURNS**

The company is not responsible for possible breaks or losses during the transportation of its products. Any possible complaint will have to be submitted within eight days from the receipt of the goods by registered letter or by fax or by e-mail. Return of materials is not accepted unless authorized in writing beforehand; the goods have to be delivered in perfect conditions, not being used and into their original packages.  
The client must CHECK the PACKAGING INTEGRITY. In case of missing signature “goods accepted under reserve” on the document, the goods will not be replaced.

### **RESERVE OF PROPERTY**

The manufacturer is the owner of the goods till they have been fully paid.

### **FURTHER CLAUSES**

The prices with E14 E27 and G9 lampholder indicated in the pricelist do not include bulbs.  
The company doesn't sell bulbs.  
All models are in compliance with legal standards and regulations.  
We do not take the responsibility for damages resulting from the improper use of the devices.

---



---

**L'AZIENDA SI RISERVA IL DIRITTO DI APPORTARE MODIFICHE ATTE AL MIGLIORAMENTO  
DEL PRODOTTO IN QUALSIASI MOMENTO E SENZA PREAVVISO**

*THE COMPANY RESERVES THE RIGHT TO MAKE DESIGN CHANGES  
TO IMPROVE THE PRODUCTS AT ANY TIME AND WITHOUT NOTICE.*

---







**CANGINI&TUCCI S.r.l**

Via Archimede, 36  
47521 Cesena (FC)  
Tel. +39 0547 303035  
Fax +39 0547 645146

[info@canginietucci.com](mailto:info@canginietucci.com)  
[www.canginietucci.com](http://www.canginietucci.com)